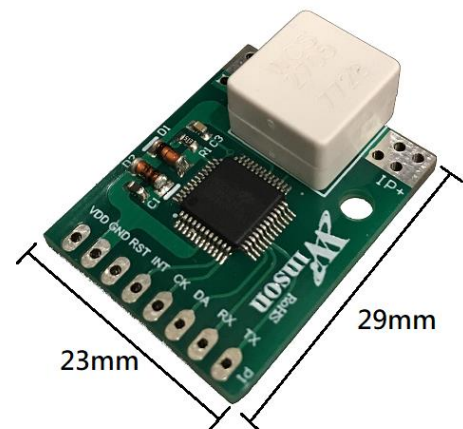

AC / DC Sensing Current Module with Digital Data output**Feature:**

- Continuous output and Modbus-RTU version
- Operating voltage DC5.0V
- 0.4 mΩ internal conductor resistance
- Sensing current range :
AC : 0~20A (50Hz, 60Hz)
DC : 0~±25A
- High accuracy :
AC : (0~6A) ± 60mA
 (6~20A) ± 1%
DC : ±(0~6A) ± 60mA
 ±(6~25A) ± 1%
- High resolution :
AC / DC : 18mA
- UART, Baud Rate : 9600 bps, Parity bit : None , Data bit : 8 , Stop bit : 1
- Temperature calibration
- Isolation Voltage 1KV
- Application note: <http://www.winson.com.tw/Product/83>

**General Description:**

The Winson WCM2720 provides economical and precise solution for both AC and DC current sensing in industrial, commercial and communications systems.

The WCM2720 consists of a current sensor, temperature sensor, a very high accuracy A/D converter and digital signal output of current.

The WCM2720 includes a current path with 0.4mΩ typical internal conductor resistance. This extremely low resistance can effectively reduce power loss, operating temperature and increase the reliability greatly, user's MCU can get the real data from DATA pin.

The WCM2720 provides temperature calibration of the internal current sensor and accurately measures the current of AC 50 / 60Hz and DC at temperature from -20°C~70°C. The WCM2720 also offers solutions for true RMS current measurement of various loads.

Winson reserves the right to make changes to improve reliability or manufacturability.



1.VDD 2.GND 3.RST 4.INT 5.CK 6.DA 7.RX 8.TX

ABSOLUTE MAXIMUM RATING

Supply Voltage, Vdd	-----	6V
Pass Current, IP	-----	60A
Basic Isolation Voltage	-----	1000V
Operating Temperature Range, Ta	-----	
	-----	-20°C to +70°C
Storage Temperature Range, Ts	-----	
	-----	-50°C to +125°C

Selection Guide:

Model	Maximum Current		Operating Voltage	mode
	AC	DC		
WCM2720-AC50C	20A	-	5.0V	Continuous
WCM2720-DC50C		±25A	5.0V	Continuous
WCM2720-50C	20A	±25A	5.0V	Continuous
WCM2720-50M	20A	±25A	5.0V	Modbus-RTU

Pad Description:

Pad No	Pad Name	I/O	Description
1	VDD	-	The positive power input pin
2	GND	-	The system ground
3	RST	I	The system reset
4	INT	I	Sampling control
5	CK	I/O	System programming, reserve
6	DA	I/O	
7	RX	I	The data of measured current output. Its output is UART communication. The baud rate is 9.6K bits/sec.
8	TX	O	

Winson reserves the right to make changes to improve reliability or manufacturability.

Electrical Characteristics:
Common Operating Characteristics

Symbol	Parameter	Test Condition	Min.	Typ.	Max.	Unit
VDD	Operation Voltage	-	4.9	5	5.1	V
IDD	Operation Current	-	-	6	8	mA
R _{primary}	Conductor Resistance	IP = 10 A	-	0.5	-	mΩ
TOP	Operating Temperature	-	-20	-	70	°C

-AC50C
T_{OP} = 25 °C, V_{DD} = 5.000V

Symbol	Parameter	Test Condition	Min.	Typ.	Max.	Unit
IOP	AC Current Range	-	0	-	20	A
ETOT	AC Current Total Output Error	IOP=0~6A, TOP=25°C	-	±60	-	mA
		IOP=6~20A, TOP=25°C	-	±1	-	%
		IOP=0~20A , TOP=-20°C to 70°C	-	±5	-	%

-DC50C
T_{OP} = 25 °C, V_{DD} = 5.000V

Symbol	Parameter	Test Condition	Min.	Typ.	Max.	Unit
IOP	DC Current Range	-	0	-	±25	A
ETOT	DC Current Total Output Error	IOP=±(0~6A), TOP=25°C	-	±60	-	mA
		IOP=±(6~25A), TOP=25°C	-	±1	-	%
		IOP=0~±25A , TOP=-20°C to 70°C	-	±5	-	%

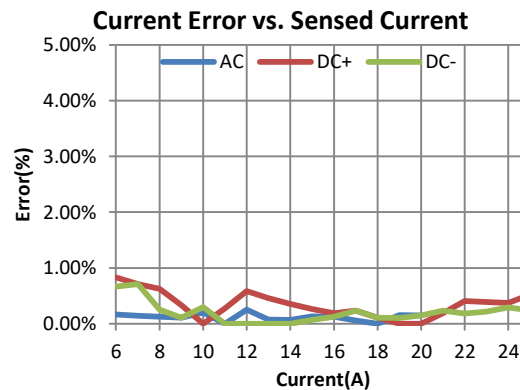
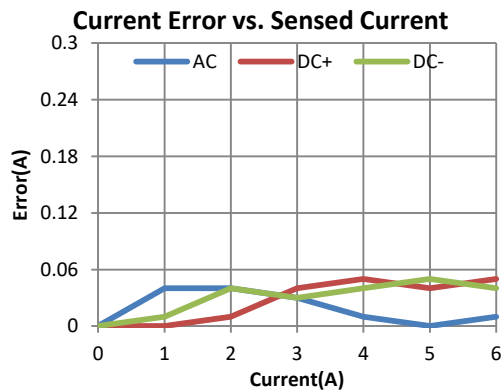

Winson reserves the right to make changes to improve reliability or manufacturability.

Application Note:

Application Diagram:

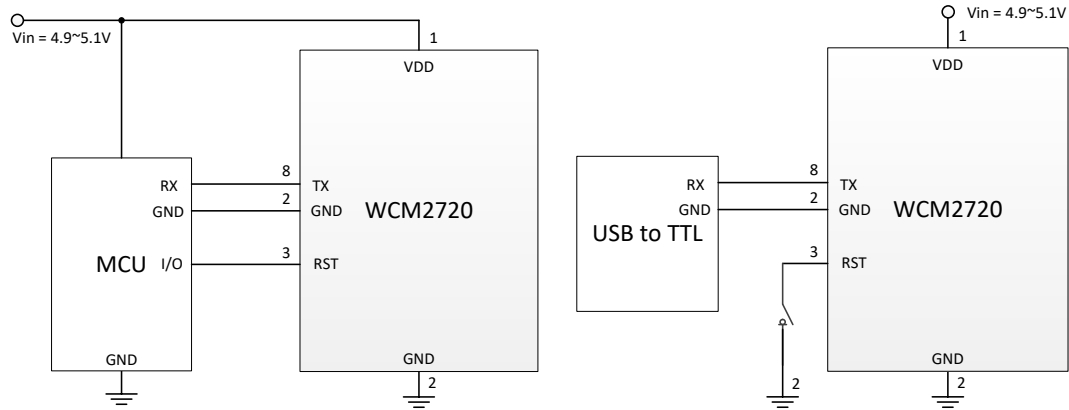

APP. 1. Output UART signal with MCU

APP. 2. Output UART signal with USB to TTL

Measured Current Data Output (Continuous Mode):

The measured current can be **continuously transmitted** by UART format.

- (1) If the measured data is AC "1.23"A, then the output data is '~', '0', '1', '2', '3', '0', '\r', '\n', total of 8 bytes; the output data is ASCII code. If the measured data is "10.76" A, then the output data is '~', '1', '0', '7', '6', '0', '\r', '\n', total of 8 bytes.
- (2) If the measured data is +DC "1.23"A, then the output data is '+', '0', '1', '2', '3', '0', '\r', '\n', total of 8 bytes; the output data is ASCII code. If the measured data is "10.76" A, then the output data is '+', '1', '0', '7', '6', '0', '\r', '\n', total of 8 bytes.
- (3) If the measured data is -DC "1.23"A, then the output data is '-', '0', '1', '2', '3', '0', '\r', '\n', total of 8 bytes; the output data is ASCII code. If the measured data is "10.76" A, then the output data is '-', '1', '0', '7', '6', '0', '\r', '\n', total of 8 bytes.

Winson reserves the right to make changes to improve reliability or manufacturability.

Measured Current Data Output (Modbus-RTU Mode):
Modbus Parameter List

	Item	Address	Byte	R/W	Description
1	Reset	0x0000	2	Write	Input 256 to Reset
2	Current	0x0002	4	Read	Hexadecimal signed (HEX), Unit:0.001A Current= HEX / 1000 (A)
3	Temperature	0x0004	4	Read	Hexadecimal signed (HEX), Unit:0.1°C Temperature= HEX / 10 (°C)
4	Slave Address	0x0010	2	Read/ Write	Default address: 1 Input address1~247

For example description, please refer to the "Current Module Application Note":

Modbus-RTU Data Format

Slave Address	Function Code	Data	Check Code (CRC16)
1 Byte	1 Byte	N x Byte	2 Byte (Low byte first)

Function Code

Function Code	Description
03H	Read up to 125 continuous memory words
06H	Write one memory word

Exception Code

Exception Code	Description
01H	Illegal function code
02H	Illegal data address
03H	Illegal data count

When responding to an exception, the MSB (Most Significant Bit) of the function code is automatically set to 1.

Winson reserves the right to make changes to improve reliability or manufacturability.

True RMS Current Measurement:

In order to calculate true RMS of AC current, you need to know “zero” value of AC current first. The “zero” value of symmetric AC current is the average value $V_o(dc)$ of the current shown in Figure 1.

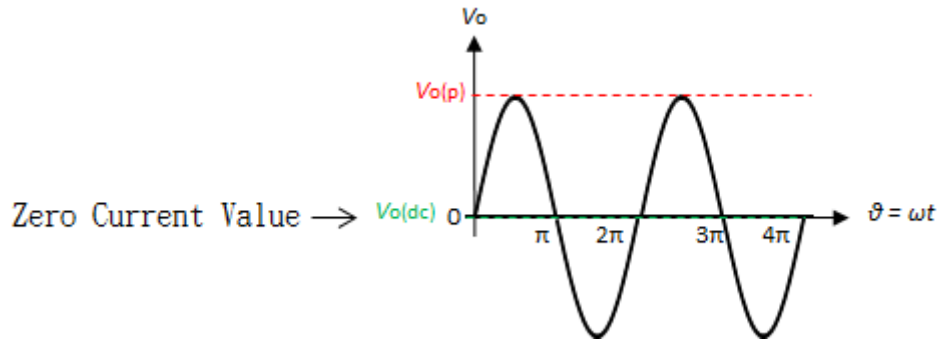

Figure 1 The zero current value of sine waveform

But in asymmetrical AC current, the “zero” value is not the average value $V_o(dc)$ of the current. Based on this “zero” value and do RMS calculation. You will get wrong answer.

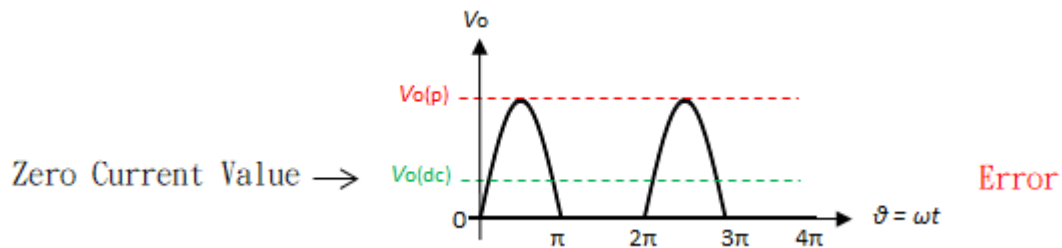

Figure 2 The zero current value of the asymmetric waveform (Error)

The WCM2720 offers a true RMS solution for both symmetric and asymmetric AC current. It can correctly detect “zero” current value, shown in Figure 3. and do perfect RMS calculation.

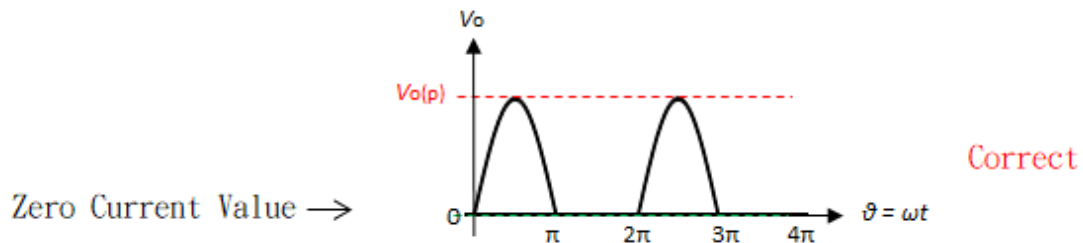
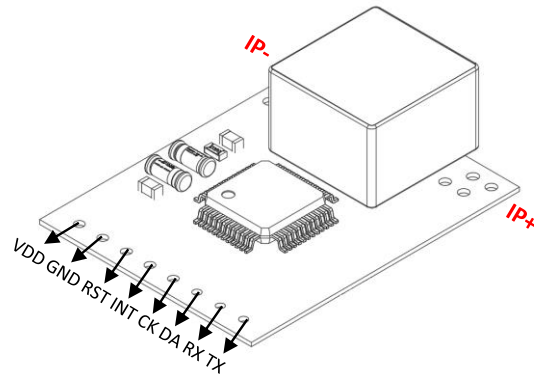
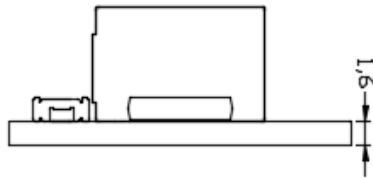
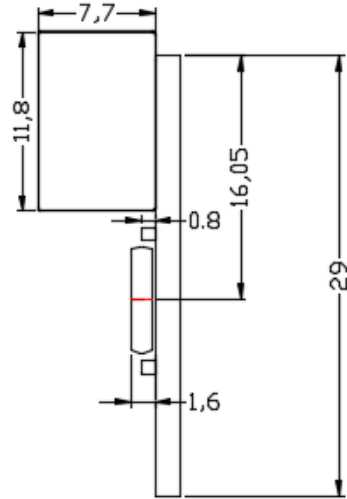
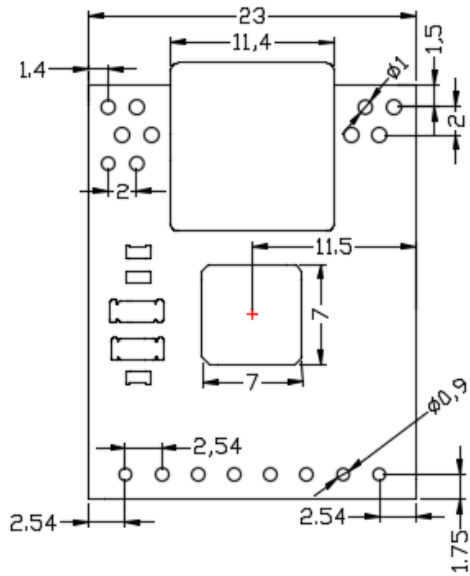

Figure 3 The zero current value of the asymmetric waveform (Correct)

Package:

(Unit: mm)



Winson reserves the right to make changes to improve reliability or manufacturability.