

Ultra-Low On-Resistance, Power Load Switch with Soft Start

Features

- **Ultra-Low On-Resistance:**
 - $R_{DS(ON)}=10.5m\Omega$ at $V_{IN}=5V$
 - $R_{DS(ON)}=12m\Omega$ at $V_{IN}=3.6V$
 - $R_{DS(ON)}=12.5m\Omega$ at $V_{IN}=1.8V$
 - $R_{DS(ON)}=17.5m\Omega$ at $V_{IN}=1V$
- **Ultra-Low Quiescent Current: $V_{IN}=1V$ Condition, 10mA (Max.)**
- **3A Maximum Continuous Output Current**
- **Supply Voltage Range from 0.95V to 5.5V**
- **Built in Internal Charge Pump Function for Internal Gate Driver**
- **Built in Internal Soft-Start Function: $V_{IN} = 3.6V$ Condition, A: 96ms, B: 800ms (Typ.)**
- **Built in Enable/Shutdown Control**
- **Built in Turn On Time: $V_{IN} = 3.6V$ Condition, A: 111ms, B: 860ms (Typ.)**
- **Output Discharge when Switch Disabled**
- **Built in Reverse Current Block Function**
- **Tiny small WLCSP 0.9x1.4-6 Package**
- **Lead Free and Green Devices Available (RoHS Compliant)**

General Description

The APL3537 is an ultra-low on-resistance, power-distribution switch with internal soft start control. The device is an N-channel MOSFET which needs only one input voltage from 0.95V to 5.5V. Built in internal charge pump function biases the N-MOS switch to achieve a minimum switch on-resistance. The APL3537 can be enabled by other power system. Pulling and holding the EN pin below 0.4V shuts off the output.

The device is available in lead free WLCSP 0.9x1.4-6 package.

Pin Configuration

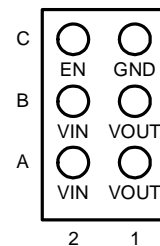

WLCSP 0.9x1.4-6
(Top View)

Applications

- Notebooks
- AIO PC
- Tablet PCs
- GPS Devices
- Smartphones

Simplified Application Circuit

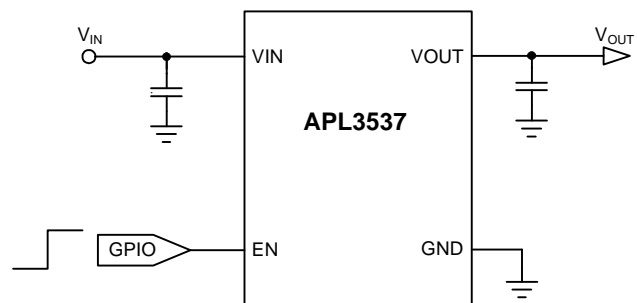

ANPEC reserves the right to make changes to improve reliability or manufacturability without notice, and advise customers to obtain the latest version of relevant information to verify before placing orders.

Ordering and Marking Information

<p>APL3537 □□□□ - □□□□</p> <p> □□□□ — Assembly Material □□□□ — Handling Code □□□□ — Temperature Range □□□□ — Package Code □□□□ — Product Code </p>	<p>Product Code</p> <p>A : Turn On Delay 111μs B : Turn On Delay 800μs</p> <p>Package Code</p> <p>HA : WLCSP0.9x1.4-6</p> <p>Operating Junction Temperature</p> <p>I : -40 to 85 °C</p> <p>Handling Code</p> <p>TR : Tape & Reel</p> <p>Assembly Material</p> <p>G : Halogen and Lead Free Device</p>
<p>APL3537A HA: </p>	<p>X - Date Code</p>
<p>APL3537B HA: </p>	<p>X - Date Code</p>

Note : ANPEC lead-free products contain molding compounds/die attach materials and 100% matte tin plate termination finish; which are fully compliant with RoHS. ANPEC lead-free products meet or exceed the lead-free requirements of IPC/JEDEC J-STD-020D for MSL classification at lead-free peak reflow temperature. ANPEC defines "Green" to mean lead-free (RoHS compliant) and halogen free (Br or Cl does not exceed 900ppm by weight in homogeneous material and total of Br and Cl does not exceed 1500ppm by weight).

WLCSP 0.9x1.4-6 Marking (Top View)

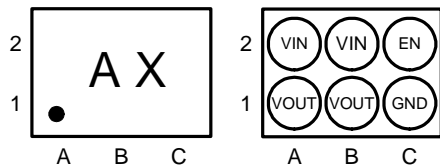

Absolute Maximum Ratings (Note 1)

Symbol	Parameter	Rating	Unit
V _{IN}	VIN to GND Voltage	-0.3 ~ 6	V
V _{OUT}	VOUT to GND Voltage	-0.3 ~ 6	V
V _{EN}	EN to GND Voltage	-0.3 ~ 6	V
P _D	Maximum Power Dissipation, T _A ≤ 25°C <small>(Note2)</small>	1	W
T _J	Maximum Junction Temperature	-40 ~ 150	°C
T _{STG}	Storage Temperature	-65 ~ 150	°C
T _{SDR}	Maximum Lead Soldering Temperature (10 Seconds)	260	°C

Note1: Stresses beyond those listed under "absolute maximum ratings" may cause permanent damage to the device. These are stress ratings only and functional operation of the device at these or any other conditions beyond those indicated under "recommended operating conditions" is not implied. Exposure to absolute maximum rating conditions for extended periods may affect device reliability.

Note2: Refer to the thermal consideration on page 14.

Thermal Characteristics

Symbol	Parameter	Typical Value	Unit
θ_{JA}	Junction-to-Ambient Thermal Resistance in free air ^(Note 3)	125	°C/W
θ_{JC}	Junction-to-Case Thermal Resistance in free air ^(Note 3)	18	°C/W

Note 3: θ_{JA} is measured with the component mounted on a high effective thermal conductivity test board in free air.

Recommended Operating Conditions ^(Note 4)

Symbol	Parameter	Range	Unit
V_{IN}	VIN Input Voltage	0.95 ~ 5.5	V
I_{OUT}	OUT Output Current	0 ~ 3	A
I_{PEAK}	Maximum Peak Current, 100 μ s pluse with 2% duty cycle	4	A
P_D	Maximum Power Dissipation, $T_A \leq 25^\circ\text{C}$ ^(Note 2)	0.8	W
	Maximum Power Dissipation, $T_A < 50^\circ\text{C}$ ^(Note 2)	0.6	W
	Maximum Power Dissipation, $T_A \leq 85^\circ\text{C}$ ^(Note 2)	0.32	W
V_{IH}	EN Logic High Input Voltage	0.9 ~ 5.5	V
V_L	EN Logic Low Input Voltage	0 ~ 0.4	V
C_{OUT}	Output Capacitor	0.1 ~ 10	μ F
T_A	Ambient Temperature	-40 ~ 85	°C
T_J	Junction Temperature	-40 ~ 125	°C

Note 4: Please refer to the typical application circuit.

Electrical Characteristics

Unless otherwise specified, these specifications apply over $V_{IN} = 1\sim 5\text{V}$, $V_{EN} = 3.6\text{V}$ and $T_A = -40\sim 85^\circ\text{C}$. Typical values are at $T_A = 25^\circ\text{C}$.

Symbol	Parameter	Test Conditions	APL3537			Unit
			Min	Typ	Max	
SUPPLY CURRENT						
I_{VIN}	VIN Supply Current	No load, $V_{IN}=5\text{V}$	-	50	90	μ A
		No load, $V_{IN}=3.6\text{V}$	-	25	45	μ A
		No load, $V_{IN}=1.8\text{V}$	-	10	20	μ A
		No load, $V_{IN}=1.2\text{V}$	-	7	15	μ A
		No load, $V_{IN}=1\text{V}$	-	5	10	μ A
I_{SD}	VIN Supply Current at Shutdown	No load, $V_{IN}=5\text{V}$, $V_{EN}=0\text{V}$	-	0.1	2	μ A
		No load, $V_{IN}=3.6\text{V}$, $V_{EN}=0\text{V}$	-	0.1	1.8	μ A
		No load, $V_{IN}=1\text{V}$, $V_{EN}=0\text{V}$	-	0.1	1.5	μ A
		No load, $V_{EN}=0\text{V}$, $V_{IN}=1\sim 5\text{V}$, $T_J=25^\circ\text{C}$	-	0.1	1	μ A
	VOOUT Leakage Current	No load, $V_{IN}=5\text{V}$, $V_{EN}=0\text{V}$	-	0.1	1.5	μ A
		No load, $V_{IN}=3.6\text{V}$, $V_{EN}=0\text{V}$	-	0.1	1.3	μ A
		No load, $V_{IN}=1\text{V}$, $V_{EN}=0\text{V}$	-	0.1	1	μ A
	Reverse Leakage Current	$V_{EN}=0\text{V}$, $V_{IN}=\text{GND}$, $V_{OUT}=5\text{V}$	-	0.1	2	μ A
		$V_{EN}=0\text{V}$, $V_{IN}=\text{GND}$, $V_{OUT}=3.6\text{V}$	-	0.1	1.8	μ A
		$V_{EN}=0\text{V}$, $V_{IN}=\text{GND}$, $V_{OUT}=1\text{V}$	-	0.1	1.5	μ A
		$V_{EN}=0\text{V}$, $V_{IN}=\text{GND}$, $V_{OUT}=3.3$ or 5V , $T_J=25^\circ\text{C}$	-	0.1	1	μ A

Electrical Characteristics

Unless otherwise specified, these specifications apply over $V_{IN} = 1\sim 5V$, $V_{EN} = 3.6V$ and $T_A = -40\sim 85^\circ C$. Typical values are at $T_A = 25^\circ C$.

Symbol	Parameter	Test Conditions	APL3537			Unit
			Min	Typ	Max	
POWER SWITCH						
$R_{DS(ON)}$	Power Switch On Resistance	$V_{IN}=5V, I_{OUT}=200mA, T_J=25^\circ C$	-	10.5	14	mΩ
		$V_{IN}=5V, I_{OUT}=200mA, T_J=-40\sim 125^\circ C$	-	-	19	mΩ
		$V_{IN}=3.6V, I_{OUT}=200mA, T_J=25^\circ C$	-	12	16	mΩ
		$V_{IN}=3.6V, I_{OUT}=200mA, T_J=-40\sim 125^\circ C$	-	-	21.5	mΩ
		$V_{IN}=1.8V, I_{OUT}=200mA, T_J=25^\circ C$	-	12.5	16.5	mΩ
		$V_{IN}=1.8V, I_{OUT}=200mA, T_J=-40\sim 125^\circ C$	-	-	22.5	mΩ
		$V_{IN}=1.2V, I_{OUT}=200mA, T_J=25^\circ C$	-	16	19	mΩ
		$V_{IN}=1.2V, I_{OUT}=200mA, T_J=-40\sim 125^\circ C$	-	-	26	mΩ
		$V_{IN}=1.0V, I_{OUT}=200mA, T_J=25^\circ C$	-	17.5	21	mΩ
		$V_{IN}=1.0V, I_{OUT}=200mA, T_J=-40\sim 125^\circ C$	-	-	28.5	mΩ
SOFT-START CONTROL						
t_{SS}	Soft-Start Time (APL3537A) (Note 5)	$V_{IN}=5V, R_L=10\Omega, C_{OUT}=0.1\mu F$	-	50	-	μs
		$V_{IN}=3.6V, R_L=10\Omega, C_{OUT}=0.1\mu F$	-	55	-	μs
		$V_{IN}=1.8V, R_L=10\Omega, C_{OUT}=0.1\mu F$	-	60	-	μs
		$V_{IN}=1.2V, R_L=10\Omega, C_{OUT}=0.1\mu F$	-	112	-	μs
		$V_{IN}=1V, R_L=10\Omega, C_{OUT}=0.1\mu F$	-	200	-	μs
	Soft-Start Time (APL3537B) (Note 5)	$V_{IN}=5V, R_L=10\Omega, C_{OUT}=0.1\mu F$	-	950	-	μs
		$V_{IN}=3.6V, R_L=10\Omega, C_{OUT}=0.1\mu F$	-	1065	-	μs
		$V_{IN}=1.8V, R_L=10\Omega, C_{OUT}=0.1\mu F$	-	730	-	μs
		$V_{IN}=1.2V, R_L=10\Omega, C_{OUT}=0.1\mu F$	-	1020	-	μs
		$V_{IN}=1V, R_L=10\Omega, C_{OUT}=0.1\mu F$	-	1270	-	μs
t_F	VOUT Fall Time (APL3537A) (Note 5)	$V_{IN}=5V, R_L=10\Omega, C_{OUT}=0.1\mu F$	-	1.5	-	μs
		$V_{IN}=3.6V, R_L=10\Omega, C_{OUT}=0.1\mu F$	-	1.5	-	μs
		$V_{IN}=1V, R_L=10\Omega, C_{OUT}=0.1\mu F$	-	2	-	μs
	VOUT Fall Time (APL3537B) (Note 5)	$V_{IN}=5V, R_L=10\Omega, C_{OUT}=0.1\mu F$	-	1.5	-	μs
		$V_{IN}=3.6V, R_L=10\Omega, C_{OUT}=0.1\mu F$	-	1.5	-	μs
		$V_{IN}=1V, R_L=10\Omega, C_{OUT}=0.1\mu F$	-	2	-	μs
t_{ON}	Turn On Time (APL3537A) (Note 5)	$V_{IN}=5V, R_L=10\Omega, C_{OUT}=0.1\mu F$	-	50	-	μs
		$V_{IN}=3.6V, R_L=10\Omega, C_{OUT}=0.1\mu F$	-	60	-	μs
		$V_{IN}=1.8V, R_L=10\Omega, C_{OUT}=0.1\mu F$	-	75	-	μs
		$V_{IN}=1.2V, R_L=10\Omega, C_{OUT}=0.1\mu F$	-	140	-	μs
		$V_{IN}=1V, R_L=10\Omega, C_{OUT}=0.1\mu F$	-	240	-	μs

Electrical Characteristics

Unless otherwise specified, these specifications apply over $V_{IN} = 1\sim 5V$, $V_{EN} = 3.6V$ and $T_A = -40\sim 85^\circ C$. Typical values are at $T_A = 25^\circ C$.

Symbol	Parameter	Test Conditions	APL3537			Unit
			Min	Typ	Max	
POWER SWITCH						
t_{ON}	Turn On Time (APL3537B) (Note 5)	$V_{IN}=5V, R_L=10\Omega, C_{OUT}=0.1\mu F$	-	850	-	μs
		$V_{IN}=3.6V, R_L=10\Omega, C_{OUT}=0.1\mu F$	-	1080	-	μs
		$V_{IN}=1.8V, R_L=10\Omega, C_{OUT}=0.1\mu F$	-	840	-	μs
		$V_{IN}=1.2V, R_L=10\Omega, C_{OUT}=0.1\mu F$	-	1260	-	μs
		$V_{IN}=1V, R_L=10\Omega, C_{OUT}=0.1\mu F$	-	1600	-	μs
t_{OFF}	Turn Off Time (APL3537A) (Note 5)	$V_{IN}=5V, R_L=10\Omega, C_{OUT}=0.1\mu F$	-	1	-	μs
		$V_{IN}=3.6V, R_L=10\Omega, C_{OUT}=0.1\mu F$	-	1	-	μs
		$V_{IN}=1V, R_L=10\Omega, C_{OUT}=0.1\mu F$	-	3	-	μs
	Turn Off Time (APL3537B) (Note 5)	$V_{IN}=5V, R_L=10\Omega, C_{OUT}=0.1\mu F$	-	1	-	μs
		$V_{IN}=3.6V, R_L=10\Omega, C_{OUT}=0.1\mu F$	-	1	-	μs
		$V_{IN}=1V, R_L=10\Omega, C_{OUT}=0.1\mu F$	-	3	-	μs
EN INPUT PIN						
V_{IH}	EN Input Logic High		0.9	-	-	V
V_L	EN Input Logic Low		-	-	0.4	V
	EN Input Current	$V_{EN}=5.5V, V_{IN}=0V$	-	-	1	μA
	EN Leakage Current	$V_{EN}=0V, V_{IN}=5.5V$	-	-	1	μA
	VOUT Discharge Resistance	$V_{IN}=5V, V_{EN}=0V, V_{OUT}$ force 1V	-	30	50	Ω
		$V_{IN}=3.6V, V_{EN}=0V, V_{OUT}$ force 1V	-	40	60	Ω
		$V_{IN}=1.8V, V_{EN}=0V, V_{OUT}$ force 1V	-	115	150	Ω
		$V_{IN}=1V, V_{EN}=0V, V_{OUT}$ force 1V	-	700	1200	Ω

Note 5: Refer to the Timing Chart (See Figure 1).

Timing Chart

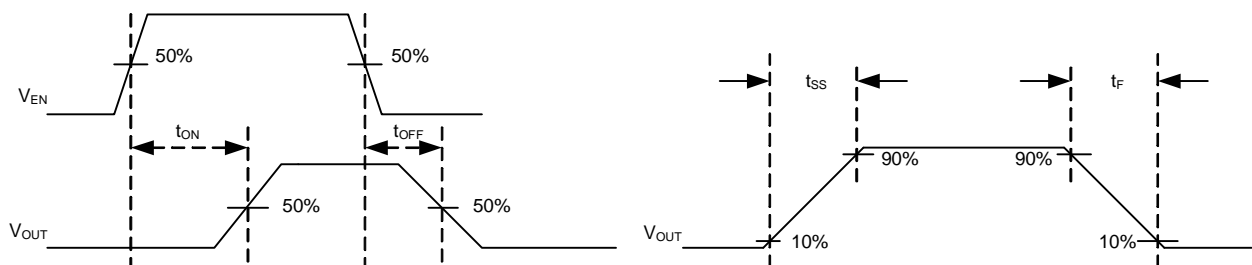

Note 6: t_{rise} and t_{fall} of the control signal is 100ns

Figure 1. $t_{on}/t_{off}, t_{SS}/t_F$ Waveforms

Pin Description

PIN		Function
NO.	NAME	
C1	GND	Ground pin of the circuitry. All voltage levels are measured with respect to this pin.
C2	EN	Enable input of switch. Logic high turns on switch. The EN pin cannot be left floating.
A1, B1	VOUT	Switch output.
A2, B2	VIN	Power supply Input of switch. Connect this pin to an external DC supply.

Block Diagram

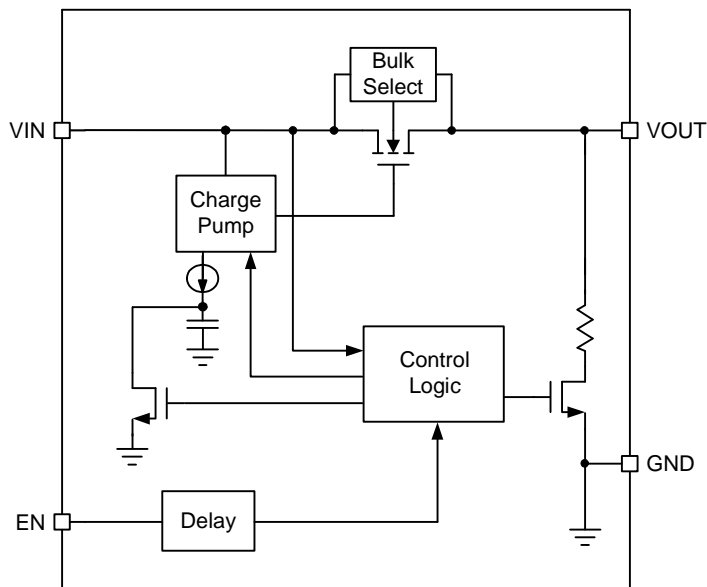

Typical Operating Characteristics

Power Switch On Resistance vs. VIN Input Voltage

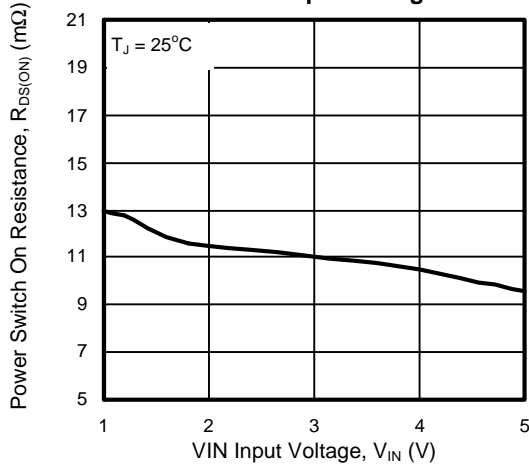

Power Switch On Resistance vs. Junction Temperature

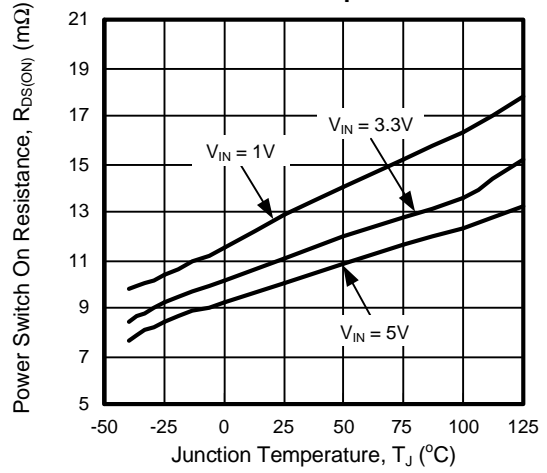

VIN Supply Current vs. VIN Input Voltage

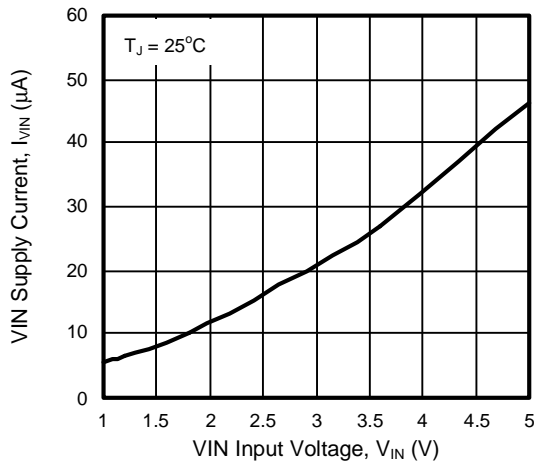

VIN Supply Current vs. Junction Temperature

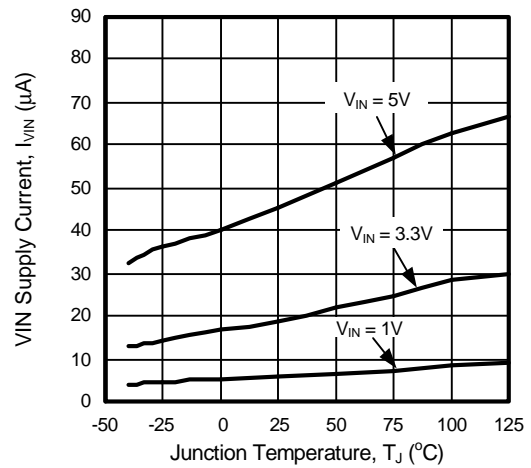

VIN Shutdown Current vs. Junction Temperature

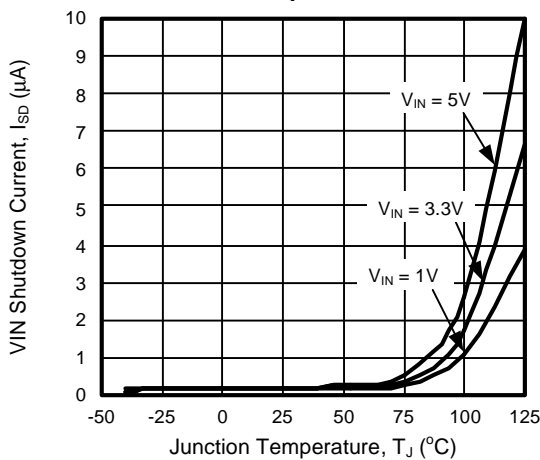

EN Logic Threshold Voltage vs. VIN Input Voltage

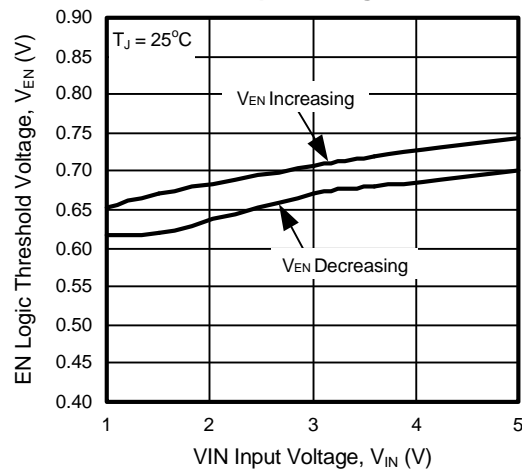

Typical Operating Characteristics

Soft-Start Time vs. Junction Temperature

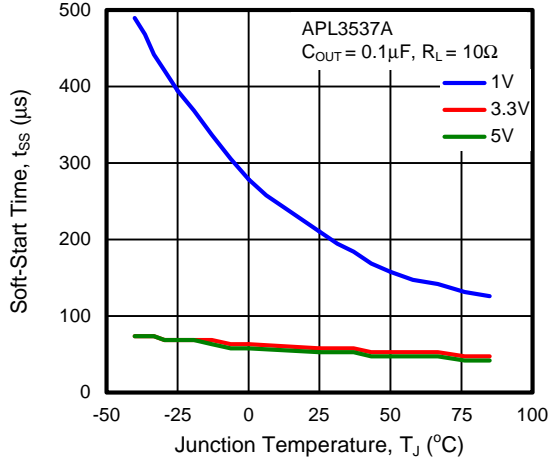

Soft-Start Time vs. Junction Temperature

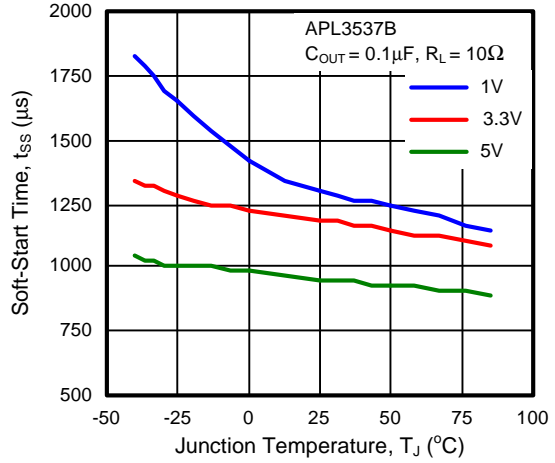

Turn On Time vs. Junction Temperature

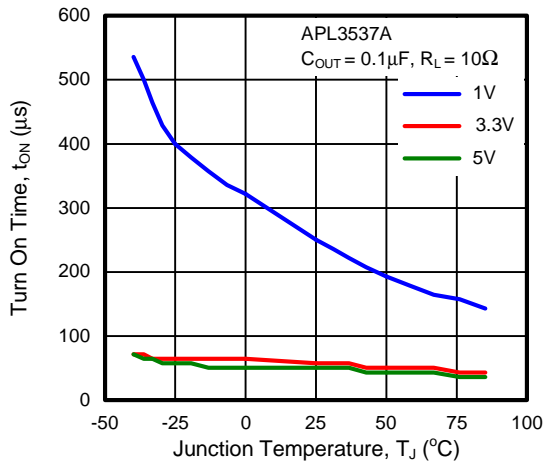

Turn On Time vs. Junction Temperature

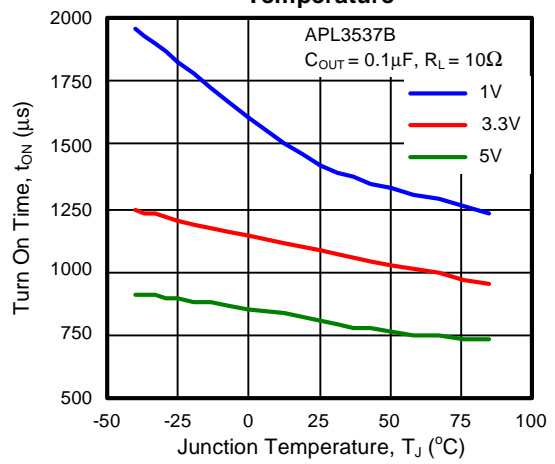

Operating Waveforms

Refer to the typical application circuit. $T_A = 25^\circ\text{C}$ unless otherwise specified.

Enable

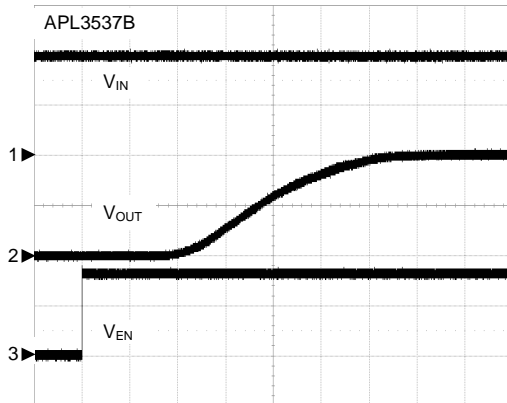

$V_{IN}=1\text{V}$, $C_{OUT}=0.1\mu\text{F}$, $R_L=10\Omega$
 CH1: V_{IN} , 500mV/Div, DC
 CH2: V_{OUT} , 500mV/Div, DC
 CH3: V_{EN} , 2V/Div, DC
 TIME: 0.5ms/Div

Shutdown

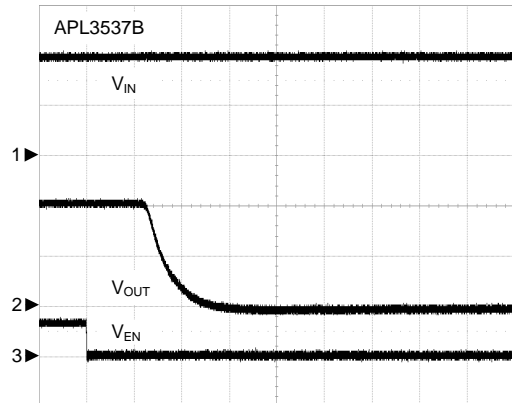

$V_{IN}=1\text{V}$, $C_{OUT}=0.1\mu\text{F}$, $R_L=10\Omega$
 CH1: V_{IN} , 500mV/Div, DC
 CH2: V_{OUT} , 500mV/Div, DC
 CH3: V_{EN} , 5V/Div, DC
 TIME: 2 μs /Div

Enable

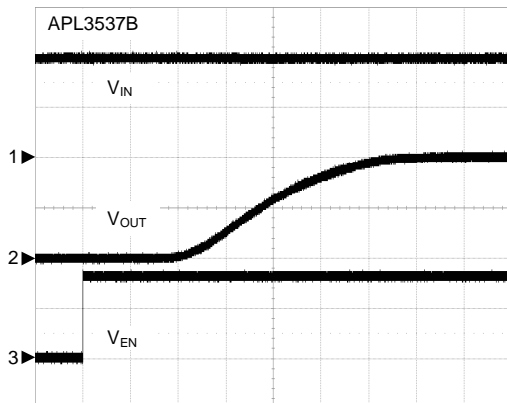

$V_{IN}=1\text{V}$, $C_{OUT}=1\mu\text{F}$, $R_L=10\Omega$
 CH1: V_{IN} , 500mV/Div, DC
 CH2: V_{OUT} , 500mV/Div, DC
 CH3: V_{EN} , 2V/Div, DC
 TIME: 0.5ms/Div

Shutdown

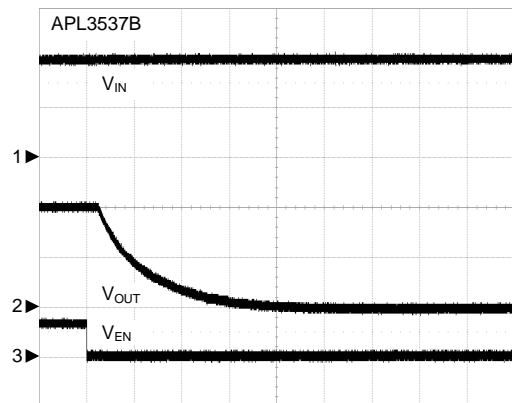

$V_{IN}=1\text{V}$, $C_{OUT}=1\mu\text{F}$, $R_L=10\Omega$
 CH1: V_{IN} , 500mV/Div, DC
 CH2: V_{OUT} , 500mV/Div, DC
 CH3: V_{EN} , 5V/Div, DC
 TIME: 10 μs /Div

Operating Waveforms

Refer to the typical application circuit. $T_A = 25^\circ\text{C}$ unless otherwise specified.

Enable

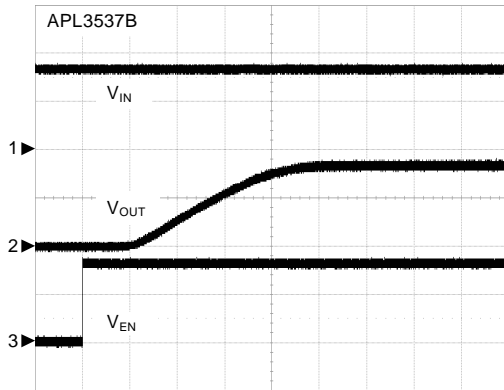

$V_{IN}=3.3\text{V}$, $C_{OUT}=0.1\mu\text{F}$, $R_L=10\Omega$
 CH1: V_{IN} , 2V/Div, DC
 CH2: V_{OUT} , 2V/Div, DC
 CH3: V_{EN} , 2V/Div, DC
 TIME: 0.5ms/Div

Shutdown

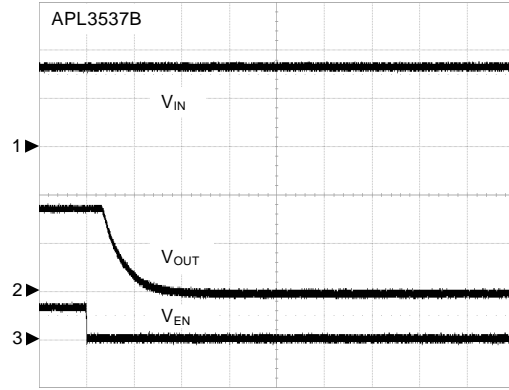

$V_{IN}=3.3\text{V}$, $C_{OUT}=0.1\mu\text{F}$, $R_L=10\Omega$
 CH1: V_{IN} , 2V/Div, DC
 CH2: V_{OUT} , 2V/Div, DC
 CH3: V_{EN} , 5V/Div, DC
 TIME: 2 μs /Div

Enable

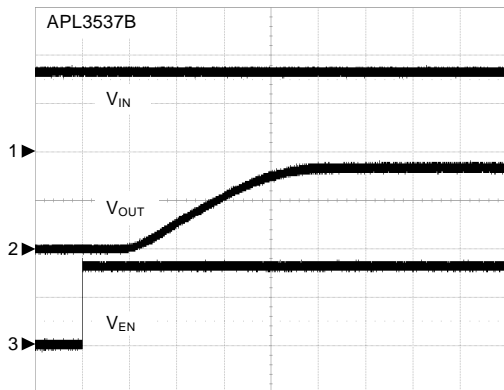

$V_{IN}=3.3\text{V}$, $C_{OUT}=1\mu\text{F}$, $R_L=10\Omega$
 CH1: V_{IN} , 2V/Div, DC
 CH2: V_{OUT} , 2V/Div, DC
 CH3: V_{EN} , 2V/Div, DC
 TIME: 0.5ms/Div

Shutdown

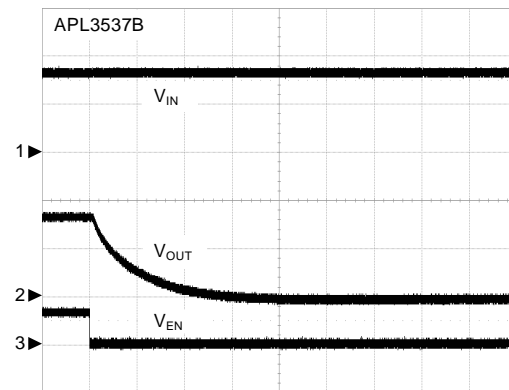

$V_{IN}=3.3\text{V}$, $C_{OUT}=1\mu\text{F}$, $R_L=10\Omega$
 CH1: V_{IN} , 2V/Div, DC
 CH2: V_{OUT} , 2V/Div, DC
 CH3: V_{EN} , 5V/Div, DC
 TIME: 10 μs /Div

Operating Waveforms

Refer to the typical application circuit. $T_A = 25^\circ\text{C}$ unless otherwise specified.

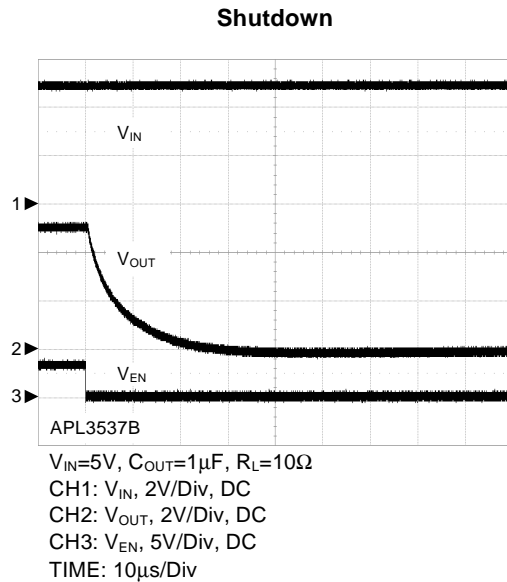
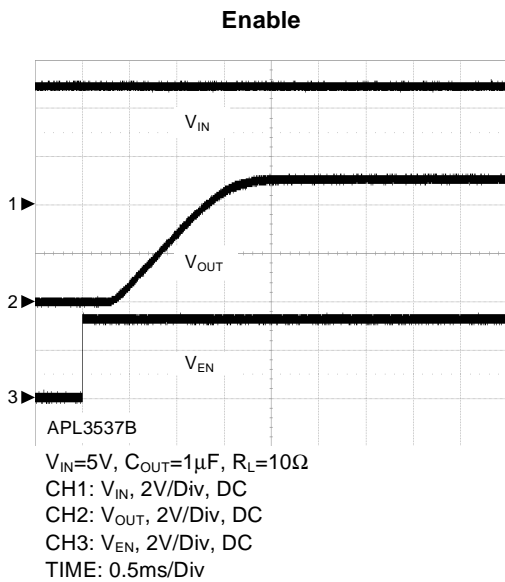
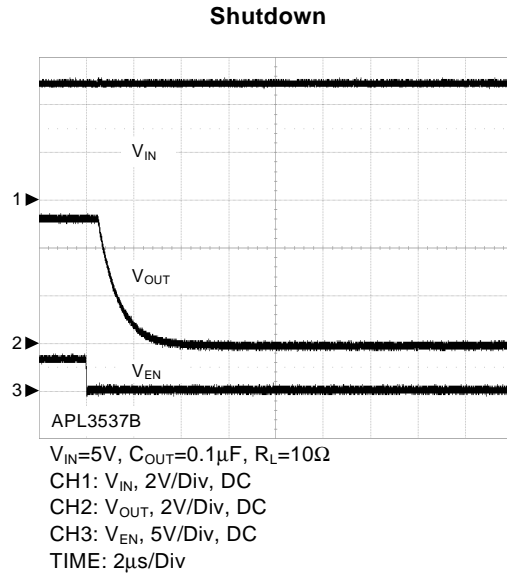
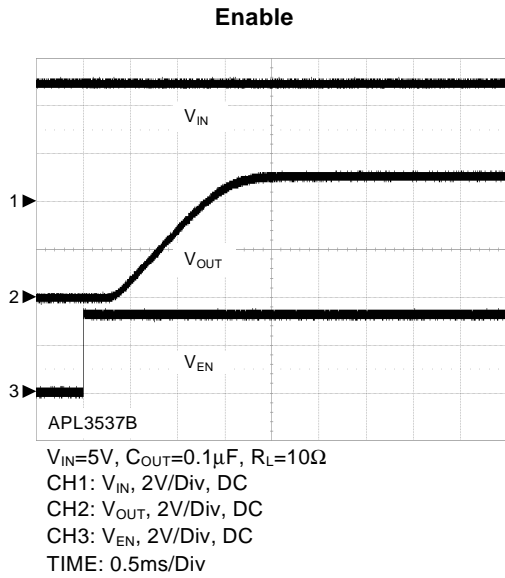

Typical Application Circuit

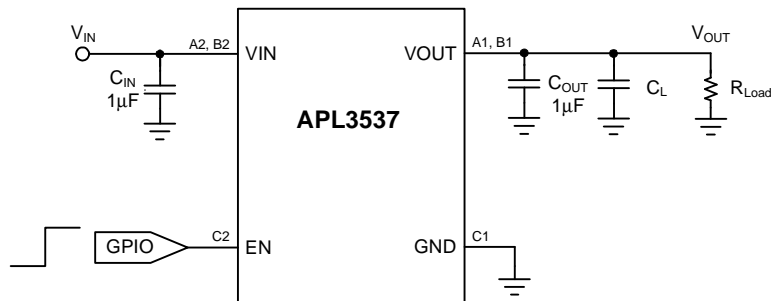

Function Description

Soft-Start

The APL3537 Provides a soft-start circuitry to control rise rate of the output voltage during start-up.

Enable Control

The APL3537 has a dedicated enable pin (EN). Pulling EN above 0.9V will enable the device, and pulling the EN below 0.4V will disable the device. Following a shutdown, a logic high signal re-enables the output through initiation of a new soft-start cycle. The enable input is compatible with standard GPIO logic threshold. (It can be used with any microcontroller with 1.2V, 1.8V, 2.5V, 3.3V GPIOs.) The EN pin cannot be left floating.

Output Discharge

When the EN input voltage is under 0.4V, the output discharge device is turned on discharge the output voltage.

Reverse Current Blocking Circuit

The APL3537 has a built-in reverse current blocking circuit to prevent a reverse current flowing through the body diode of power switch from the VOUT back VIN pin when power switch disabled.

Application Information

Power Sequencing

The power up/down sequence where VIN is already in steady state condition, and EN pin is asserted high or low to prevent wrong logic controls.

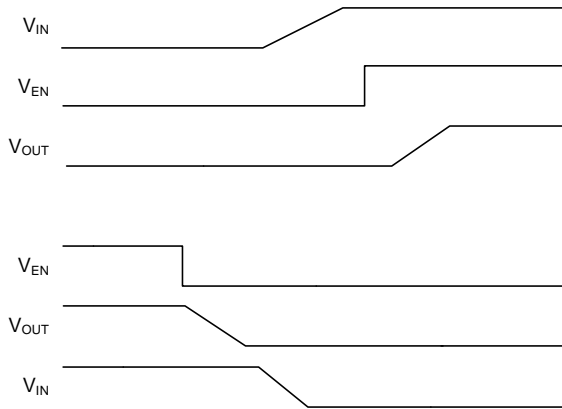

Figure 1. APL3537 Power Sequencing Diagram

Input Capacitor

The APL3537 requires proper input capacitance to supply current surge during stepping load transients to prevent the input voltage rail from dropping. Because the parasitic inductor from the voltage sources or other bulk capacitors to the VIN pin limit the slew rate of the surge currents, more parasitic inductance needs more input capacitance.

A 1μF or higher ceramic input capacitor from VIN to GND, located near the APL3537, is strongly recommended to suppress the ringing during load transient event. Without the input capacitor, the load transient may cause sufficient ringing on the input (from supply lead inductance) to damage internal control circuitry.

Additional input capacitance may be needed on the input to reduce voltage overshoot from exceeding the absolute maximum voltage of the device during load transient conditions.

Thermal Consideration

The APL3537 maximum power dissipation depends on the differences of the thermal resistance and temperature between junction and ambient air. The power dissipation P_D across the device is:

$$P_D = (T_J - T_A) / \theta_{JA}$$

Where the $(T_J - T_A)$ is the temperature difference between the junction and ambient air. θ_{JA} is the thermal resistance between junction and ambient air. Assuming the $T_A = 25^\circ\text{C}$ and maximum $T_J = 150^\circ\text{C}$, the maximum power dissipation is calculated as:

$$P_{D(\max)} = (150 - 25) / 125 = 1 \text{ (W)} \quad \text{----- for } T_A \leq 25^\circ\text{C}$$

For normal operation, do not exceed the maximum operating junction temperature of $T_J = 125^\circ\text{C}$. The calculated power dissipation should be less than:

$$P_D = (125 - 25) / 125 = 0.8 \text{ (W)} \quad \text{----- for } T_A \leq 25^\circ\text{C}$$

$$P_D = (125 - 85) / 125 = 0.32 \text{ (W)} \quad \text{----- for } T_A \leq 85^\circ\text{C}$$

Layout Consideration

The PCB layout should be carefully performed to maximize thermal dissipation and to minimize voltage drop, droop and EMI. The following guidelines must be considered:

1. Please place the input capacitors near the VIN pin as close as possible.
2. Output decoupling capacitors for load must be placed near the load as close as possible for decoupling high frequency ripples.
3. Locate APL3537 and output capacitors near the load to reduce parasitic resistance and inductance for excellent load transient performance.
4. The negative pins of the input and output capacitors and the GND pin must be connected to the ground plane of the load.
5. Keep VIN and VOUT traces as wide and short as possible.

Application Information (Cont.)

Recommended Minimum Footprint

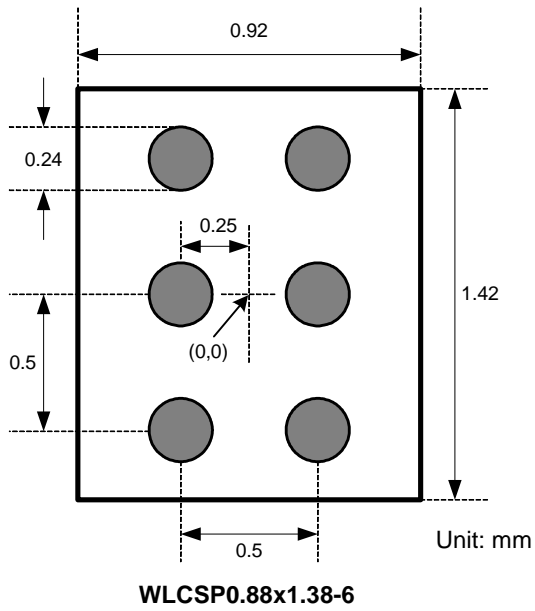

Package Information

WLCSP0.88x1.38-6

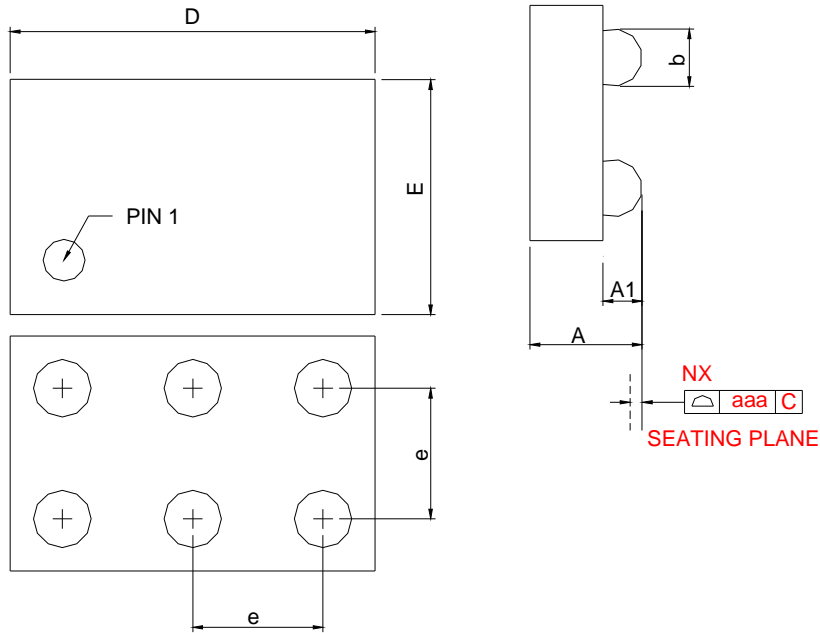

S Y M B O L	WLCSP0.88*1.38-6			
	MILLIMETERS		INCHES	
	MIN.	MAX.	MIN.	MAX.
A	0.38	0.47	0.015	0.019
A1	0.13	0.17	0.005	0.007
b	0.20	0.24	0.008	0.009
D	1.38	1.46	0.054	0.057
E	0.88	0.96	0.035	0.038
e	0.50 BSC		0.020 BSC	
aaa	0.08		0.003	

Carrier Tape & Reel Dimensions

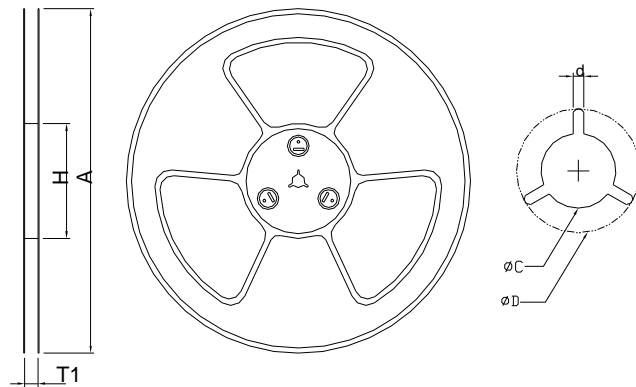
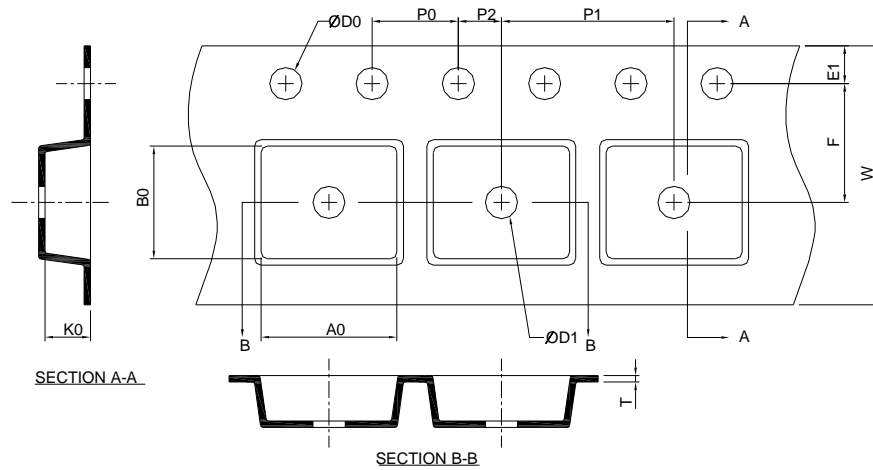

Application	A	H	T1	C	d	D	W	E1	F
WLCSP0.9X1.4	178.0±2.00	50 MIN.	8.4+2.00 -0.00	13.0+0.50 -0.20	1.5 MIN.	20.2 MIN.	8.0±0.30	1.75±0.10	3.5±0.05
	P0	P1	P2	D0	D1	T	A0	B0	K0
	4.0±0.10	4.0±0.10	2.0±0.05	1.5+0.10 -0.00	1.5 MIN.	0.6+0.00 -0.40	1.10±0.10	1.60±0.10	0.56±0.10

(mm)

Devices Per Unit

Package Type	Unit	Quantity
WLCSP0.9x1.4	Tape & Reel	3000

Taping Direction Information

WLCSP 0.9x1.4-6

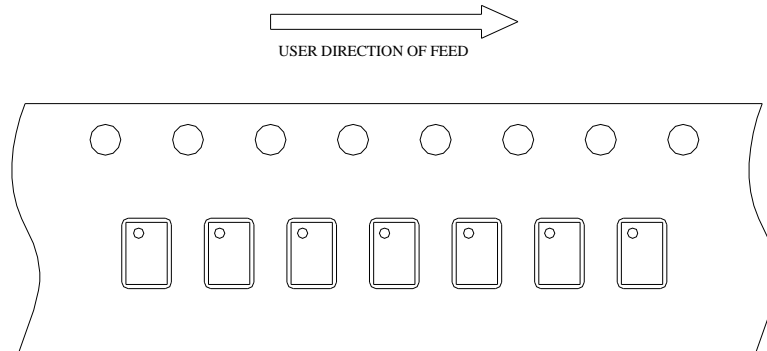

Classification Profile

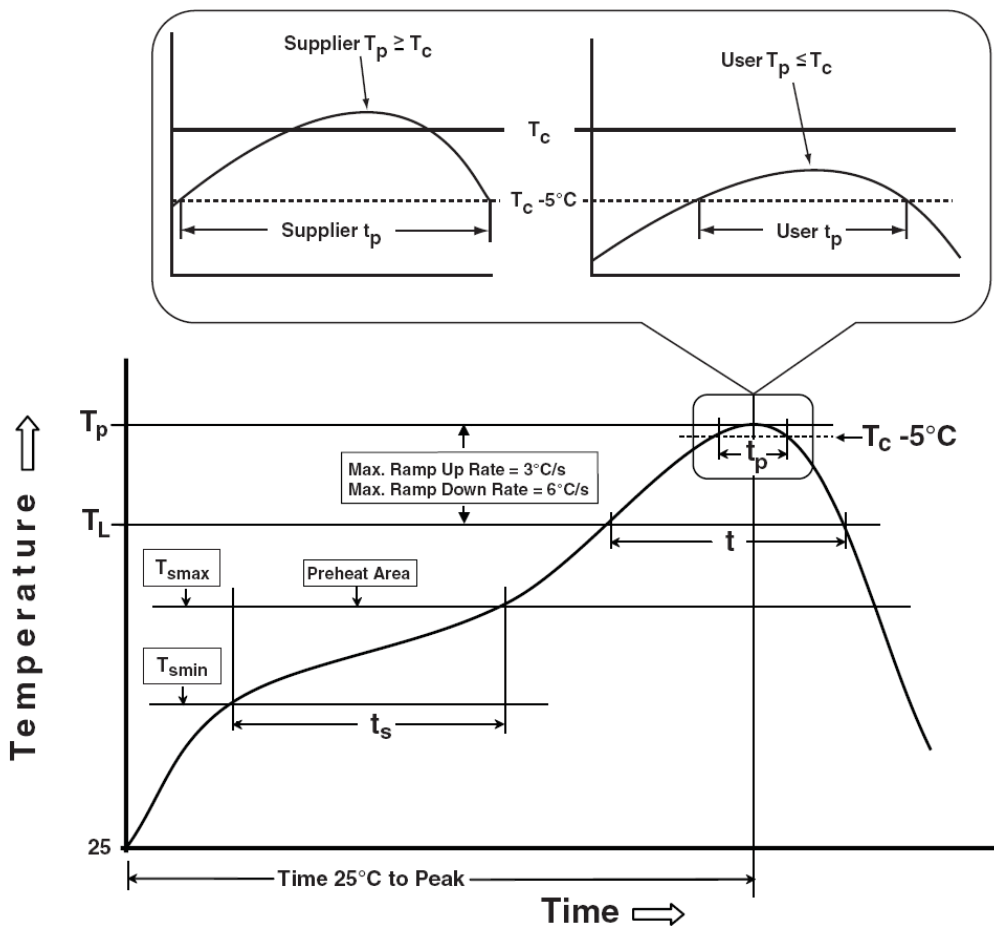

Classification Reflow Profiles

Profile Feature	Sn-Pb Eutectic Assembly	Pb-Free Assembly
Preheat & Soak Temperature min (T_{smin}) Temperature max (T_{smax}) Time (T_{smin} to T_{smax}) (t_s)	100 °C 150 °C 60-120 seconds	150 °C 200 °C 60-120 seconds
Average ramp-up rate (T_{smax} to T_p)	3 °C/second max.	3 °C/second max.
Liquidous temperature (T_L) Time at liquidous (t_L)	183 °C 60-150 seconds	217 °C 60-150 seconds
Peak package body Temperature (T_p)*	See Classification Temp in table 1	See Classification Temp in table 2
Time (t_p)** within 5°C of the specified classification temperature (T_c)	20** seconds	30** seconds
Average ramp-down rate (T_p to T_{smax})	6 °C/second max.	6 °C/second max.
Time 25°C to peak temperature	6 minutes max.	8 minutes max.
* Tolerance for peak profile Temperature (T_p) is defined as a supplier minimum and a user maximum. ** Tolerance for time at peak profile temperature (t_p) is defined as a supplier minimum and a user maximum.		

Table 1. SnPb Eutectic Process – Classification Temperatures (T_c)

Package Thickness	Volume mm ³ <350	Volume mm ³ ≥350
<2.5 mm	235 °C	220 °C
≥2.5 mm	220 °C	220 °C

Table 2. Pb-free Process – Classification Temperatures (T_c)

Package Thickness	Volume mm ³ <350	Volume mm ³ 350-2000	Volume mm ³ >2000
<1.6 mm	260 °C	260 °C	260 °C
1.6 mm – 2.5 mm	260 °C	250 °C	245 °C
≥2.5 mm	250 °C	245 °C	245 °C

Reliability Test Program

Test item	Method	Description
SOLDERABILITY	JESD-22, B102	5 Sec, 245°C
HOLT	JESD-22, A108	1000 Hrs, Bias @ $T_j=125^\circ\text{C}$
PCT	JESD-22, A102	168 Hrs, 100%RH, 2atm, 121°C
TCT	JESD-22, A104	500 Cycles, -65°C~150°C
HBM	MIL-STD-883-3015.7	VHBM ≥ 2KV
MM	JESD-22, A115	VMM ≥ 200V
Latch-Up	JESD 78	10ms, $I_{tr} \geq 100\text{mA}$

Customer Service

Anpec Electronics Corp.

Head Office :

No.6, Dusing 1st Road, SBIP,
Hsin-Chu, Taiwan, R.O.C.

Tel : 886-3-5642000

Fax : 886-3-5642050

Taipei Branch :

2F, No. 11, Lane 218, Sec 2 Jhongsing Rd.,
Sindian City, Taipei County 23146, Taiwan

Tel : 886-2-2910-3838

Fax : 886-2-2917-3838