

High Sensitivity Hall IC for FAN Driver

Features

- **On-Chip Hall Sensor**
- **Low Operating Supply Voltage: 2.5V**
- **Lower Speed Under 7.5V(Typ.) VDD Supply Voltage**
- **High Sensitivity Hall Effect Sensor IC: ±20G(Type.)**
- **Soft-Switch to Reduce Phase-Switching Noise**
- **Built-In Output Protection Clamping Circuit**
- **Lock Protection and Auto Restart Function**
- **Built-In Thermal Protection Circuit**
- **4 Pin TO92-M4 Package**
- **Lead Free and Green Devices Available (RoHS Compliant)**

Applications

- **Brushless DC Fans**
- **Brushless DC Motors**

General Description

The APX9149A is an integrated Hall Effect Sensor IC designed for electric commutation of two-phase DC brushless motor applications. In DC fan applications, the APX9149A provides lower driving current under 7.5V (typ.) VDD supply voltage for low noise applications. The device is built-in lock protection. When the fan is locked, the device will enter the lock protection mode. The APX9149A is available in a low cost TO-92M4 package.

Pin Description

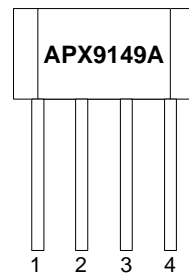

Front View

- 1 : VDD
- 2 : DO
- 3 : DOB
- 4 : GND

Ordering and Marking Information

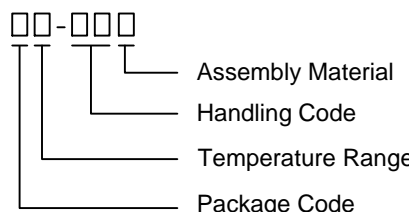
APX9149A		Package Code E : TO-92M4 Temperature Range I : -40 to 105 °C Handling Code PB : Plastic Bag Assembly Material G : Halogen and Lead Free Device
APX9149A E :	<div style="border: 1px solid black; padding: 2px; display: inline-block;"> APX 9149A XXXXX </div>	XXXXX - Date Code

Note: ANPEC lead-free products contain molding compounds/die attach materials and 100% matte tin plate termination finish; which are fully compliant with RoHS. ANPEC lead-free products meet or exceed the lead-free requirements of IPC/JEDEC J-STD-020D for MSL classification at lead-free peak reflow temperature. ANPEC defines "Green" to mean lead-free (RoHS compliant) and halogen free (Br or Cl does not exceed 900ppm by weight in homogeneous material and total of Br and Cl does not exceed 1500ppm by weight).

ANPEC reserves the right to make changes to improve reliability or manufacturability without notice, and advise customers to obtain the latest version of relevant information to verify before placing orders.

Absolute Maximum Ratings ($T_A=25^{\circ}\text{C}$ unless otherwise noted) (Note 1)

Symbol	Parameter	Rating	Unit
V_{DD}	VDD Pin Supply Voltage	-0.3 to 20	V
$V_{DO, DOB}$	Output Pin (DO, DOB) Output Voltage	-0.3 to $V_{OUT-CLAMP}$	V
I_{OUT}	Maximum Output Pin (DO, DOB) Sink Current – Continuous ^(Note 2) Hold Peak (<100 μs)	600 900 1200	mA
T_J	Maximum Junction Temperature	150	$^{\circ}\text{C}$
T_{STG}	Storage Temperature	-65 to 150	$^{\circ}\text{C}$
T_{SOR}	Maximum Lead Soldering Temperature, 10 Seconds	260	$^{\circ}\text{C}$

Note 1 : Absolute Maximum Ratings are those values beyond which the life of a device may be impaired. Exposure to absolute maximum rating conditions for extended periods may affect device reliability.

Note 2 : The maximum continuous current rating should refer recommend operating conditions (V_{DD} , T_A , T_J) to guarantee reliability.

Thermal Characteristics

Symbol	Parameter	Typical Value	Unit
θ_{JA}	Thermal Resistance-Junction to Ambient ^(Note 3) TO-92M4	131	$^{\circ}\text{C}/\text{W}$
P_D	Power Dissipation, $T_A = 25^{\circ}\text{C}$	950	mW

Note 3 : The maximum allowable power dissipation at any T_A (ambient temperature) is calculated using: $P_D(\text{max}) = (T_J - T_A) / \theta_{JA}$; $T_J = 150^{\circ}\text{C}$. Exceeding the maximum allowable power dissipation will result in excessive die temperature.

Recommended Operating Conditions

Symbol	Parameter	Range	Unit
V_{DD}	VDD Supply Voltage	2.5 to 16	V
T_A	Operating Ambient Temperature	-40 to 105	$^{\circ}\text{C}$
T_J	Junction Temperature	-40 to 125	$^{\circ}\text{C}$

Electrical Characteristics ($T_A=25^{\circ}\text{C}$, $V_{DD}=12\text{V}$ unless otherwise noted)

Symbol	Parameter	Test Conditions	APX9149A			Unit
			Min.	Typ.	Max.	
I_{DD1}	VDD Supply Current	$V_{DD}=2.5\text{V}$, Output Open	-	2	4	mA
I_{DD2}		$V_{DD}=20\text{V}$, Output Open	-	2	4	mA
V_{SAT1}	High Power Output Saturation Voltage	$V_{DD}=12\text{V}$, $I_{OUT}=300\text{mA}$	-	210	300	mV
V_{SAT2}	Low Power Output Saturation Voltage	$V_{DD}=4\text{V}$, $I_{OUT}=100\text{mA}$	1050	1250	1450	mV
V_{SAT3}	Start Up Output Saturation Voltage	$V_{DD}=2.5\text{V}$, $I_{OUT}=100\text{mA}$	-	100	200	mV
V_{TH1}	High Side VDD Threshold Voltage	V_{DD} falling	7	7.5	8	V
V_{hys}	V_{TH1} Hysteresis		-	-	0.5	V
V_{TH2}	Low Side VDD Threshold Voltage	V_{DD} rising	2.55	2.7	2.85	V
$V_{OUT-CLAMP}$	DO, DOB Output Clamp Voltage	DO, DOB Pin Off	20	24	28	V
I_{DOH}	DO Pin High Input Current	$V_{DO}=12\text{V}$, B<Brp	-	120	200	μA
I_{DOBH}	DOB Pin High Input Current	$V_{DOB}=12\text{V}$, B>Bop	-	120	200	μA

Electrical Characteristics (Cont.) ($T_A=25^{\circ}\text{C}$, $V_{DD}=12\text{V}$ unless otherwise noted)

Symbol	Parameter	Test Conditions	APX9149A			Unit
			Min.	Typ.	Max.	
T_{ON}	Lock Detection On Time		-	0.4	-	sec
T_{OFF}	Lock Detection Off Time		-	2.8	-	sec
T_{OTS}	Over Temperature Shutdown Threshold		-	165	-	$^{\circ}\text{C}$
	Over Temperature Shutdown Hysteresis		-	30	-	$^{\circ}\text{C}$

Magnetic Characteristics ($T_A=25^{\circ}\text{C}$, $V_{DD}=12\text{V}$ unless otherwise noted)

Symbol	Parameter	Test Conditions	APX9149A			Unit
			Min.	Typ.	Max.	
Bop	Magnetic Operation Point		5	20	40	Gauss
Brp	Magnetic Release Point		-40	-20	-5	Gauss
Bhys	Magnetic Hysteresis		30	40	50	Gauss

Typical Operating Characteristics

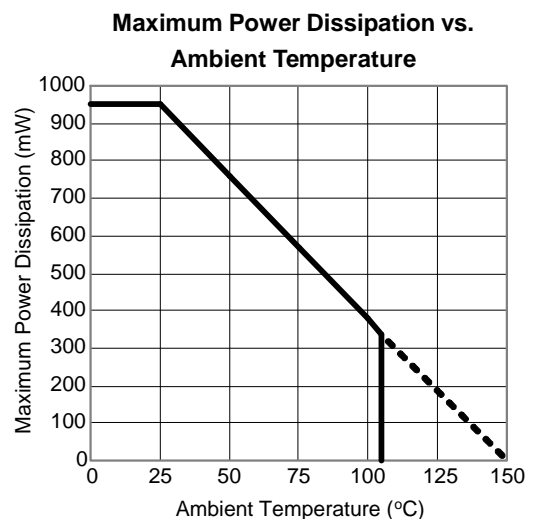
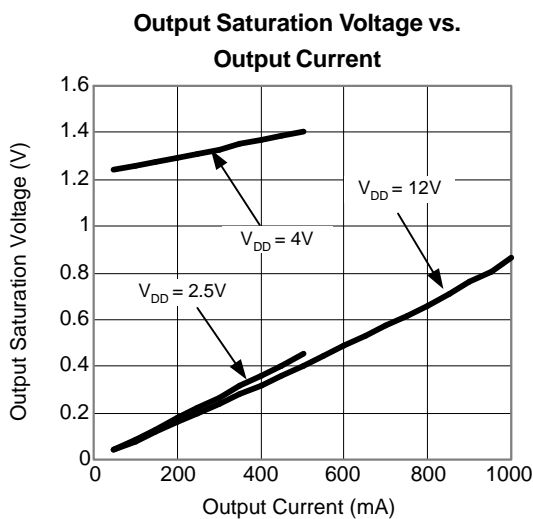
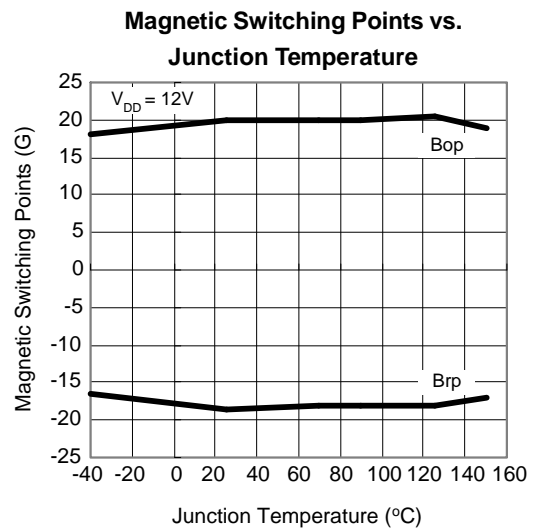
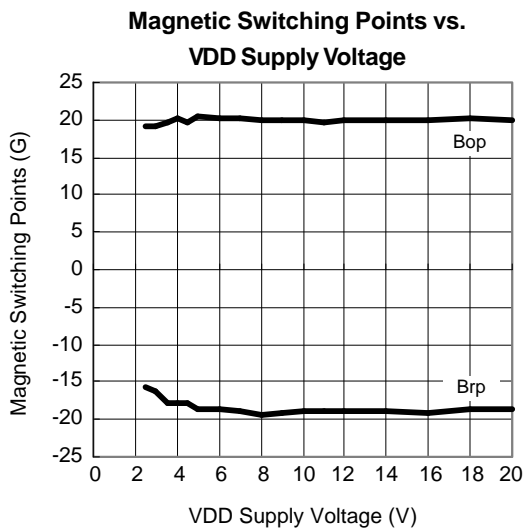
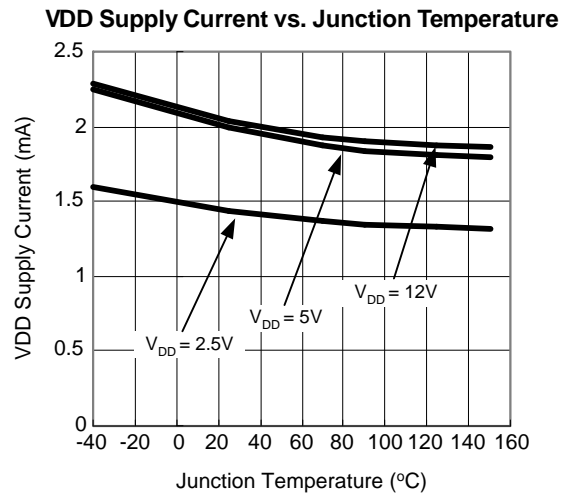
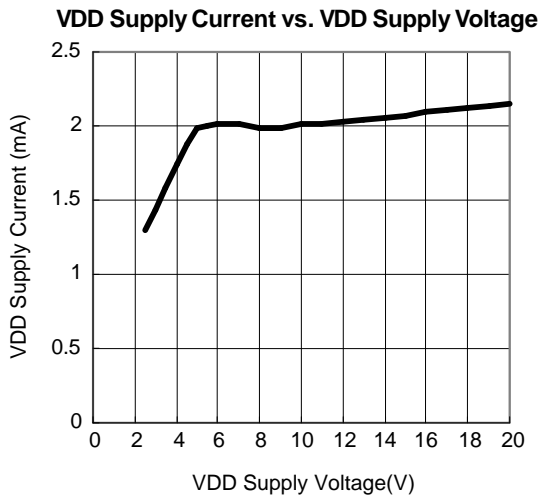

Operating Waveforms

Rotation Mode Waveform (VIN=14V)

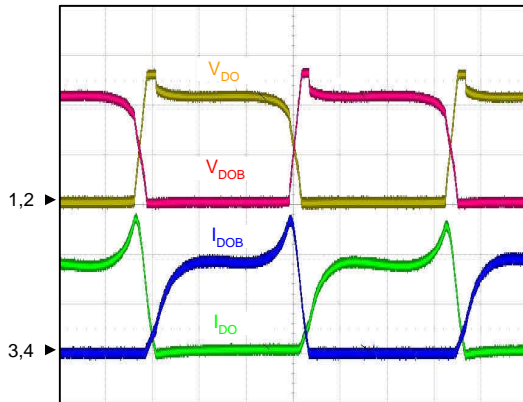

CH1: V_{DO} , 10V/div, DC
 CH2: V_{DOB} , 10V/div, DC
 CH3: I_{DOB} , 200mA/div, DC
 CH4: I_{DO} , 200mA/div, DC
 Time: 1ms/div

Lock Mode Waveform (VIN=14V)

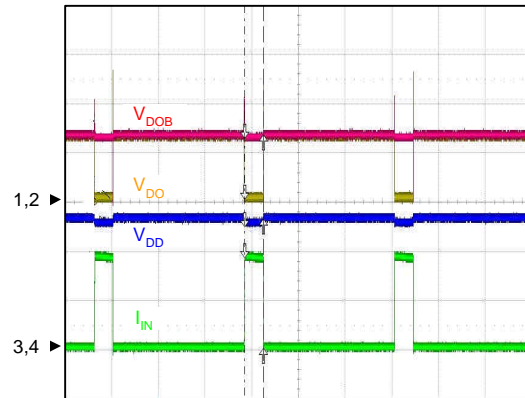

CH1: V_{DO} , 10V/div, DC
 CH2: V_{DOB} , 10V/div, DC
 CH3: V_{DD} , 5V/div, DC
 CH4: I_{IN} , 500mA/div, DC
 Time: 1s/div

Pin Description

PIN		FUNCTION
NO.	NAME	
1	VDD	Supply Voltage Input.
2	DO	Open Drain Output. Controlled by magnetic field input.
3	DOB	Open Drain Output. Controlled by magnetic field input.
4	GND	Ground of the IC.

Block Diagram

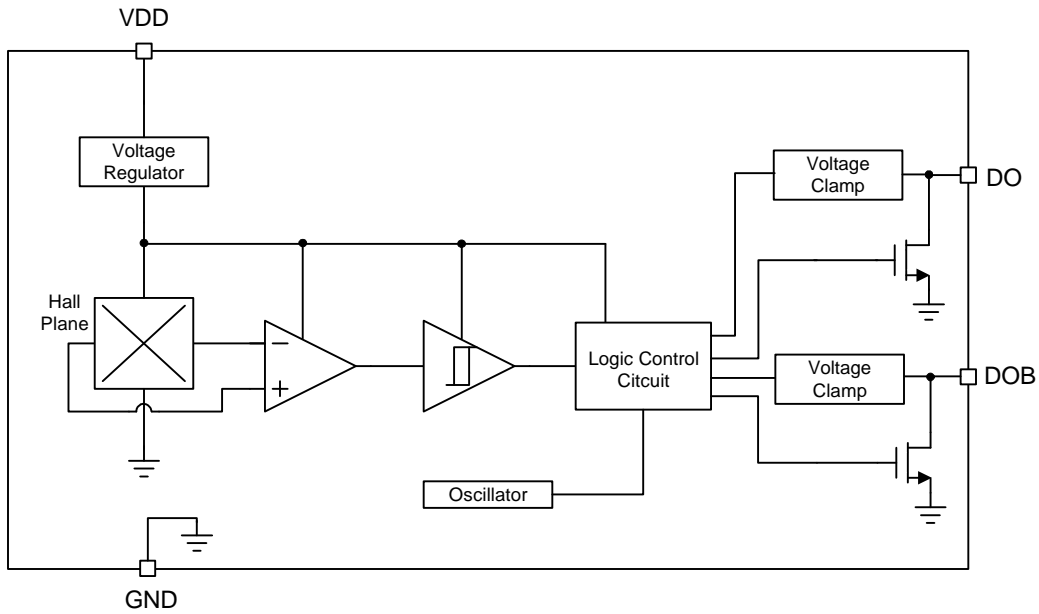

Typical Application Circuit

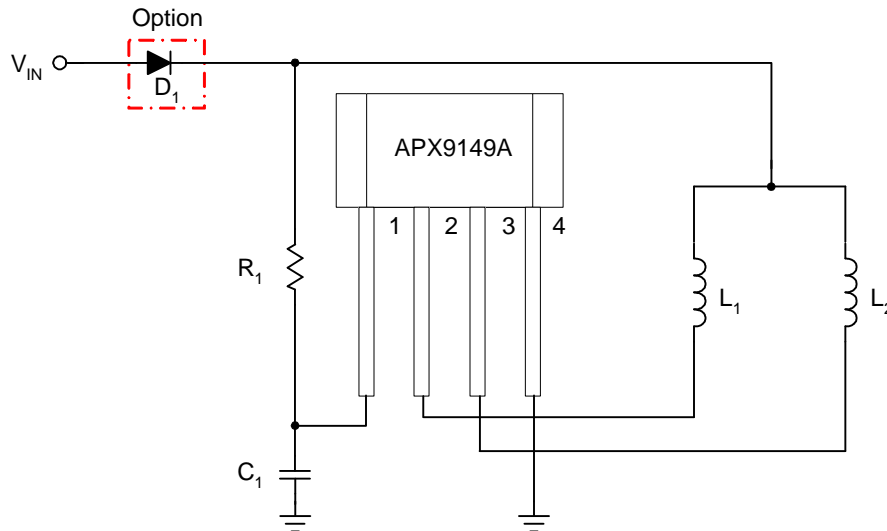

Notes: D_1 is to protect IC and coils when reverse power input.
 C_1 : typical $1\mu\text{F}/25\text{V}$ capacitor recommended.
 R_1 : typical 5.1Ω resistor recommended.
 The R_1 and C_1 are to avoid inrush current to damage IC at hot plug ON/OFF moments and the R_1 and C_1 values need to be selected base on coils design.

Function Description

Output Switch Principle

The APX9149A builds in a Hall-effect sensor plane to sense the vertical magnetic flux density (B). There are two output drivers in APX9149A to drive two-phase DC brushless motor. When the South pole magnetic field is close to the IC marking surface and the magnetic flux density higher than operate point (Bop), the DO pin output will turn ON and the DOB pin output will turn OFF. When the South pole magnetic field far away the IC marking surface and North pole magnetic field close to the IC marking surface until the magnetic flux density higher than release point (Brp), the DO pin output will turn OFF and the DOB pin output will turn ON.

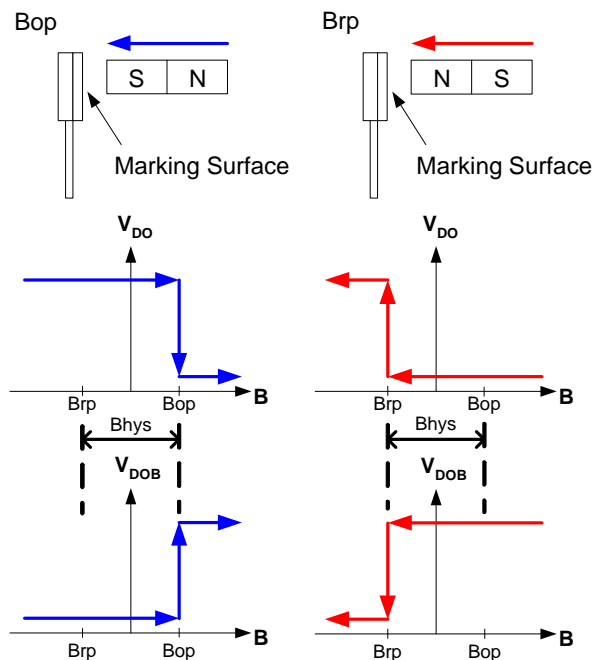

Lockup Protection and Automatic Restart

The APX9149A detects the rotation of the motor by internal hall sensor signal, and adjusts lock detection ON time (T_{ON}) and lock detection OFF time (T_{OFF}) by internal counter.

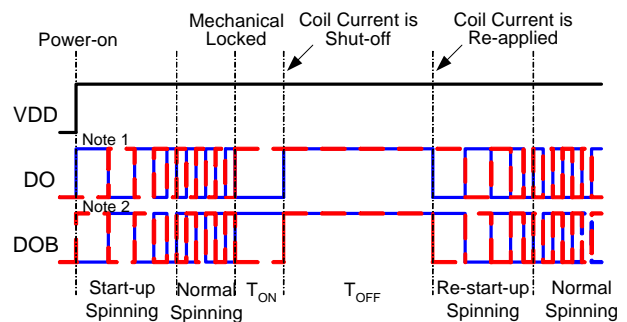

Note 1: — North pole face to the hall IC marking surface at power on.
 Note 2: — South pole face to the hall IC marking surface at power on.

Voltage Speed Control Function

In some DC fan applications, the system adjusts the input power voltage to control fan speed. The APX9149A internal circuit controls the lower fan speed in the low voltage region between V_{TH2} and V_{TH1} . When adjusts the VDD pin voltage from 12V to V_{TH1} (7.5V typical), the APX9149A will apply lower current to coils and the fan speed will be lower than original fan. A slower fan speed will have a smaller fan noise.

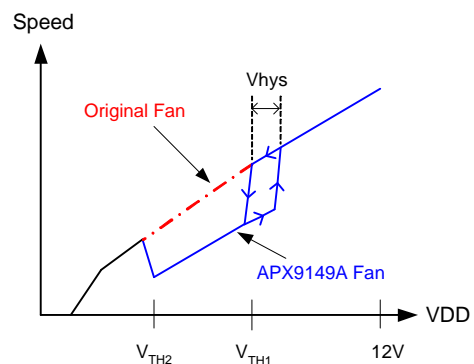

Thermal Protection

The APX9149A has a thermal protection. When the internal junction temperature reaches 165°C, the output devices will be switched off. When the IC's junction temperature cools by 30°C, the thermal sensor will turn the output devices on again, resulting in a pulsed output during continuous thermal protection.

Package Information

TO-92M4

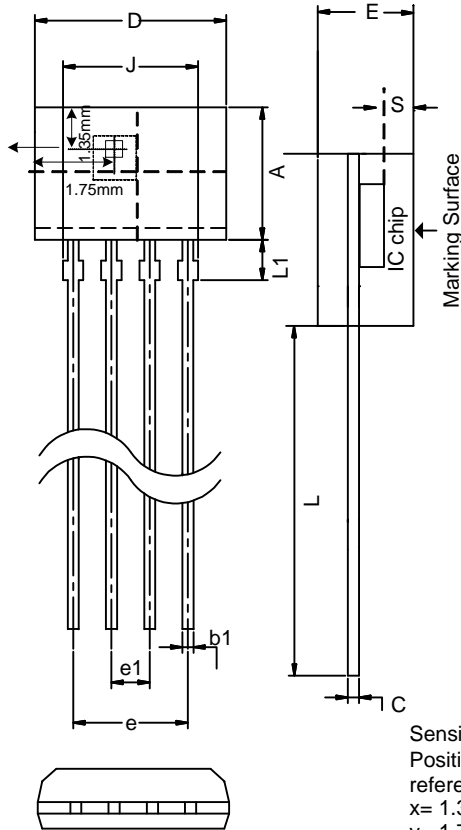

Sensitive Area (0.286x0.286mm²)
 Position of Hall Sensor
 reference to the top-left of package
 x= 1.35±0.1mm
 y= 1.75±0.1mm

SYMBOL	TO-92M4			
	MILLIMETERS		INCHES	
	MIN.	MAX.	MIN.	MAX.
A	3.60	3.70	0.142	0.146
b	0.35	0.41	0.014	0.016
c	0.35	0.41	0.014	0.016
D	5.17	5.27	0.204	0.208
e	1.27 BSC		0.050 BSC	
E	1.50	1.60	0.059	0.063
L	4.04	4.34	0.159	0.171
L2	1.34	1.54	0.053	0.061
s	0.70	0.76	0.028	0.030

Classification Profile

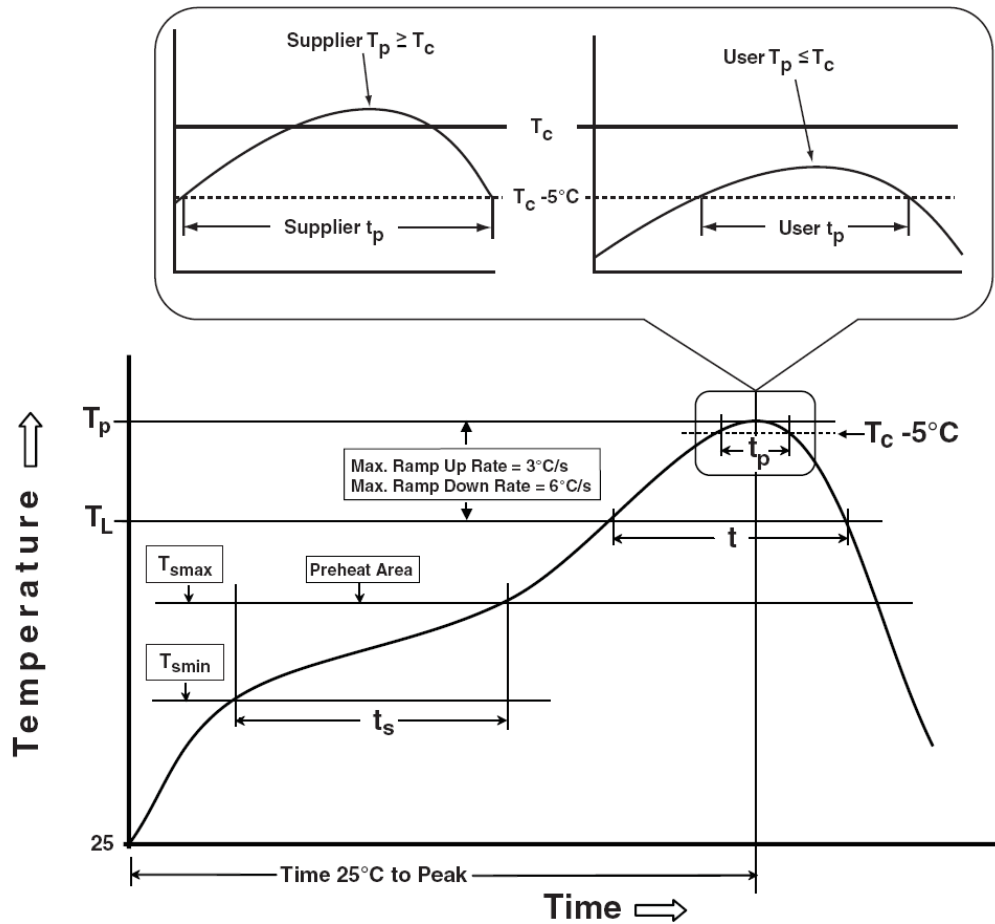

Classification Reflow Profiles

Profile Feature	Sn-Pb Eutectic Assembly	Pb-Free Assembly
Preheat & Soak		
Temperature min (T_{smin})	100 °C	150 °C
Temperature max (T_{smax})	150 °C	200 °C
Time (T_{smin} to T_{smax}) (t_s)	60-120 seconds	60-120 seconds
Average ramp-up rate (T_{smax} to T_p)	3 °C/second max.	3°C/second max.
Liquidous temperature (T_L)	183 °C	217 °C
Time at liquidous (t_L)	60-150 seconds	60-150 seconds
Peak package body Temperature (T_p)*	See Classification Temp in table 1	See Classification Temp in table 2
Time (t_p)** within 5°C of the specified classification temperature (T_c)	20** seconds	30** seconds
Average ramp-down rate (T_p to T_{smax})	6 °C/second max.	6 °C/second max.
Time 25°C to peak temperature	6 minutes max.	8 minutes max.
* Tolerance for peak profile Temperature (T_p) is defined as a supplier minimum and a user maximum.		
** Tolerance for time at peak profile temperature (t_p) is defined as a supplier minimum and a user maximum.		

Classification Reflow Profiles (Cont.)

Table 1. SnPb Eutectic Process – Classification Temperatures (Tc)

Package Thickness	Volume mm ³ <350	Volume mm ³ ≥350
<2.5 mm	235 °C	220 °C
≥2.5 mm	220 °C	220 °C

Table 2. Pb-free Process – Classification Temperatures (Tc)

Package Thickness	Volume mm ³ <350	Volume mm ³ 350-2000	Volume mm ³ >2000
<1.6 mm	260 °C	260 °C	260 °C
1.6 mm – 2.5 mm	260 °C	250 °C	245 °C
≥2.5 mm	250 °C	245 °C	245 °C

Reliability Test Program

Test item	Method	Description
SOLDERABILITY	JESD-22, B102	5 Sec, 245°C
HOLT	JESD-22, A108	1000 Hrs, Bias @ T _j =125°C
PCT	JESD-22, A102	168 Hrs, 100%RH, 2atm, 121°C
TCT	JESD-22, A104	500 Cycles, -65°C~150°C
HBM	MIL-STD-883-3015.7	VHBM 2KV
MM	JESD-22, A115	VMM 200V
Latch-Up	JESD 78	10ms, 1 _{tr} 100mA

Customer Service

Anpec Electronics Corp.

Head Office :

No.6, Dusing 1st Road, SBIP,
Hsin-Chu, Taiwan
Tel : 886-3-5642000
Fax : 886-3-5642050

Taipei Branch :

2F, No. 11, Lane 218, Sec 2 Jhongsing Rd.,
Sindian City, Taipei County 23146, Taiwan
Tel : 886-2-2910-3838
Fax : 886-2-2917-3838