

Features

- 500V, 13A
- $R_{DS(ON)} = 0.6\Omega$ (Max.) @ $V_{GS} = 10V, I_D = 6.5A$
- Fast switching
- 100% avalanche tested
- Improved dv/dt capability
- RoHS and Halogen-Free Compliant

Application

- Switch Mode Power Supply (SMPS)
- Uninterruptible Power Supply (UPS)
- Power Factor Correction (PFC)

Package

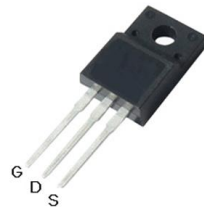

TO-220F
WFF13N50MA

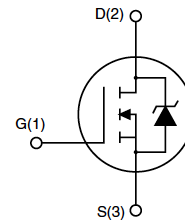

Absolute Maximum Ratings $T_C=25^\circ C$ unless otherwise specified

Symbol	Parameter	Max.	Units
V_{DSS}	Drain-Source Voltage	500	V
V_{GSS}	Gate-Source Voltage	± 30	V
I_D	Continuous Drain Current ^{note5}	13	A
	$T_C = 25^\circ C$		
I_{DM}	Pulsed Drain Current ^{note3}	52	A
P_D	Power Dissipation ^{note2}	39.5	W
	$T_C = 25^\circ C$		
E_{AS}	Single Pulse Avalanche Energy ^{note3,6}	810	mJ
$R_{\theta JC}$	Thermal Resistance, Junction to Case	3	$^\circ C/W$
$R_{\theta JA}$	Thermal Resistance, Junction to Ambient ^{note1,4}	62.5	$^\circ C/W$
T_J, T_{STG}	Operating and Storage Temperature Range	-55 to +150	$^\circ C$

Electrical Characteristics $T_C=25^\circ\text{C}$ unless otherwise specified

Symbol	Parameter	Test Condition	Min.	Typ.	Max.	Units
Off Characteristic						
BV_{DSS}	Drain-Source Breakdown Voltage	$V_{GS} = 0V, I_D = 250\mu A$	500	-	-	V
I_{DSS}	Drain-Source Leakage Current	$V_{DS} = 500V, V_{GS} = 0V$	-	-	1	μA
I_{GSS}	Gate to Body Leakage Current	$V_{DS} = 0V, V_{GS} = \pm 30V$	-	-	± 100	nA
On Characteristics						
$V_{GS(th)}$	Gate Threshold Voltage	$V_{DS} = V_{GS}, I_D = 250\mu A$	2	-	4	V
$R_{DS(on)}$	Static Drain-Source On-Resistance	$V_{GS} = 10V, I_D = 6.5A$	-	0.45	0.6	Ω
Dynamic Characteristics						
C_{iss}	Input Capacitance	$V_{DS} = 25V, V_{GS} = 0V,$ $f = 1.0MHz$	-	1610	-	pF
C_{oss}	Output Capacitance		-	172	-	pF
C_{rss}	Reverse Transfer Capacitance		-	13.8	-	pF
Switching Characteristics						
Q_g	Total Gate Charge	$V_{DS} = 400V, I_D = 13A,$ $V_{GS} = 10V$	-	40	-	nC
Q_{gs}	Gate-Source Charge		-	8	-	
Q_{gd}	Gate-Drain("Miller") Charge		-	16	-	
$t_{d(on)}$	Turn-On Delay Time	$V_{DS} = 250V, I_D = 13A,$ $R_G = 25\Omega, V_{GS} = 10V$	-	23	-	ns
t_r	Turn-On Rise Time		-	44	-	
$t_{d(off)}$	Turn-Off Delay Time		-	110	-	
t_f	Turn-Off Fall Time		-	55	-	
Diode Characteristics						
V_{SD}	Diode Forward Voltage ^{note3}	$I_S = 6.5A, V_{GS} = 0V$	-	-	1.4	V
t_{rr}	Reverse Recovery Time	$I_{SD} = 13A, V_{GS} = 0V$	-	360	-	ns
Q_{rr}	Reverse Recovery Charge	$di_{SD}/dt = 100A/\mu s$	-	3.3	-	nC

Notes:

- The value of $R_{\theta JC}$ is measured in a still air environment with $T_A = 25^\circ\text{C}$ and the maximum allowed junction temperature of 150°C . The value in any given application depends on the user's specific board design.
- The power dissipation P_D is based on $T_{J(MAX)} = 150^\circ\text{C}$, using junction-to-case thermal resistance, and is more useful in setting the upper dissipation limit for cases where additional heatsinking is used.
- Single pulse width limited by junction temperature $T_{J(MAX)} = 150^\circ\text{C}$.
- The $R_{\theta JA}$ is the sum of the thermal impedance from junction to case $R_{\theta JC}$ and case to ambient.
- The maximum current rating is package limited.
- The EAS data shows Max. rating. The test condition is $V_{DS} = 100V, V_{GS} = 10V, L = 10mH$

Typical Performance Characteristics

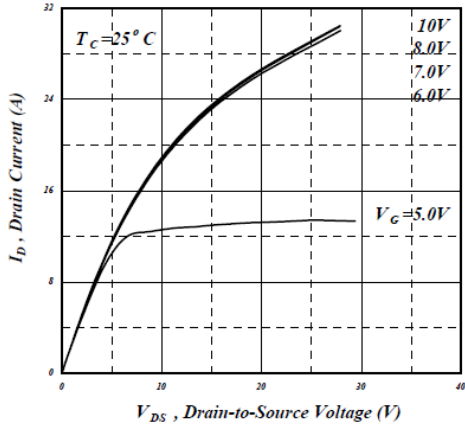

Figure 1. Output Characteristics

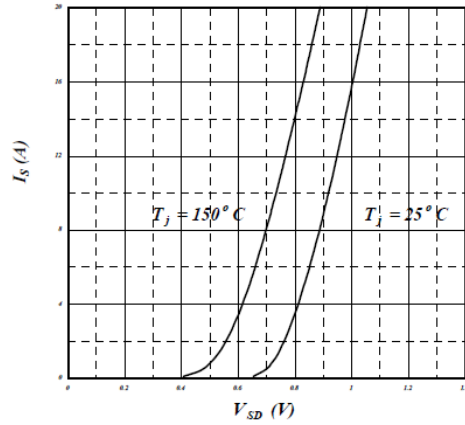

Figure 2. Body Diode Forward Voltage vs Source Current and Temperature

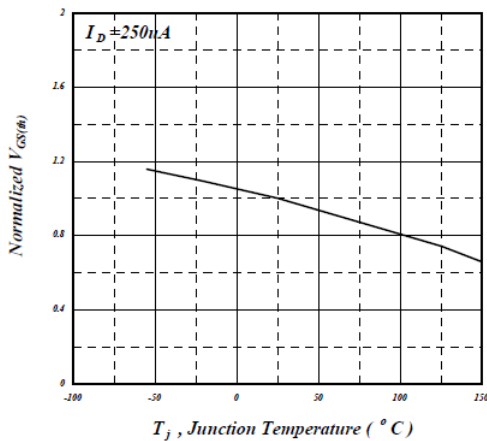

Figure 3. Normalized On Resistance vs Junction Temperature

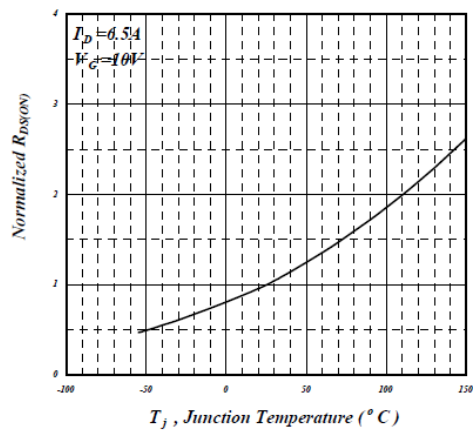

Figure 4. Normalized On Resistance vs Junction Temperature

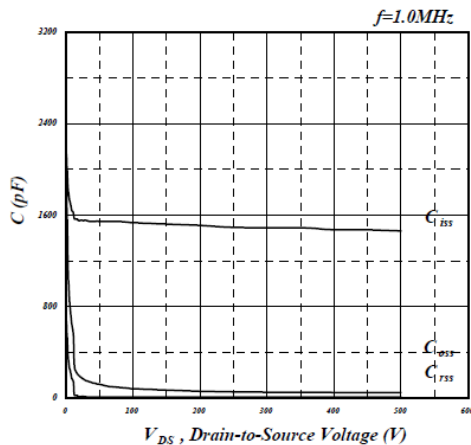

Figure 5. Capacitance Characteristics

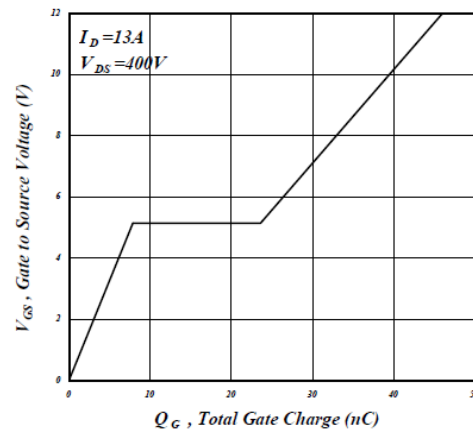

Figure 6. Gate Charge Characteristics

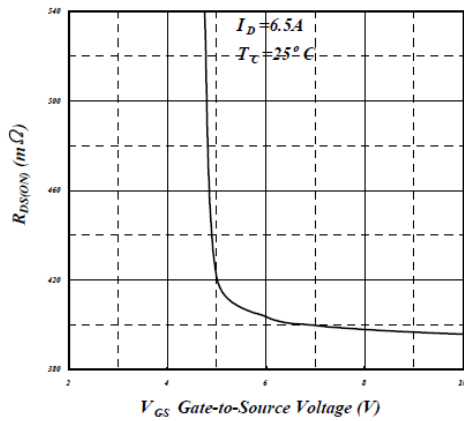

Figure 7. Normalized Breakdown Voltage vs Junction Temperature

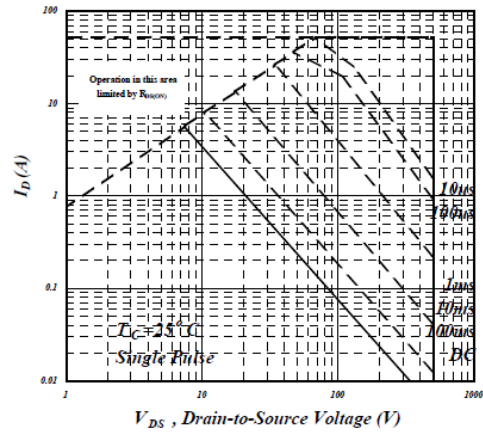

Figure 8. Maximum Safe Operating Area

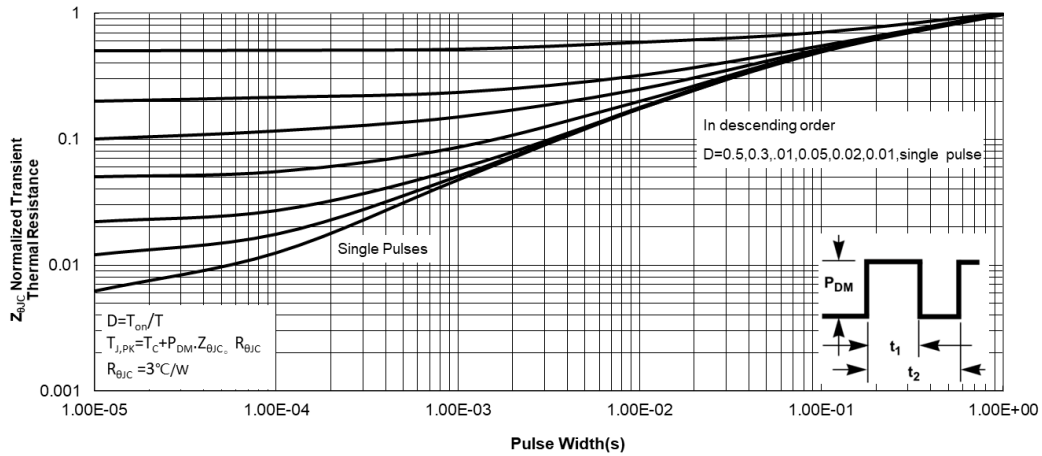
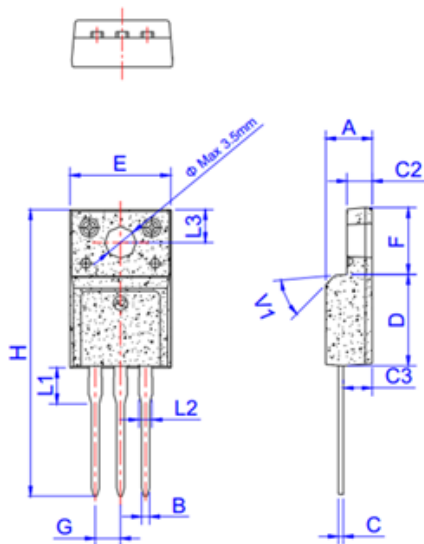

Figure 9. Maximum Effective Transient Thermal Impedance, Junction-to-Case

TO-220F-3L Package Mechanical Data



Ref.	Dimensions					
	Millimeters			Inches		
	Min.	Typ.	Max.	Min.	Typ.	Max.
A	4.50		4.90	0.177		0.193
B	0.74	0.80	0.83	0.029	0.031	0.033
C	0.47		0.65	0.019		0.026
C2	2.45		2.75	0.096		0.108
C3	2.60		3.00	0.102		0.118
D	8.80		9.30	0.346		0.366
E	9.80		10.4	0.386		0.410
F	6.40		6.80	0.252		0.268
G		2.54			0.1	
H	28.0		29.8	1.102		1.173
L1		3.63			0.143	
L2	1.14		1.70	0.045		0.067
L3		3.30			0.130	
V1		45°			45°	

WFF13N50MA Product Description

Silicon N-Channel MOSFET



NOTE:

1. We strongly recommend customers check carefully on the trademark when buying our product, if there is any question, please don't be hesitate to contact us.
2. Please do not exceed the absolute maximum ratings of the device when circuit designing.
3. Winsemi Microelectronics Co., Ltd reserved the right to make changes in this specification sheet and is subject to change without prior notice.

CONTACT:

WINSEMI Microelectronics Co., Ltd.

ADD: Room 1002, East, Phase 2, HighTech Plaza, Tian-An Cyber Park, Che gong miao, FuTian, Shenzhen, P.R. China.

Post Code : 518040

Tel : +86-755-8250 6288

FAX : +86-755-8250 6299

Web Site : www.winsemi.com