

1.1MHz, Precision, Rail-to-Rail I/O CMOS Operational Amplifier

FEATURES

- **HIGH GAIN BANDWIDTH: 1.1MHz**
- **RAIL-TO-RAIL INPUT AND OUTPUT**
 $\pm 0.5\text{mV Max Vos (RS6331P, RS6332P)}$
 $\pm 0.8\text{mV Max Vos (RS6334P)}$
- **INPUT VOLTAGE RANGE: -0.1V to +5.6V**
with $V_s = 5.5\text{V}$
- **SUPPLY RANGE: +2.1V to +5.5V**
- **SPECIFIED UP TO +125°C**
- **Micro SIZE PACKAGES: SOT23-5,**
SOT353(SC70-5)

APPLICATIONS

- **SENSORS**
- **PHOTODIODE AMPLIFICATION**
- **ACTIVE FILTERS**
- **TEST EQUIPMENT**
- **DRIVING A/D CONVERTERS**

DESCRIPTION

The RS6331P, RS6332P, RS6334P families of products offer low voltage operation and rail-to-rail input and output, as well as excellent speed/power consumption ratio, providing an excellent bandwidth (1.1MHz) and slew rate of 0.5V/us. The op-amps are unity gain stable and feature an ultra-low input bias current.

The RS6331P, RS6332P and RS6334P has lower offset, which is guaranteed not upper than $\pm 0.5\text{mV}$ (RS6331P, RS6332P) / $\pm 0.8\text{mV}$ (RS6334P) at 25°C with $V_s = 5\text{V}$, $V_{CM} = V_s/2$.

The devices are ideal for sensor interfaces, active filters and portable applications. The RS6331P, RS6332P, RS6334P families of operational amplifiers are specified at the full temperature range of -40°C to +125°C under single supplies of 2.1V to 5.5V or dual power supplies of $\pm 1.05\text{V}$ to $\pm 2.75\text{V}$.

PIN CONFIGURATIONS

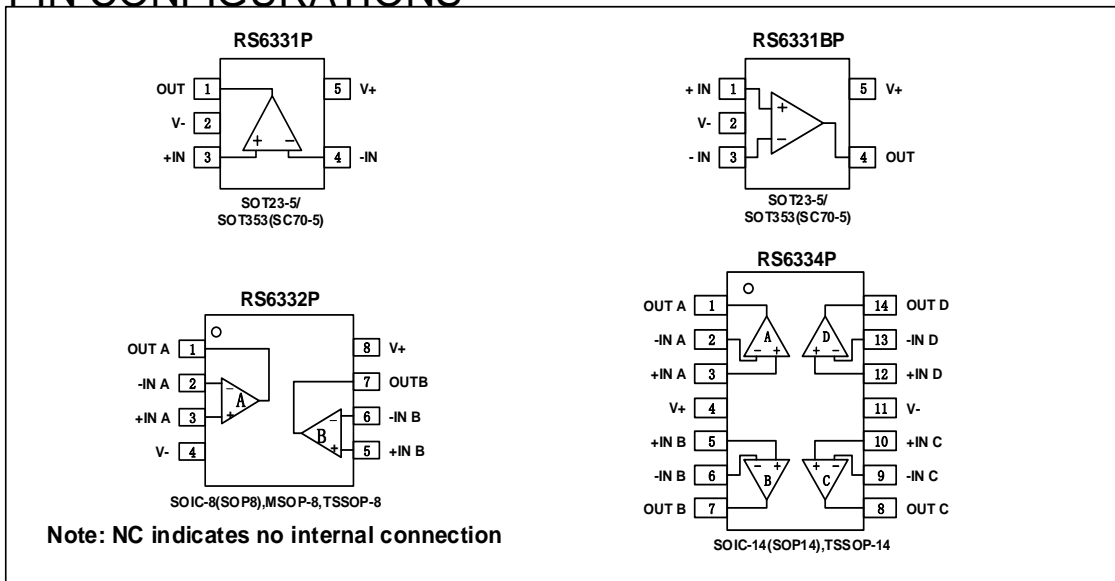

ABSOLUTE MAXIMUM RATINGS (1)

Supply Voltage, V+ to V-.....	7.0V
Input Terminals, Voltage (2)	- 0.5 to (V+) + 0.5V
Current (2)	±10mA
Storage Temperature	-65°C to +150°C
Operating Temperature	-40°C to +125°C
Junction Temperature.....	150°C
Package Thermal Resistance @ TA = +25°C	
SOT23-5, SOT23-6.....	200°C/W
SOT353(SC70-5)	250°C/W
MSOP-8, SOIC-8, TSSOP-8.....	150°C/W
SOIC-14, TSSOP-14.....	100°C/W
Lead Temperature (Soldering, 10s)	260°C
ESD Susceptibility	
HBM	3000V
MM	200V

(1) Stresses above these ratings may cause permanent damage. Exposure to absolute maximum conditions for extended periods may degrade device reliability. These are stress ratings only, and functional operation of the device at these or any other conditions beyond those specified is not implied.

(2) Input terminals are diode-clamped to the power-supply rails. Input signals that can swing more than 0.5V beyond the supply rails should be current-limited to 10mA or less.

ESD SENSITIVITY CAUTION

ESD damage can range from subtle performance degradation to complete device failure. Precision integrated circuits may be more susceptible to damage because very small parametric changes could cause the device not to meet its published specifications.

PACKAGE/ORDERING INFORMATION

PRODUCT	ORDERING NUMBER	TEMPERATURE RANGE	PACKAGE LEAD	PACKAGE MARKING	PACKAGE OPTION
RS6331P	RS6331PXF	-40°C~125°C	SOT23-5	6331P	Tape and Reel,3000
	RS6331BPXF	-40°C~125°C	SOT23-5	6331BP	Tape and Reel,3000
	RS6331PXC5	-40°C~125°C	SOT353(SC70-5)	6331P	Tape and Reel,3000
	RS6331BPXC5	-40°C~125°C	SOT353(SC70-5)	6331BP	Tape and Reel,3000
RS6332P	RS6332PXK	-40°C~125°C	SOIC-8(SOP8)	RS6332P	Tape and Reel,2500
	RS6332PXM	-40°C~125°C	MSOP-8	RS6332P	Tape and Reel,3000
	RS6332PXQ	-40°C~125°C	TSSOP-8	RS6332P	Tape and Reel,3000
RS6334P	RS6334PXP	-40°C~125°C	SOIC-14(SOP14)	RS6334P	Tape and Reel,2500
	RS6334PXQ	-40°C~125°C	TSSOP-14	RS6334P	Tape and Reel,3000

ELECTRICAL CHARACTERISTICS

 (At $T_A = +25^\circ\text{C}$, $V_S = 5\text{V}$, $R_L = 10\text{k}\Omega$ connected to $V_S/2$, and $V_{OUT} = V_S/2$, unless otherwise noted.)

PARAMETER		CONDITIONS	T_J	RS6331P, RS6332P, RS6334P			UNITS	
				MIN	TYP	MAX		
POWER SUPPLY								
V_S	Operating Voltage Range		25°C	2.1		5.5	V	
I_Q	Quiescent Current/Amplifier		25°C		85	145	μA	
PSRR	Power-Supply Rejection Ratio	$V_S = 2.1\text{V to } 5.5\text{V}$, $V_{cm} = (V_-) + 0.5\text{V}$	25°C	75	92		dB	
			$-40^\circ\text{C to } 125^\circ\text{C}$	65				
INPUT								
V_{os}	Input Offset Voltage	RS6331P	25°C		± 0.2	± 0.5	mV	
		RS6332P	25°C		± 0.2	± 0.5		
		RS6334P	25°C		± 0.3	± 0.8		
$V_{os\ TC}$	Input Offset Voltage Average Drift	$-40^\circ\text{C to } 125^\circ\text{C}$			2		$\mu\text{V}/^\circ\text{C}$	
I_B	Input Bias Current		25°C		10	50	pA	
I_{os}	Input Offset Current		25°C		10	50	pA	
V_{cm}	Common-Mode Voltage Range	$V_S = 5.5\text{V}$	25°C	-0.1		5.6	V	
CMRR	Common-Mode Rejection Ratio	$V_S = 5.5\text{V}$, $V_{cm} = -0.1\text{V to } 4\text{V}$	25°C	75	95		dB	
			$-40^\circ\text{C to } 125^\circ\text{C}$	68				
			25°C	63	85			
			$-40^\circ\text{C to } 125^\circ\text{C}$	57				
OUTPUT								
AOL	Open-Loop Voltage Gain	$R_L = 2\text{k}\Omega$, $V_o = 0.15\text{V to } 4.85\text{V}$	25°C	95	110		dB	
			$-40^\circ\text{C to } 125^\circ\text{C}$	85				
			$R_L = 10\text{k}\Omega$, $V_o = 0.05\text{V to } 4.95\text{V}$	25°C	100	120		
				$-40^\circ\text{C to } 125^\circ\text{C}$	92			
	Output Swing From Rail	$R_L = 2\text{k}\Omega$ $R_L = 10\text{k}\Omega$	25°C		25		mV	
					8			
I_{out}	Output Current Source		25°C		120		mA	
FREQUENCY RESPONSE								
SR	Slew Rate		25°C		0.5		$\text{V}/\mu\text{s}$	
GBP	Gain-Bandwidth Product		25°C		1.1		MHz	
PM	Phase Margin		25°C		64		$^\circ$	
t_s	Setting Time, 0.1%				1.3		μs	
	Overload Recovery Time	$V_{IN} \cdot \text{Gain} \geq V_S$			4.7		μs	
	Turn-on time	$V_S = 5\text{V}$			20		μs	
NOISE								
e_n	Input Voltage Noise Density	$f = 1\text{KHz}$	25°C		22		$\text{nV}/\sqrt{\text{Hz}}$	
		$f = 10\text{KHz}$	25°C		20		$\text{nV}/\sqrt{\text{Hz}}$	

TYPICAL CHARACTERISTICS

At $T_A = +25^\circ\text{C}$, $V_S = 5\text{V}$, $R_L = 10\text{k}\Omega$ connected to $V_S/2$, $V_{OUT} = V_S/2$, unless otherwise noted.

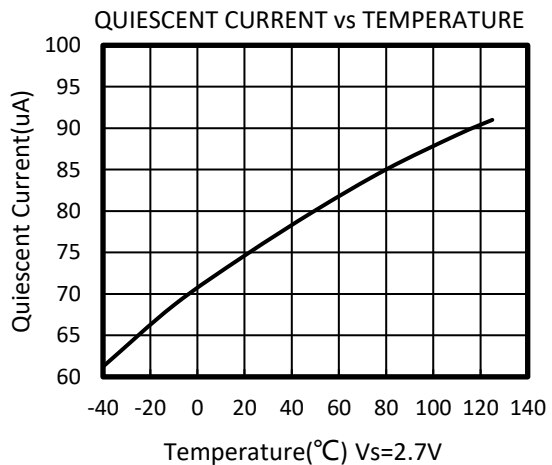
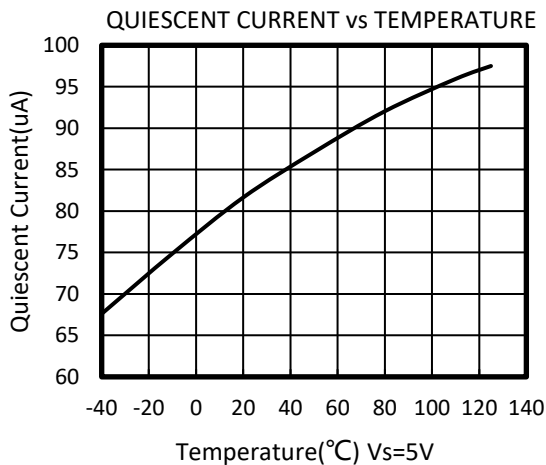
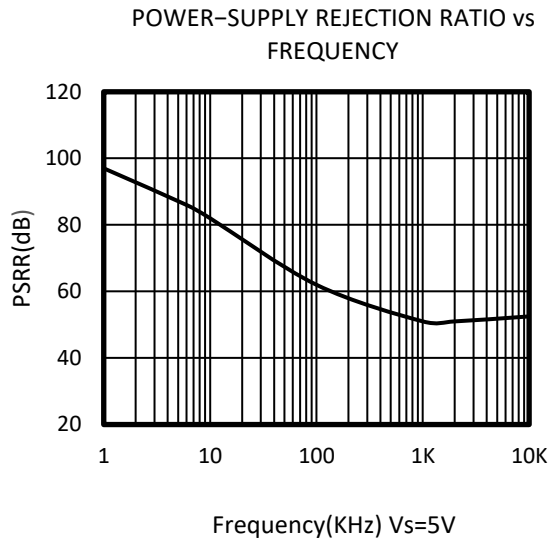
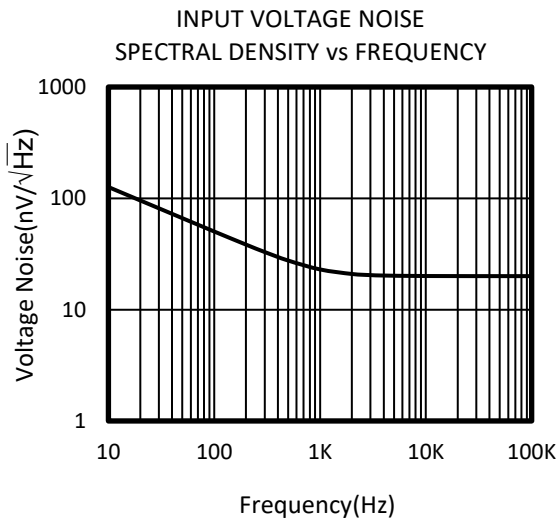
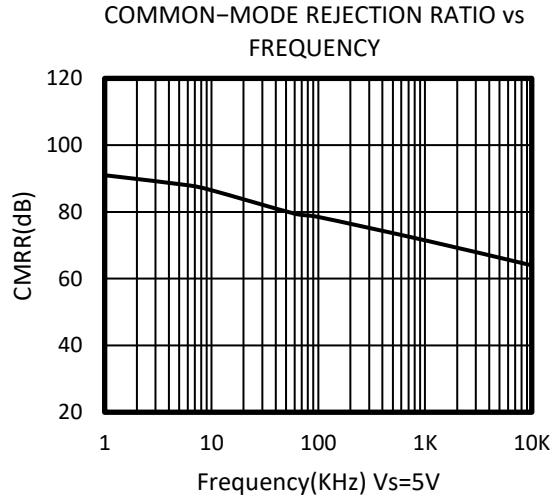
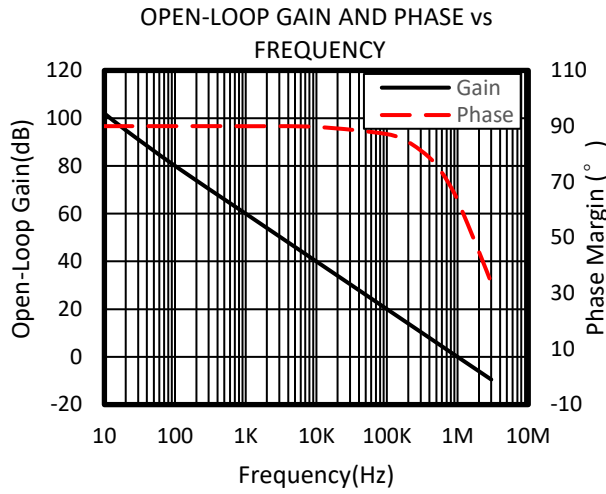

TYPICAL CHARACTERISTICS

At $T_A = +25^\circ\text{C}$, $V_S = 5\text{V}$, $R_L = 10\text{k}\Omega$ connected to $V_S/2$, $V_{OUT} = V_S/2$, unless otherwise noted.

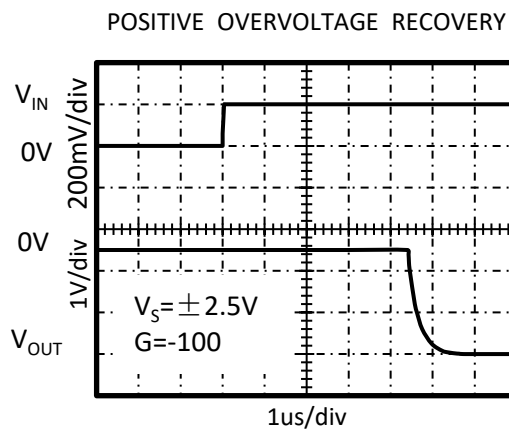
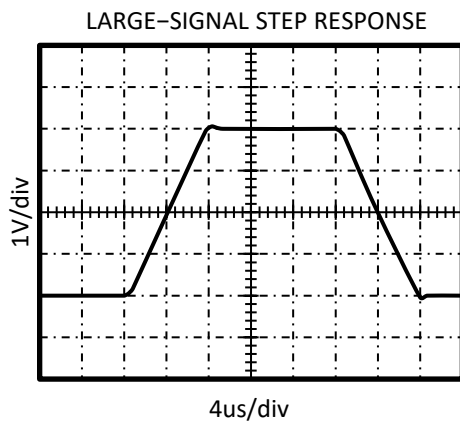
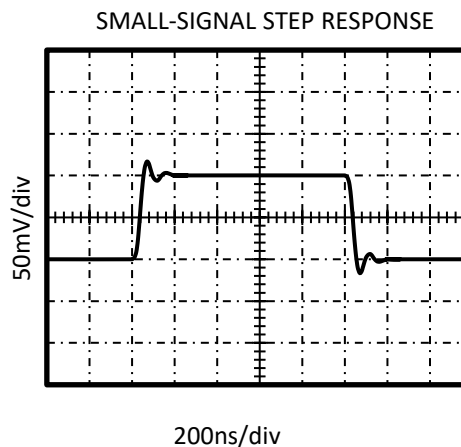
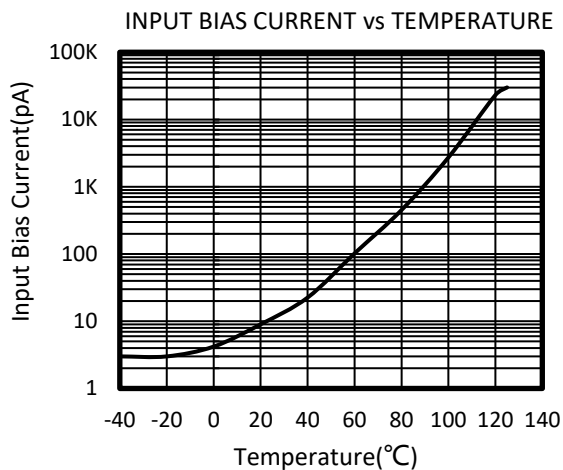
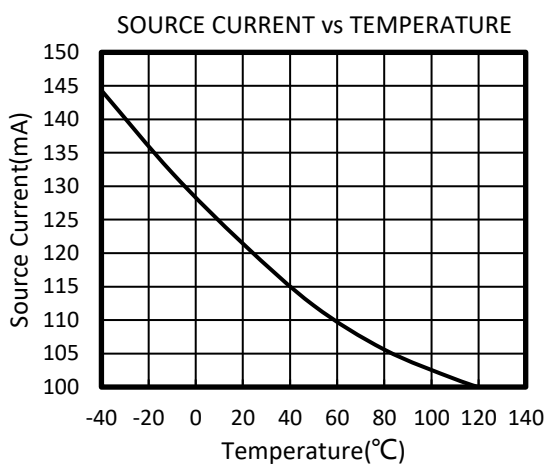
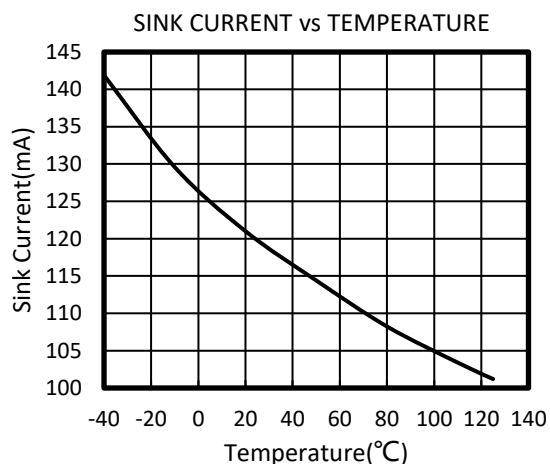

TYPICAL CHARACTERISTICS

At $T_A = +25^\circ\text{C}$, $V_S = 5\text{V}$, $R_L = 10\text{k}\Omega$ connected to $V_S/2$, $V_{OUT} = V_S/2$, unless otherwise noted.

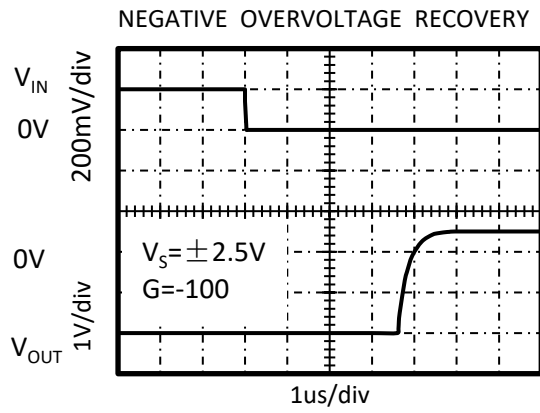

APPLICATION NOTES

The RS6331P, RS6332P, RS6334P, are high precision, rail-to-rail operational amplifiers that can be run from a single-supply voltage 2.1V to 5.5V ($\pm 1.05V$ to $\pm 2.75V$). Supply voltages higher than 7V (absolute maximum) can permanently damage the amplifier.

Rail-to-rail input and output swing significantly increases dynamic range, especially in low-supply applications.

Good layout practice mandates use of a 0.1uF capacitor place closely across the supply pins.

LAYOUT GUIDELINS

Attention to good layout practices is always recommended. Keep traces short. When possible, use a PCB ground plane with surface-mount components placed as close to the device pins as possible. Place a 0.1uF capacitor closely across the supply pins.

These guidelines should be applied throughout the analog circuit to improve performance and provide benefits such as reducing the EMI susceptibility.

INSTRUMENTATION AMPLIFIER

In the three-op amp, instrumentation amplifier configuration shown in Figure2,

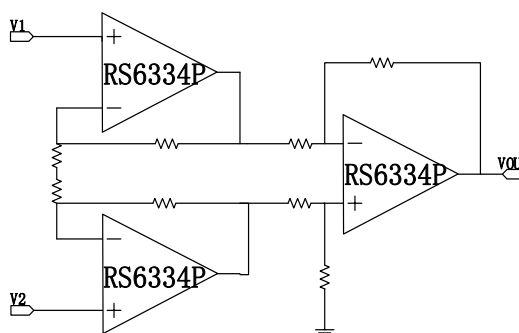

Figure2. Amplifier instrumentation amplifier

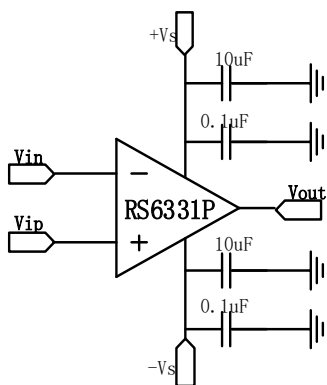
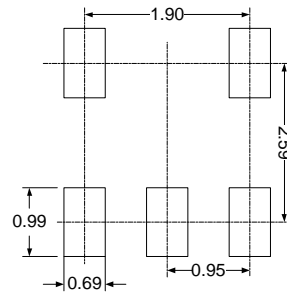
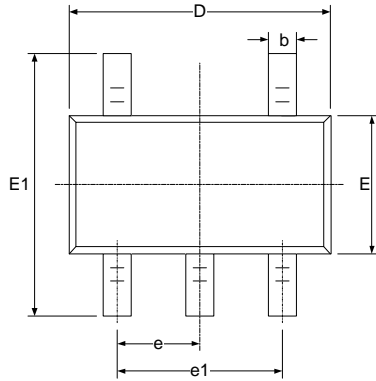

Figure1. Amplifier with Bypass Capacitors

PACKAGE OUTLINE DIMENSIONS

SOT23-5



RECOMMENDED LAND PATTERN (Unit: mm)

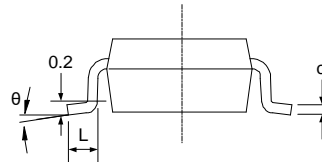
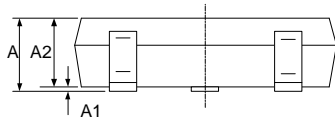

Symbol	Dimensions In Millimeters		Dimensions In Inches	
	Min	Max	Min	Max
A	1.050	1.250	0.041	0.049
A1	0.000	0.100	0.000	0.004
A2	1.050	1.150	0.041	0.045
b	0.300	0.500	0.012	0.020
c	0.100	0.200	0.004	0.008
D	2.820	3.020	0.111	0.119
E	1.500	1.700	0.059	0.067
E1	2.650	2.950	0.104	0.116
e	0.950(BSC)		0.037(BSC)	
e1	1.800	2.000	0.071	0.079
L	0.300	0.600	0.012	0.024
θ	0°	8°	0°	8°

SOT353(SC70-5)

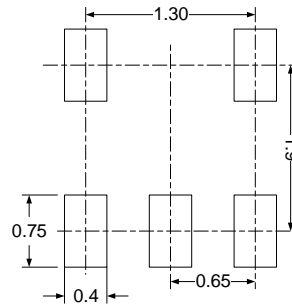
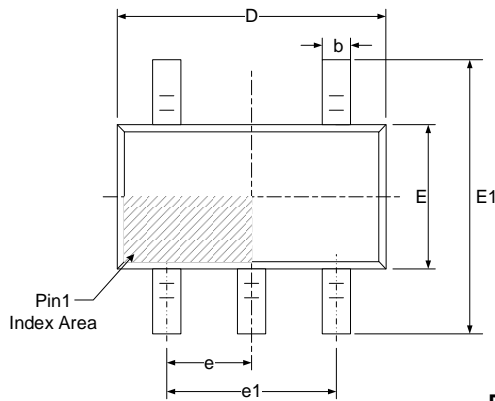
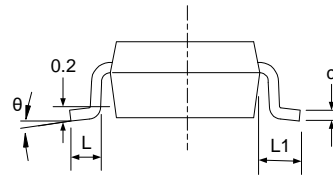
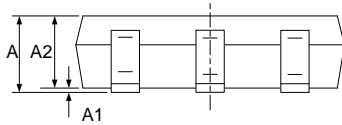

RECOMMENDED LAND PATTERN (Unit: mm)

Symbol	Dimensions In Millimeters		Dimensions In Inches	
	Min	Max	Min	Max
A	0.900	1.100	0.035	0.043
A1	0.000	0.100	0.000	0.004
A2	0.900	1.000	0.035	0.039
b	0.150	0.350	0.006	0.014
c	0.080	0.150	0.003	0.006
D	2.000	2.200	0.079	0.087
E	1.150	1.350	0.045	0.053
E1	2.150	2.450	0.085	0.096
e	0.650(BSC)		0.026(BSC)	
e1	1.300(BSC)		0.051(BSC)	
L	0.260	0.460	0.010	0.018
L1	0.525		0.021	
θ	0°	8°	0°	8°

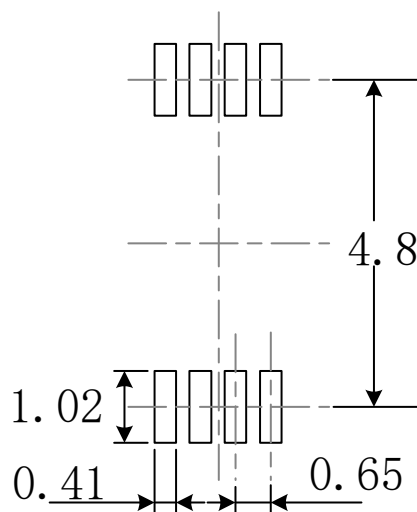
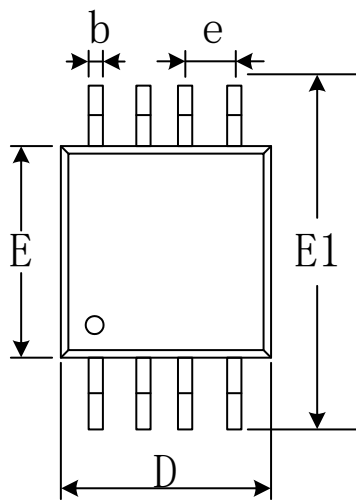
MSOP-8

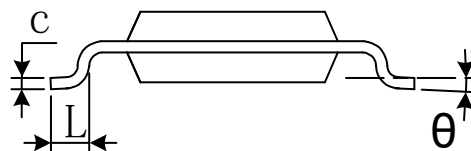
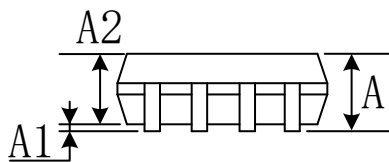

RECOMMENDED LAND PATTERN (Unit: mm)



Symbol	Dimensions In Millimeters		Dimensions In Inches	
	Min	Max	Min	Max
A	0.820	1.100	0.032	0.043
A1	0.020	0.150	0.001	0.006
A2	0.750	0.950	0.030	0.037
b	0.250	0.380	0.010	0.015
c	0.090	0.230	0.004	0.009
D	2.900	3.100	0.114	0.122
e	0.650(BSC)		0.026(BSC)	
E	2.900	3.100	0.114	0.122
E1	4.750	5.050	0.187	0.199
L	0.400	0.800	0.016	0.031
θ	0°	6°	0°	6°

TSSOP-8

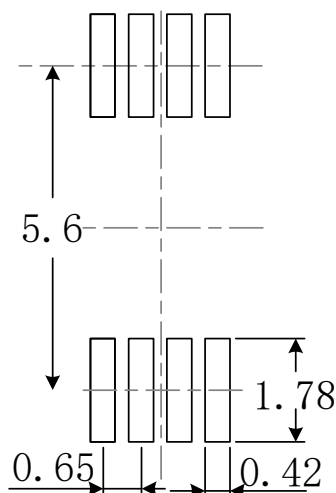
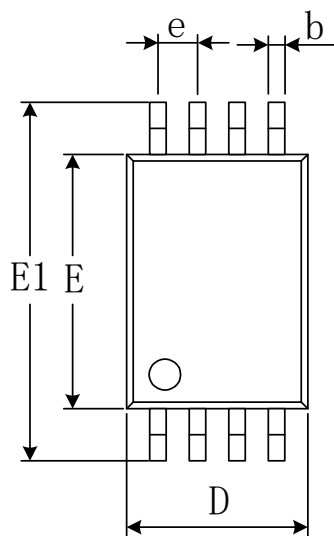
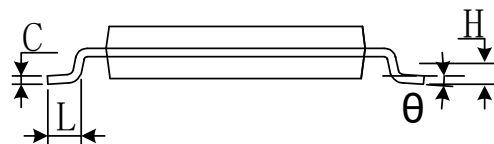
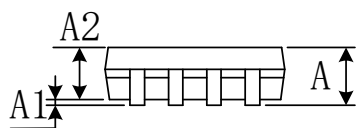

RECOMMENDED LAND PATTERN (Unit: mm)

Symbol	Dimensions In Millimeters		Dimensions In Inches	
	Min	Max	Min	Max
A		1.200		0.047
A1	0.050	0.150	0.002	0.006
A2	0.800	1.050	0.031	0.041
b	0.190	0.300	0.007	0.012
c	0.090	0.200	0.004	0.008
D	2.900	3.100	0.114	0.122
E	4.300	4.500	0.169	0.177
E1	6.250	6.550	0.246	0.258
e	0.650(BSC)		0.026(BSC)	
L	0.500	0.700	0.020	0.028
H	0.25(TYP)		0.01(TYP)	
θ	1°	7°	1°	7°

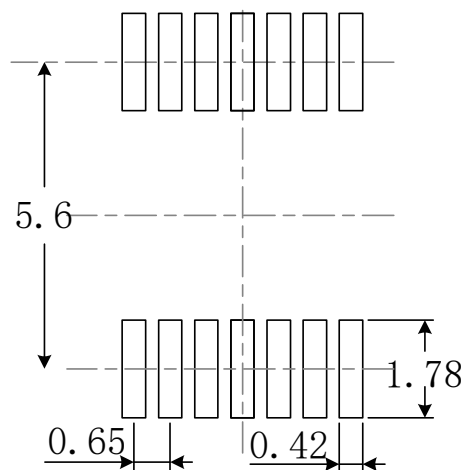
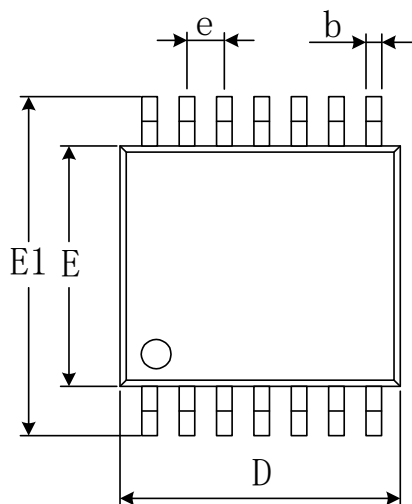
TSSOP-14

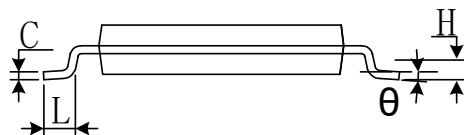
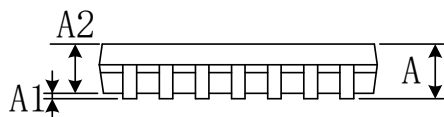

RECOMMENDED LAND PATTERN (Unit: mm)



Symbol	Dimensions In Millimeters		Dimensions In Inches	
	Min	Max	Min	Max
A		1.200		0.047
A1	0.050	0.150	0.002	0.006
A2	0.800	1.050	0.031	0.041
b	0.190	0.300	0.007	0.012
c	0.090	0.200	0.004	0.008
D	4.860	5.100	0.191	0.201
E	4.300	4.500	0.169	0.177
E1	6.250	6.550	0.246	0.258
e	0.650(BSC)		0.026(BSC)	
L	0.500	0.700	0.020	0.028
H	0.25(TYP)		0.01(TYP)	
θ	1°	7°	1°	7°

SOIC-8(SOP8)

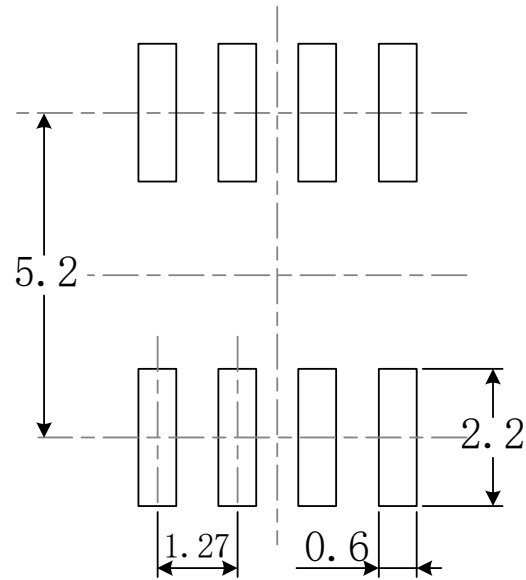
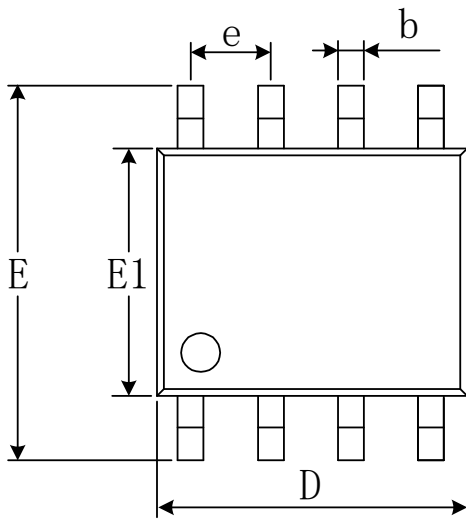

RECOMMENDED LAND PATTERN (Unit: mm)

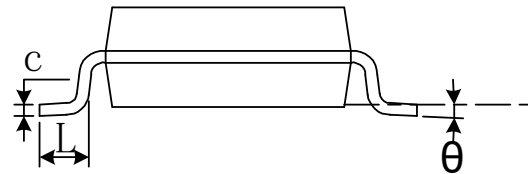
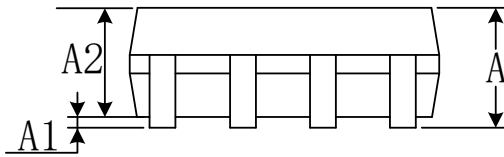

Symbol	Dimensions In Millimeters		Dimensions In Inches	
	Min	Max	Min	Max
A	1.350	1.750	0.053	0.069
A1	0.100	0.250	0.004	0.010
A2	1.350	1.550	0.053	0.061
b	0.330	0.510	0.013	0.020
c	0.170	0.250	0.007	0.010
D	4.800	5.000	0.189	0.197
e	1.270(BSC)		0.050(BSC)	
E	5.800	6.200	0.228	0.244
E1	3.800	4.000	0.150	0.157
L	0.400	1.270	0.016	0.050
θ	0°	8°	0°	8°

SOIC-14(SOP14)

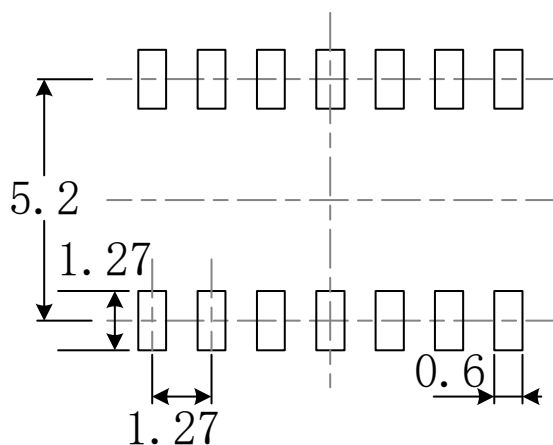
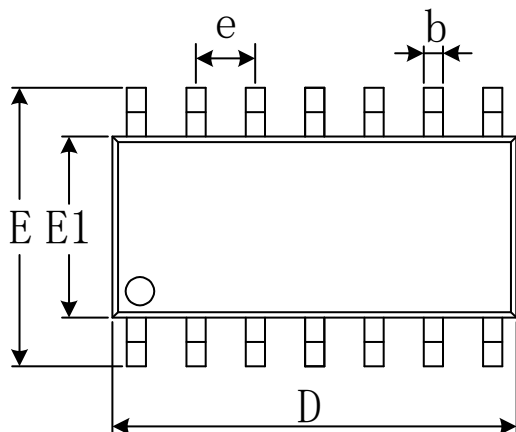

RECOMMENDED LAND PATTERN (Unit: mm)

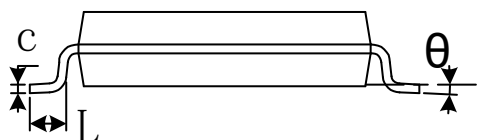
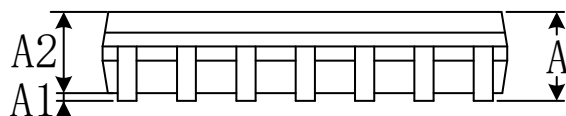

Symbol	Dimensions In Millimeters		Dimensions In Inches	
	Min	Max	Min	Max
A	1.350	1.750	0.053	0.069
A1	0.100	0.250	0.004	0.010
A2	1.350	1.550	0.053	0.061
b	0.310	0.510	0.012	0.020
c	0.100	0.250	0.004	0.010
D	8.450	8.850	0.333	0.348
e	1.270(BSC)		0.050(BSC)	
E	5.800	6.200	0.228	0.244
E1	3.800	4.000	0.150	0.157
L	0.400	1.270	0.016	0.050
θ	0°	8°	0°	8°