

Dual Channel, Ultra-Low Resistance Load Switch

General Description

The EM5209 is a small, ultra-low RON, dual channel load switch with controlled turn on. The device contains two N-channel MOSFETs that can operate over an input voltage range of 0.8V to 5.5V and can support a maximum continuous current of 6A per channel. Each switch is independently controlled by an on/off input (ON1 and ON2), which is capable of interfacing directly with low-voltage control signals. In EM5209, a 220-Ω on-chip load resistor is added for quick output discharge when switch is turned off.

The EM5209 is available in a small, space-saving DFN3X2 package with integrated thermal pad allowing for high power dissipation.

Ordering Information

Part Number	Package	Remark
EM5209VF	DFN3X2-14L	

Features

- Integrated dual channel load switch
- Input voltage range : 0.8V to 5.5V
- Ultra low R_{ON} resistance 20mΩ per channel
- 6A maximum continuous switch current per channel
- Low quiescent current 75uA (dual channel)
- Adjustable output rising time
- Quick Output Discharge (QOD)
- DFN3X2 14-pin package with Thermal Pad
- Bias voltage supports : 2.5V and 5.5V
- Over Temperature Protection

Applications



- Ultrabook
- Notebooks & Netbooks
- Tablet PC
- Consumer electronics
- Set-top boxes/Residential gateway
- Telecom systems
- Solid State Drives (SSD)

Pin Configuration

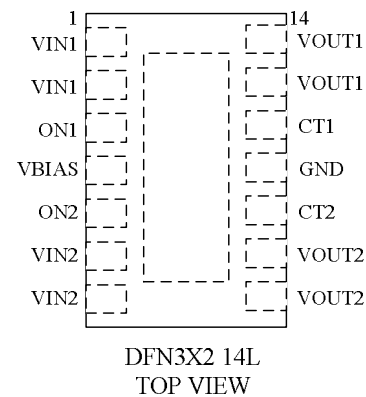

Typical Application Circuit

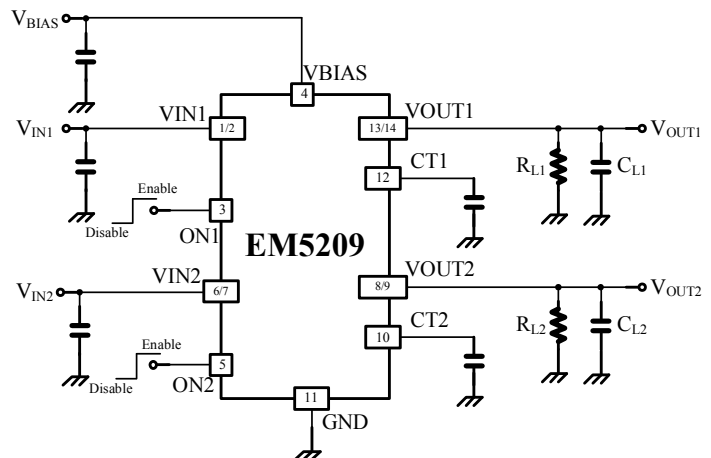

Pin Assignment

Pin Name	Pin No.	Pin Function
VIN1	1 / 2	Switch #1 input. Bypass this input with a ceramic capacitor to GND. Recommended voltage range for this pin for optimal RON performance is 0.8V to VBIAS.
ON1	3	Active high switch #1 control input. Do not leave floating.
VBIAS	4	Bias voltage. Power supply to the device. Recommended voltage range for this pin is 2.5V to 5.5V.
ON2	5	Active high switch #2 control input. Do not leave floating.
VIN2	6 / 7	Switch #2 input. Bypass this input with a ceramic capacitor to GND. Recommended voltage range for this pin for optimal RON performance is 0.8V to VBIAS.
VOUT2	8 / 9	Switch #2 output.
CT2	10	Switch #2 slew rate control. Can be left floating.
GND	11	Ground
CT1	12	Switch #1 slew rate control. Can be left floating.
VOUT1	13 / 14	Switch #1 output.
Thermal PAD	15	Thermal pad (exposed center pad) to alleviate thermal stress. Tie to GND.

Function Block Diagram

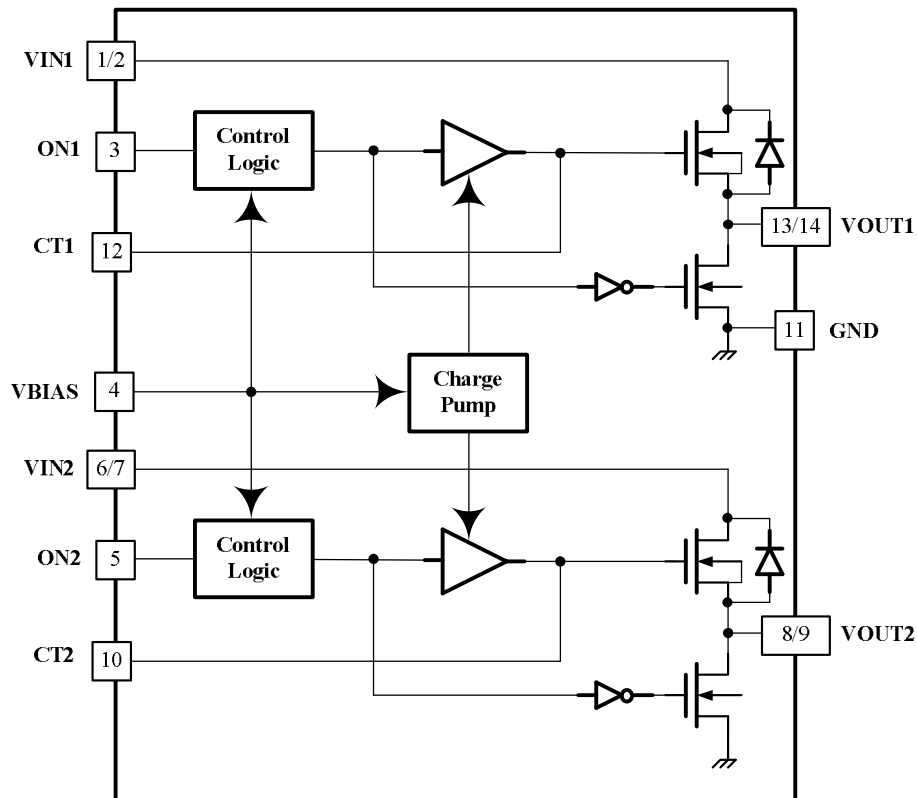

Absolute Maximum Ratings (Note1)

● $V_{IN1,2}$	-0.3V to +6.0V
● $V_{OUT1,2}$	-0.3V to +6.0V
● $V_{ON1,2}$	-0.3V to +6.0V
● Power Dissipation, P_D @ $T_A = 25^\circ\text{C}$, DFN3X2	1.53W
● Package Thermal Resistance, Θ_{JA} , DFN3X2 (Note 2).....	65°C/W
● Junction Temperature.....	150°C
● Lead Temperature (Soldering, 10 sec.).....	260°C
● Storage Temperature	-65°C to 150°C
● ESD susceptibility (Note3)	
HBM (Human Body Mode).....	2KV
MM (Machine Mode).....	200V

Recommended Operating Conditions (Note4)

● Bias Voltage, V_{BIAS}	+2.5V to +5.5V
● Supply Input Voltage, $V_{IN1,2}$	+0.8V to V_{BIAS}
● ON Voltage, $V_{ON1,2}$	+0V to V_{IN}
● Junction Temperature	-40°C to 125°C
● Ambient Temperature	-40°C to 85°C

Electrical Characteristics
 $V_{BIAS} = 5V$, $T_A = 25^\circ\text{C}$, unless otherwise specified

Parameter	Symbol	Test Conditions	Min	Typ	Max	Units	
Power Supplies and Currents Section							
VBIAS Quiescent current (both channels)	$I_{BIAS-ON-both}$	$I_{OUT1} = I_{OUT2} = 0$, $V_{IN1,2} = V_{ON1,2} = V_{BIAS} = 5V$		75	100	uA	
VBIAS Quiescent current (single channel)	$I_{BIAS-ON-single}$	$I_{OUT1} = I_{OUT2} = 0$, $V_{ON2} = 0V$ $V_{IN1,2} = V_{ON1} = V_{BIAS} = 5V$		60		uA	
VBIAS Shutdown current	$I_{BIAS-OFF}$	$V_{OUT1,2} = 0V$, $V_{ON1,2} = 0V$ $V_{IN1,2} = V_{BIAS} = 5V$			2	uA	
$V_{IN1,2}$ Off state supply current (per channel)	$I_{VIN-OFF}$	$V_{OUT1,2} = 0V$, $V_{ON1,2} = 0V$	$V_{IN1,2} = 5.0V$			2	uA
			$V_{IN1,2} = 3.3V$			2	
			$V_{IN1,2} = 1.8V$			2	
			$V_{IN1,2} = 0.8V$			1	
ON pin leakage current	I_{ON}	$V_{ON} = 5.5V$			1	uA	
Resistance Section							
ON-state Resistance	R_{ON}	$I_{OUT} = 200mA$, $V_{BIAS} = 5.0V$	$V_{IN} = 5.0V$		20	25	mΩ
			$V_{IN} = 3.3V$		20	25	
			$V_{IN} = 1.8V$		20	25	
			$V_{IN} = 1.5V$		20	25	
			$V_{IN} = 1.2V$		20	25	
Output Pull-down Resistance	R_{PD}	$V_{IN} = 5.0V$, $V_{ON} = 0V$, $I_{OUT} = 15mA$		220	300	Ω	

$V_{BIAS} = 2.5V, T_A = 25^\circ C$, unless otherwise specified

Parameter	Symbol	Test Conditions	Min	Typ	Max	Units	
Power Supplies and Currents Section							
VBIAS Quiescent current (both channels)	$I_{BIAS-ON-both}$	$I_{OUT1} = I_{OUT2} = 0, V_{IN1,2} = V_{ON1,2} = V_{BIAS} = 2.5V$		25	37	μA	
VBIAS Quiescent current (single channel)	$I_{BIAS-ON-single}$	$I_{OUT1} = I_{OUT2} = 0, V_{ON2} = 0V, V_{IN1,2} = V_{ON1} = V_{BIAS} = 2.5V$		20		μA	
VBIAS Shutdown current	$I_{BIAS-OFF}$	$V_{OUT1,2} = 0V, V_{ON1,2} = 0V, V_{IN1,2} = V_{BIAS} = 2.5V$			2	μA	
$V_{IN1,2}$ Off state supply current (per channel)	$I_{VIN-OFF}$	$V_{OUT1,2} = 0V, V_{ON1,2} = 0V$	$V_{IN1,2} = 2.5V$		2	μA	
			$V_{IN1,2} = 1.8V$		2		
			$V_{IN1,2} = 1.2V$		2		
			$V_{IN1,2} = 0.8V$		1		
ON pin leakage current	I_{ON}	$V_{ON} = 5.5V$			1	μA	
Resistance Section							
ON-state Resistance	R_{ON}	$I_{OUT} = 200mA, V_{BIAS} = 2.5V$	$V_{IN} = 2.5V$		22	29	$m\Omega$
			$V_{IN} = 1.8V$		22	29	
			$V_{IN} = 1.5V$		22	29	
			$V_{IN} = 1.2V$		22	29	
			$V_{IN} = 0.8V$		22	29	
Output Pull-down Resistance	R_{PD}	$V_{IN} = 2.5V, V_{ON} = 0V, I_{OUT} = 1mA$		260	320	Ω	
Over Temperature Protection							
Over Temperature Protection	T_{OTP}			150		$^\circ C$	
Hysteresis	T_{HYS}			30		$^\circ C$	

Switching Timing Diagrams

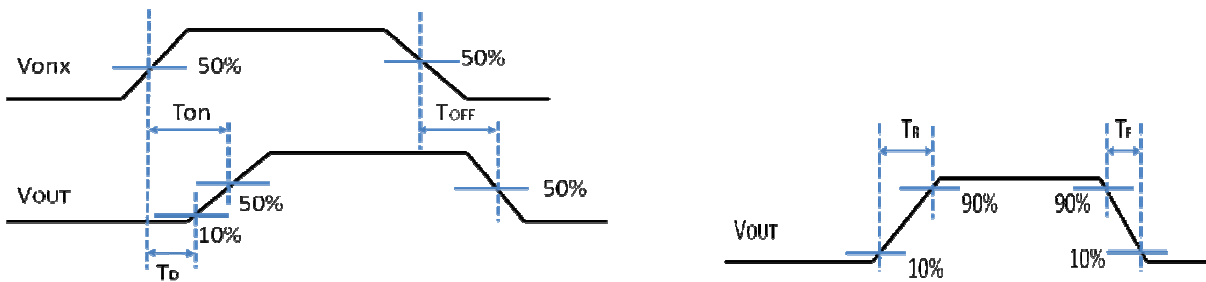

Switching characteristics

Parameter	Symbol	Test Conditions	Min	Typ	Max	Units
$V_{IN} = V_{ON} = V_{BIAS} = 5V, T_A = 25^\circ C$						
Turn-on time	T_{ON}	$R_L = 10\Omega, C_L = 0.1\mu F, C_T = 1000pF$		1210		μS
Turn-off time	T_{OFF}	$R_L = 10\Omega, C_L = 0.1\mu F, C_T = 1000pF$		6		μS
Vout Rising time	T_R	$R_L = 10\Omega, C_L = 0.1\mu F, C_T = 1000pF$		1370		μS
Vout falling time	T_F	$R_L = 10\Omega, C_L = 0.1\mu F, C_T = 1000pF$		2		μS
ON Delay time	T_D	$R_L = 10\Omega, C_L = 0.1\mu F, C_T = 1000pF$		460		μS

V_{IN}=0.8V, V_{ON}=V_{BIAS}=5V, T_A=25°C						
Turn-on time	T _{ON}	R _L =10Ω, C _L =0.1uF, C _T =1000pF		550		uS
Turn-off time	T _{OFF}	R _L =10Ω, C _L =0.1uF, C _T =1000pF		170		uS
Vout Rising time	T _R	R _L =10Ω, C _L =0.1uF, C _T =1000pF		325		uS
Vout falling time	T _F	R _L =10Ω, C _L =0.1uF, C _T =1000pF		16		uS
ON Delay time	T _D	R _L =10Ω, C _L =0.1uF, C _T =1000pF		400		uS
V_{IN}=2.5V, V_{ON}=5V, V_{BIAS}=2.5V, T_A=25°C						
Turn-on time	T _{ON}	R _L =10Ω, C _L =0.1uF, C _T =1000pF		2050		uS
Turn-off time	T _{OFF}	R _L =10Ω, C _L =0.1uF, C _T =1000pF		5		uS
Vout Rising time	T _R	R _L =10Ω, C _L =0.1uF, C _T =1000pF		2275		uS
Vout falling time	T _F	R _L =10Ω, C _L =0.1uF, C _T =1000pF		2.5		uS
ON Delay time	T _D	R _L =10Ω, C _L =0.1uF, C _T =1000pF		990		uS
V_{IN}=0.8V, V_{ON}=5V, V_{BIAS}=2.5V, T_A=25°C						
Turn-on time	T _{ON}	R _L =10Ω, C _L =0.1uF, C _T =1000pF		1300		uS
Turn-off time	T _{OFF}	R _L =10Ω, C _L =0.1uF, C _T =1000pF		130		uS
Vout Rising time	T _R	R _L =10Ω, C _L =0.1uF, C _T =1000pF		875		uS
Vout falling time	T _F	R _L =10Ω, C _L =0.1uF, C _T =1000pF		16		uS
ON Delay time	T _D	R _L =10Ω, C _L =0.1uF, C _T =1000pF		870		uS

Note 1. Stresses listed as the above “Absolute Maximum Ratings” may cause permanent damage to the device. These are for stress ratings. Functional operation of the device at these or any other conditions beyond those indicated in the operational sections of the specifications is not implied. Exposure to absolute maximum rating conditions for extended periods may remain possibility to affect device reliability.

Note 2. θ_{JA} is measured in the natural convection at T_A=25°C on a 4-layers high effective thermal conductivity test board with minimum copper area of JEDEC 51-7 thermal measurement standard.

Note 3. Devices are ESD sensitive. Handling precaution is recommended.

Note 4. The device is not guaranteed to function outside its operating conditions.

Output Rising Time Control

The table as below contains rise time values measured on a typical device. Rise time shown below are only valid for the power-on sequence where V_{IN} and V_{BIAS} are already in steady state condition, and the V_{ON} is high.

Rise Time (us)		10%-90% Vo Rising Time, CL=10Ω, Co=0.1uF						
	CT (nF)	0.8V	1.05V	1.5V	1.8V	2.5V	3.3V	5V
EM5209	0	26	32	40	50	49	64	95
	0.22	62	79	109	127	200	260	410
	0.47	107	130	210	271	384	489	825
	1	200	282	368	471	677	915	1590
	2.2	400	575	800	936	1621	2069	3398
	4.7	845	1159	1886	2530	3497	4497	6582
	10	1746	3133	4375	5502	7311	9967	16020

Typical Operating Characteristics
 VBIAS=5V ; TA=25°C

**Turn-on from V_{CNTL}
 (BOTH Channel)**

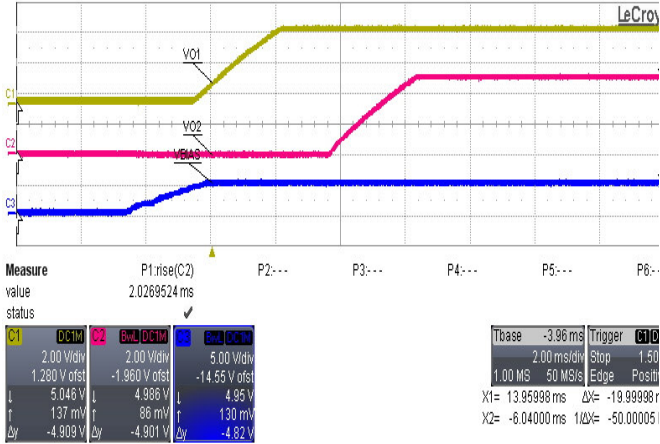

**Turn-on from Von1&Von2
 (BOTH Channel)**

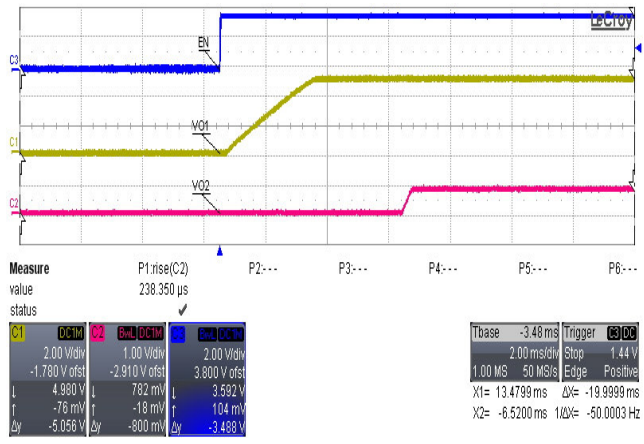

**Turn-off from Von1&Von2
 (BOTH Channel)**

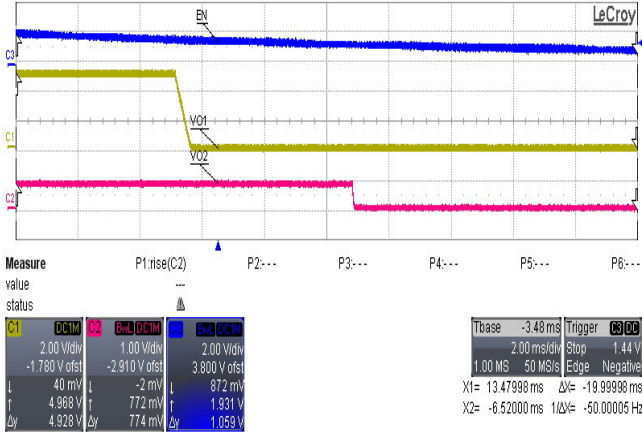

**Turn-on when Heavy load (3A)
 (Single Channel)**

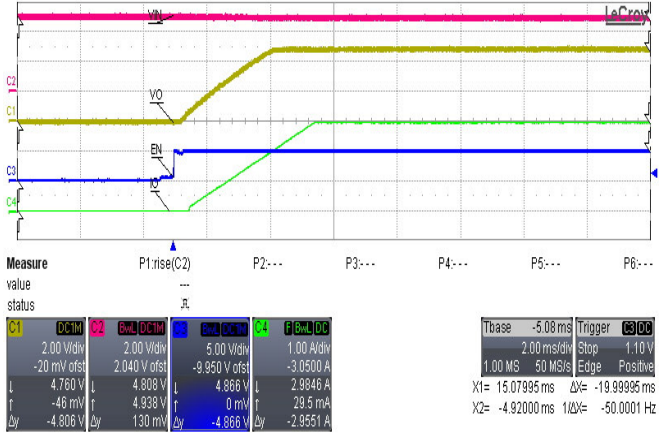

**VBIAS vs. Quiescent Current
 (Both Channel)**

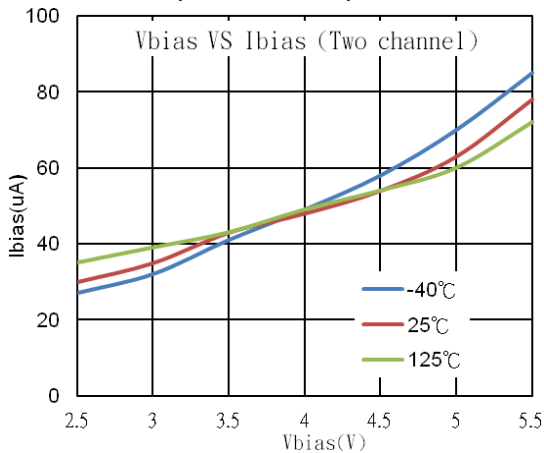

**VBIAS vs. Quiescent Current
 (Single Channel)**

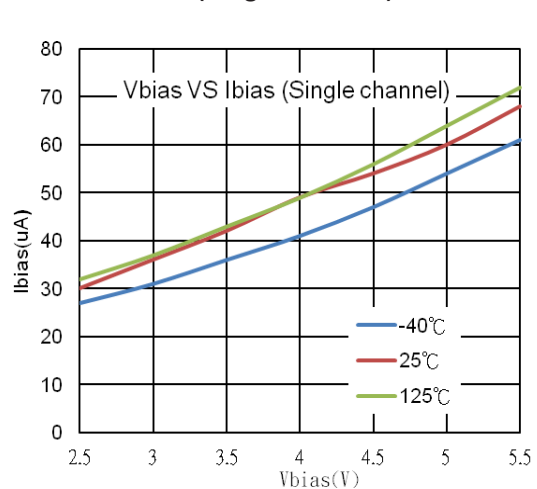

Typical Operating Characteristics

VBIAS vs. Shutdown Current (Both Channel)

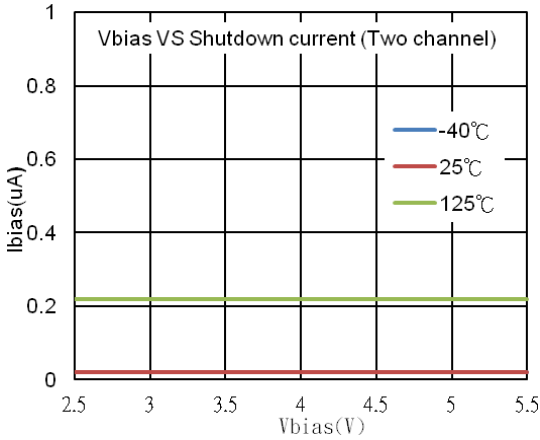

VIN vs. OFF-State Supply Current

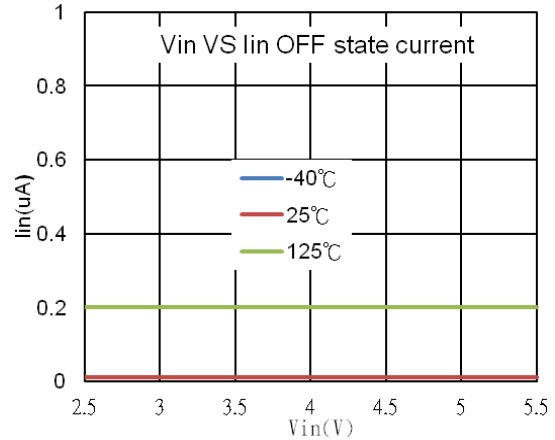

R_{on} vs. Temperature (VBIAS=5.5V)

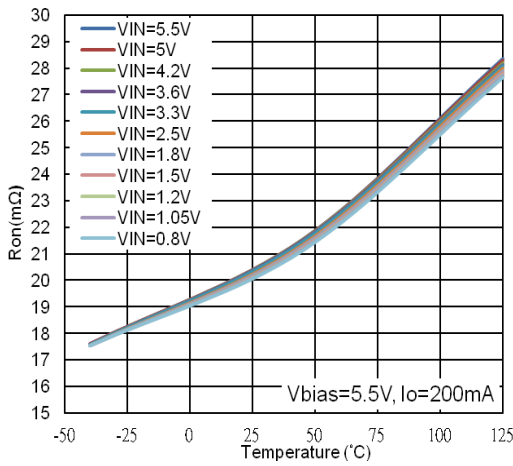

R_{on} vs. Temperature (VBIAS=2.5V)

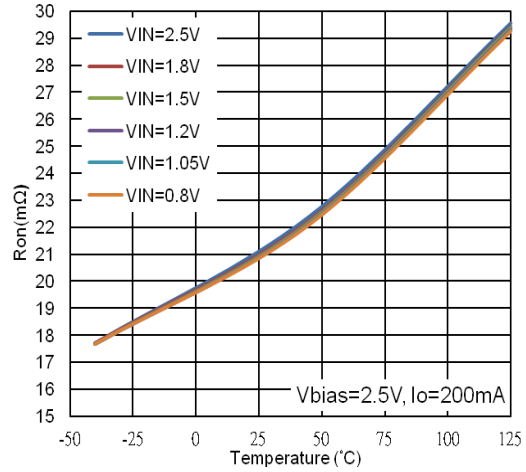

VIN vs. R_{PD} (VBIAS=2.5V)

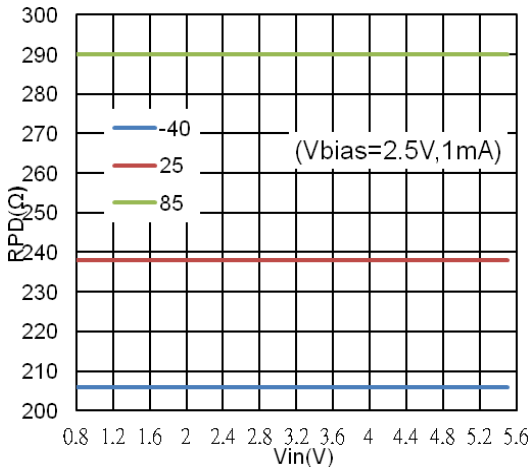

VON Threshold vs. Temperature

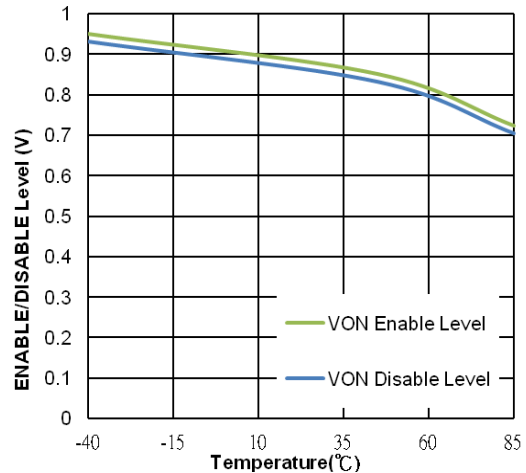

Typical Operating Characteristics

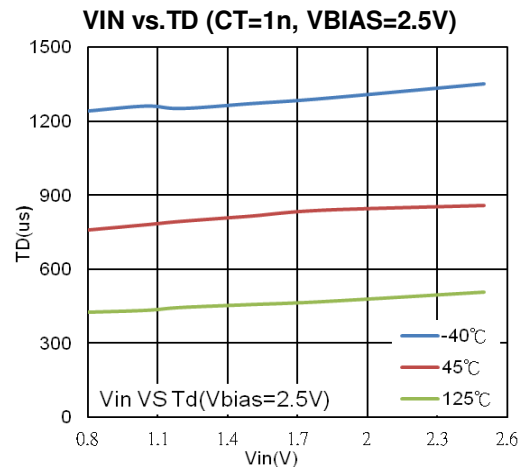
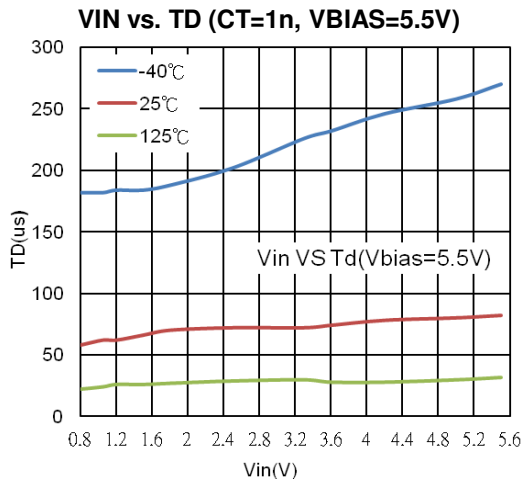
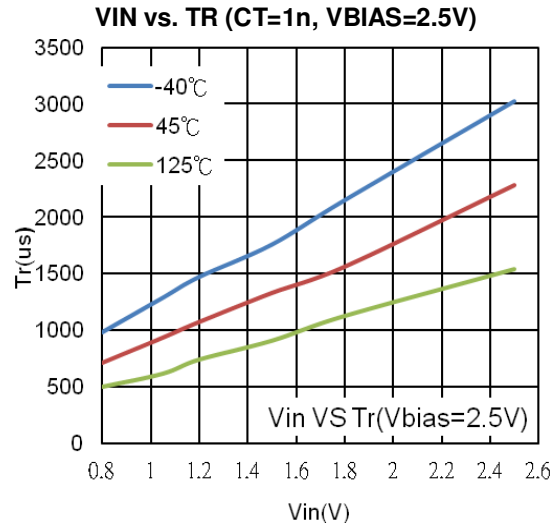
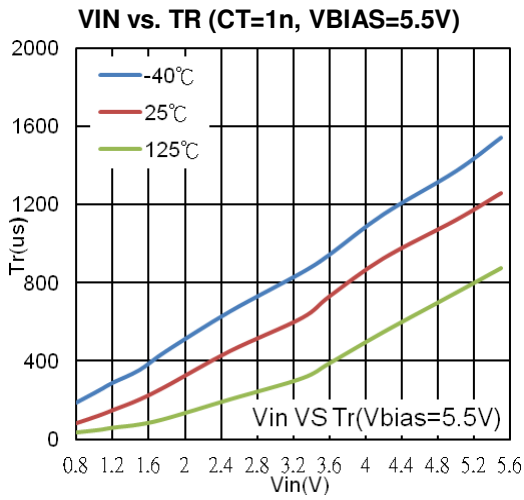

Functional Description

On-Resistance

The MOSFET gate voltage in the EM5209 is driven by an internal charge pump. The output voltage of the charge pump is dependent on the voltage on VBIAS pin. Care must be taken to ensure a sufficient VBIAS is used to keep the desired Ron when given the anticipated input voltage.

ON/OFF Control

EM5209 is enabled if the voltage of the Von pin is greater than logic high level and the VBIAS voltage has an adequate applied. If the voltage of the EN pin is less than logic low level, the device will be disabled.

Input Capacitor

The EM5209 do not require an input capacitor. In order to limit the voltage drop on the input supply caused by transient inrush current, an input bypass capacitor is recommended. A 1uF ceramic capacitor should be placed as closed as possible to the VIN pin. Higher values capacitor can help to further reduce the voltage drop.

Output Capacitor

Due to the integrated body diode in the NMOS switch, the CIN greater than Co is highly recommended. A CIN to Co ratio of 10 to 1 is recommended for minimizing VIN drop caused by inrush during startup. It also helps to prevent parasitic inductance forces Vo below GND when switching off. Output capacitor has minimal affect on device's turn on slew rate time.

Slew Rate Control

The slew rate of each channel output voltage can be controlled by the capacitor on the CT pin to GND which provides soft start functionality. This limits the inrush current caused by capacitor charging.

Thermal and Layout Consideration

EM5209 is designed to maintain a constant output load current. Due to physical limitations of the chip layout and assembly of the device the maximum switch current is 6A for each channel, the figure below show an example of typical PCB layout. All copper traces for the VIN and Vo pin should be widely and short to carry the maximum continuous current and obtain the best effect. The input and output capacitor (option) should be close to the device as possible to minimize the parasitic trace inductances and prevents the voltage drop when load transient.

The maximum IC junction temperature should be restricted to 125 °C under normal operating conditions. To calculate the maximum allowable dissipation, PD(MAX) for a given output current and ambient temperature, used the following equation:

$$P_{D(MAX)} = \frac{T_{J(MAX)} - T_A}{\theta_{JA}}$$

Where:

PD(MAX)=Maximum allowable power dissipation

TJ(MAX)=Maximum allowable junction temperature (125 °C for the EM5209)

TA=Ambient Temperature of the device

ΘJA= Junction to air thermal impedance. This parameter is also dependent upon PCB layout.

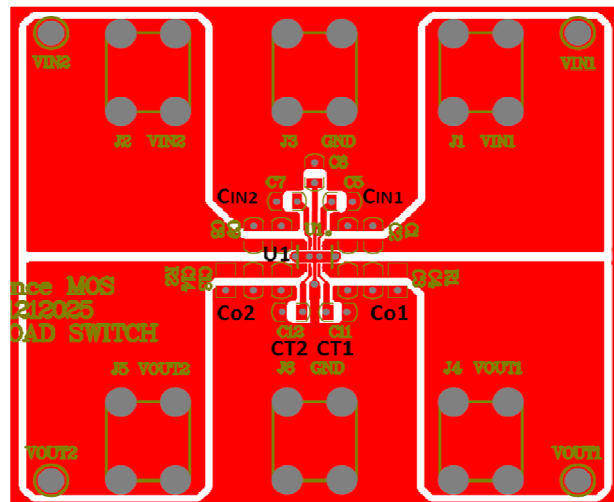

Marking Information

Device Name: EM5209VF for DFN3X2-14L

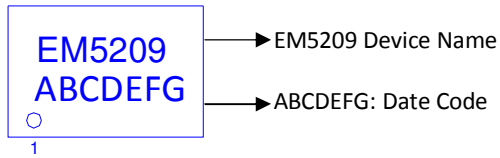

Outline Drawing

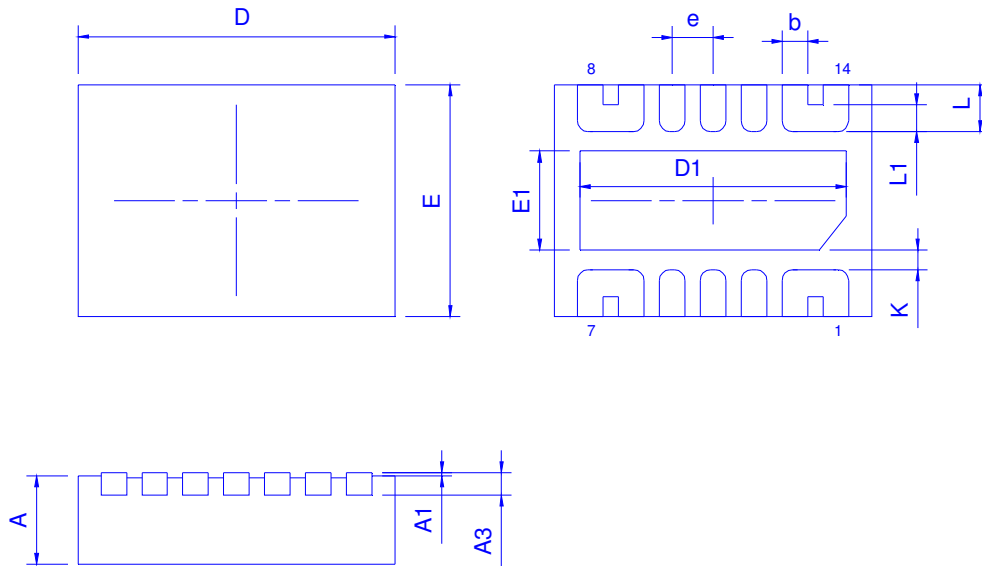

Dimension in mm

Dimension	A	A1	A3	b	D	E	D1	E1	e	L	K
Min.	0.7	0.00		0.13	2.9	1.9	2.4	0.7	0.3	0.200	0.15
Typ.			0.203		3.0	2.0					
Max.	0.8	0.05		0.25	3.1	2.1	2.6	1.0	0.5	0.426	0.35