

## Constant Off Time, Current-Mode Controller for LED Applications

### General Description

EM8800A is a constant off time current mode controller. This device can operated with a fixed off time of the power switch. The TOFF pin is provided to set the off time. In addition, the PWMD pin enables the user to use a PWM signal to modulate the switching pattern and adjust the average luminosity. The LD/SS pin enables the user to set peak current by adjust the voltage of this pin.

This part includes internal soft start, maximum on time protection, over current protection and thermal shutdown function. This part is available in SOP-8 package.

### Ordering Information

Part Number	Package	Remark
EM8800AG	SOP-8	

### Features

- Constant Off Time Current-Mode Control
- Adjustable Off Time
- Internal Leading Edge Blanking
- Internal Start Up Delay
- Maximum On Time Protection
- Over Current Protection
- Thermal Shutdown

### Applications

- LED Backlight or lighting
- RGB Backlight or lighting
- Organic Light-Emitting Diode Backlight or lighting
- AC-DC or DC-DC LED Driver applications.



### Pin Configuration

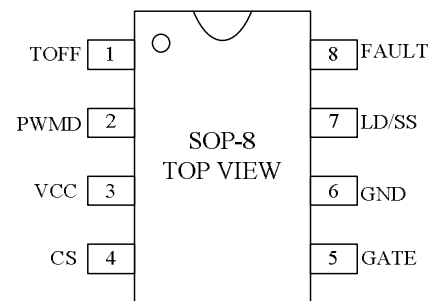

### Typical Application Circuit

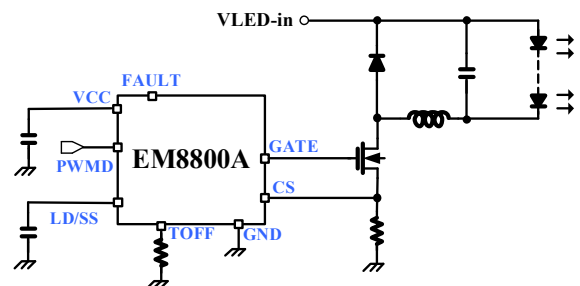

## Pin Assignment

Pin Name	Pin No.	Pin Function
TOFF	1	<b>OFF Time Setting.</b> A resistor to ground to set off time. Pulling this pin to ground will disable the device.
PWMD	2	<b>PWM Dimming.</b> This pin is used for PWM dimming. When the voltage applied to this pin is low, switching is inhibited. When the voltage applied to this pin is high, switching restarts.
VCC	3	<b>Supply Voltage.</b> This pin provides the bias supply for the EM8800A. The supply voltage is internally regulated to 5VDD for internal control circuit. Connect a well-decoupled supply voltage to this pin. Ensure that a decoupling capacitor is placed near the IC.
CS	4	<b>Current Sense Input.</b> This pin senses the peak current.
GATE	5	<b>Driver OUTPUT.</b> The output of the driver is connected to the gate of the external MOSFET.
GND	6	<b>Signal and Power Ground for the IC.</b> All voltages levels are measured with respect to this pin. Tie this pin to the ground island/plane through the lowest impedance connection available.
LD/SS	7	<b>Linear Dimming and Soft Start.</b> A capacitor connected to the pin sets the soft start period. The voltage of this pin adjusts the peak current.
FAULT	8	<b>Fault.</b> This pin is asserted high when a fault condition is detected.

**Function Block Diagram**

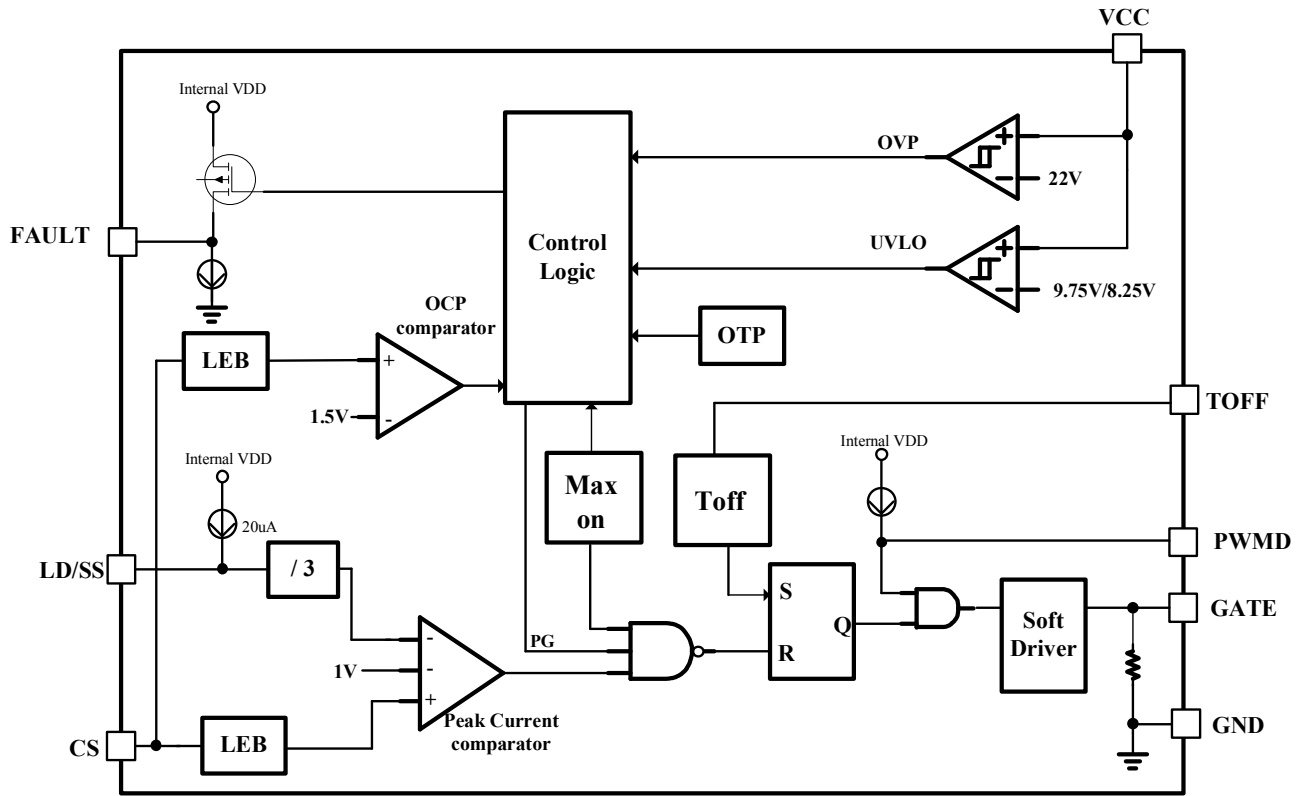

### Absolute Maximum Ratings (Note 1)

● Supply voltage, VCC-----	-0.3V to 24V
● GATE-----	-0.3V to 24V
● Other pins-----	0.3V to 6V
● Power Dissipation, PD @ TA = 25°C, SOP-8 -----	0.909W
● Package Thermal Resistance, $\theta_{JA}$ , SOP-8 (Note 2)-----	110°C/W
● Junction Temperature-----	150°C
● Lead Temperature (Soldering, 10 sec.)-----	260°C
● Storage Temperature Range-----	-65°C to 150°C
● ESD susceptibility (Note3)	
HBM (Human Body Mode)-----	2kV
MM (Machine Mode)-----	200V

### Recommended Operating Conditions (Note4)

● Junction Temperature -----	-40°C to 125°C
● Ambient Temperature -----	-40°C to 85°C

### Electrical Characteristics

V<sub>CC</sub>=12V, R<sub>TOFF</sub>=40kohm, T<sub>A</sub>=25°C, unless otherwise specified

Parameter	Symbol	Test Conditions	Pin	Min	Typ	Max	Units
<b>VCC Section</b>							
VCC OVP Protect voltage	V <sub>OVP</sub>			21	22	23.5	V
VCC On Threshold Voltage	V <sub>TH-ON</sub>			9.0	9.75	10.5	V
VCC Off Hysteresis Voltage	V <sub>TH-HY</sub>				1.5		V
Current Consumption in Latch Mode	I <sub>CC-LATCH</sub>				0.6	1.2	mA
Current Consumption in Start-up	I <sub>CC-OP1</sub>	V <sub>CC</sub> =V <sub>TH-ON</sub> -0.2V			0.05	0.1	mA
Current Consumption in Device Disable	I <sub>CC-OP2</sub>	V <sub>CC</sub> =12V, V <sub>PWMD</sub> =0V			0.6	1.2	mA
Current Consumption in Device Switching	I <sub>CC-OP3</sub>	C <sub>GATE</sub> =1nF F <sub>SW</sub> =60KHz			1.5	2.35	mA
<b>Gate Section</b>							
Rising Time	T <sub>R</sub>	C <sub>L</sub> = 1nF			80	140	ns
Falling Time	T <sub>F</sub>	C <sub>L</sub> = 1nF			30	60	ns
Output Voltage Low	V <sub>Source</sub>	20mA				1	V
Output Voltage High	V <sub>Sink</sub>	20mA		11			V
<b>Current-Sense Section</b>							
Maximum Internal Current Set-point	V <sub>CSLim</sub>			0.97	1	1.03	V
Leading Edge Blanking Time	T <sub>LEB</sub>			400	550	700	ns
Propagation Delay Time	T <sub>PD</sub>	V <sub>CS</sub> =V <sub>CSLim</sub> to V <sub>gate</sub> =1V, C <sub>gate</sub> =1nF		100	150	200	ns
Internal Soft-Start Period	T <sub>SS</sub>				2		ms

TOFF section							
Off Time	$T_{OFF}$	R_TOFF=30K ohm			6		us
		R_TOFF=10K ohm		1.8	2	2.2	us
Minimum Off Time	$T_{OFF-min}$	R_TOFF=1K ohm			0.435		us
Maximum Off Time	$T_{OFF-max}$	R_TOFF=60K ohm			12		us
TOFF Short Protection Trigger Level	$V_{TOFF-SHORT}$			0.3	0.4	0.5	V
Off Time Variation vs. VCC		VCC=9.5V to 16V				2	%
Off Time Variation vs. Temperature		-20°C to 105°C				5	%
PWM Section							
PWM ON Voltage Threshold	$V_{PWM-ON}$	$V_{PWM}$ increasing				2.2	V
PWM OFF Voltage Threshold	$V_{PWM-OFF}$	$V_{PWM}$ decreasing		0.8			V
PWM Pin Open Voltage	$V_{PWM-OPE}$				5		V
PWM Pin Internal Pull High Current	$I_{PWM}$			2	4	6	uA
Dimming Wake-up Time	$T_{WAKE}$	$V_{PWM} = V_{PWM-ON}$ to $V_{GATE} = 10V$				1	us
LD/SS Section							
LD/SS Pin Open Voltage	$V_{LD-OPEN}$				5		V
LD/SS Pin Internal Pull High Current	$I_{LD}$			18	20	22	uA
LD/SS Pin Voltage to Peak Current Ratio				2.85	3	3.15	V/V
FAULT Section							
FAULT Internal Pull Low Current	$I_{FA}$				6	10	uA
FAULT Pull high Voltage	$V_{FA-HIGH}$				5		V
FAULT Pull high Capability	$I_{FA-HIGH}$			1	2		mA
Protection Section							
Maximum On Time	$T_{ON-MAX}$				50		us
Over Current Trigger Level	$V_{OCP1}$			1.45	1.5	1.6	V
Suspend mode Vcs over voltage protection	$V_{OCP2}$			1.45	1.5	1.6	V
OCP Leading Edge Blanking Time	$T_{LEB-OCP}$				550		ns
Start-up Delay	$T_{START-DELAY}$			80	130	160	ms
Thermal Shutdown	$T_{SD}$			135	155		°C
Thermal Shutdown Hysteresis	$T_{SD-HYS}$				40		°C

**Note 1.** Stresses listed as the above “Absolute Maximum Ratings” may cause permanent damage to the device. These are for stress ratings. Functional operation of the device at these or any other conditions beyond those indicated in the operational sections of the specifications is not implied. Exposure to absolute maximum rating conditions for extended periods may remain possibility to affect device reliability.

**Note 2.**  $\theta_{JA}$  SOP-8 packages is 52°C /W on JEDEC 51-7 (4 layers,2S2P) thermal test board with 50mm<sup>2</sup> copper area.

**Note 3.** Devices are ESD sensitive. Handling precaution is recommended.

**Note 4.** The device is not guaranteed to function outside its operating conditions.

**Typical start-up sequence and possible type of steady-state operation.**

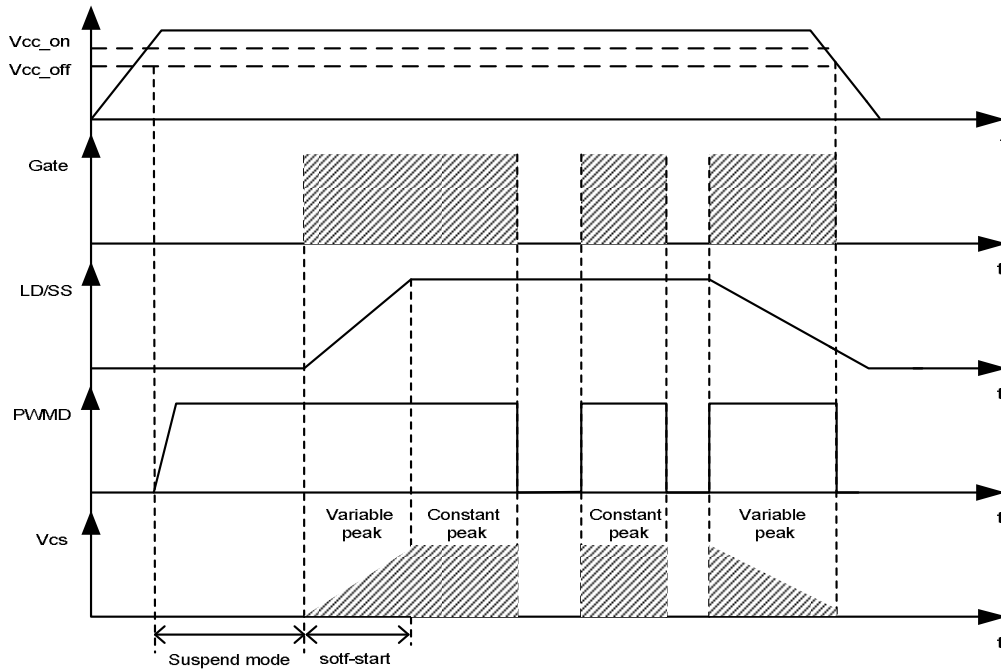

**Toff(us) time vs Rtoff(kohm) Adjustment Resistor**

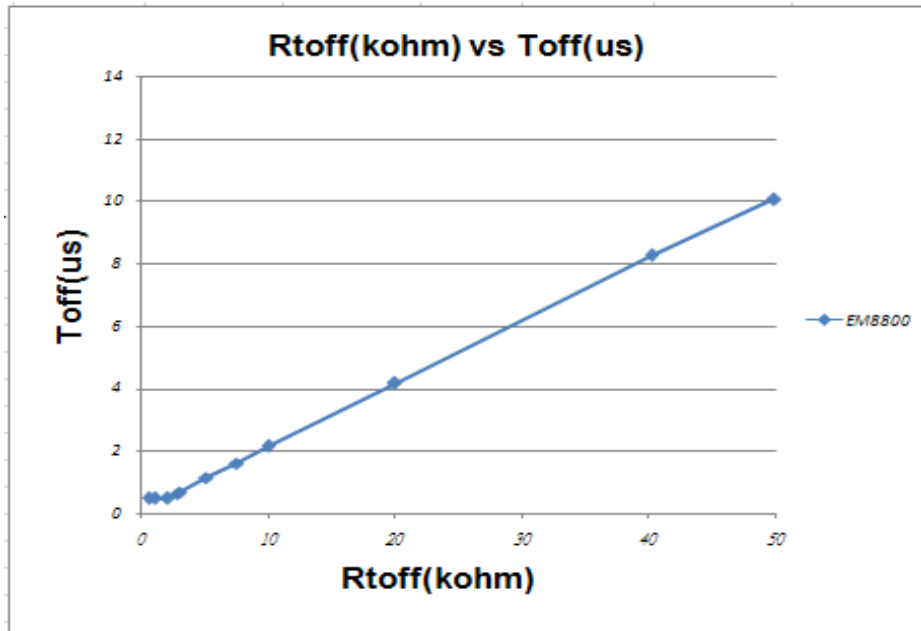

## Functional Description

EM8800A is a constant off time current mode controller. The PWMD pin enables the user to use a PWM signal to modulate the switching pattern and adjust the average luminosity. The LD/SS pin enables the user to set peak current by adjust the voltage of this pin. A capacitor connected to the LD/SS pin sets the soft start period.

### Supply Voltage

The  $V_{CC}$  pin provides the bias supply of EM8800A control circuit, as well as MOSFET's gate. A minimum 0.1uF ceramic capacitor is recommended to bypass the supply voltage.

### Power ON Reset

To let EM8800A start to operation,  $V_{CC}$  voltage must be higher than its POR voltage. Typical POR voltage is 9.75V.

### Start Up Delay

When  $V_{CC}$  reaches POR threshold, start-up-delay timer begins to count. When start-up-delay is finished, the current source of LD/SS pin is enabled and the soft-start sequence begins.

### Soft Start

A capacitor connected to the LD/SS pin sets the soft start period.

### Dimming

The device is able to perform both linear and PWM dimming. Two separate inputs are provided (LD/SS pin for linear dimming, PWMD pin for PWM dimming). The two functions can be used simultaneously and independently to one another. Linear dimming can be performed by applying a dc voltage between 0.3V and 3V. This voltage is internally processed, generating the reference level  $VCS\_LD$ . The relationship between VLD and  $VCS\_LD$  is:

$$VCS\_LD = VLD/3, \text{ when } VLD > 0.3V$$

$$VCS\_LD = 0.1V, \text{ when } VLD \leq 0.3V$$

PWM dimming can be achieved by driving the PWMD pin with a low frequency square wave signal. When the PWMD signal is lower than 0.8V, switching is inhibited. When the PWMD signal is higher than 2V, the switching is enabled.

### Constant Off-Time Generator

The off-time generator begins at the end of each on time. Once the off time generator has elapsed, it begins the next GATE pulse. The off-time is programmed by connecting a resistor from the TOFF pin to ground.

### Protections and Fault Flag

In case the LED string fails short, the inductor current will rise cycle by cycle without control. To prevent the current from exceeding levels that might lead to catastrophic failure of the power MOSFET, EM8800A detects if VCS exceeds 1.5V. If this occurs for eight consecutive switching cycles, a latched shutdown function is tripped: the device is stopped in an idle state and it is necessary to recycle its supply voltage to make it restart.

In case the LED string fails open, the current will drop to zero and the inductor current will never reach the programmed level. To detect this situation, an internal timer checks the ON time of the power MOSFET and, if it exceeds 30us for eight consecutive switching cycles, a latched shutdown function is tripped: the device is stopped in an idle state and it is necessary to recycle its supply voltage to make it restart.

In either case, the activation of the protection functions is signaled by FAULT pin asserted high, becoming a 5V voltage source able to provide up to 5mA source current.

**Ordering & Marking Information**

Device Name: EM8800AG for SOP-8

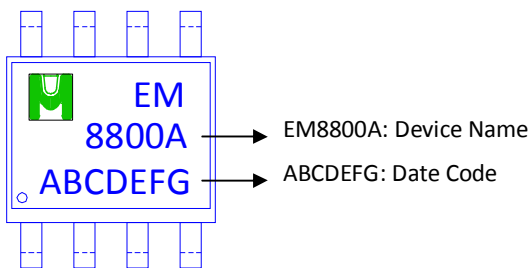

**Outline Drawing**

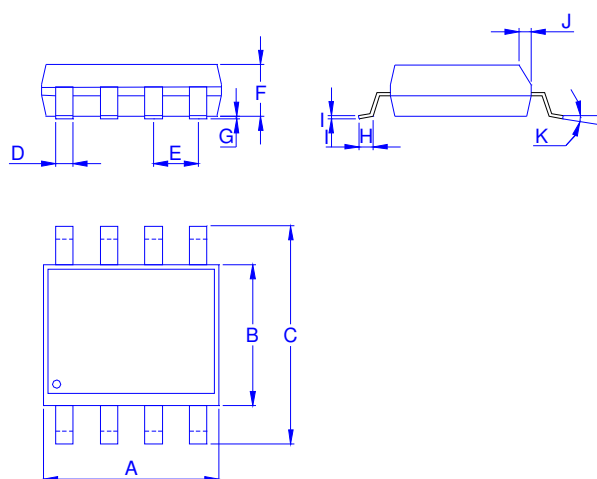

Dimension in mm

Dimension	A	B	C	D	E	F	G	H	I	J	K
Min.	4.70	3.70	5.80	0.33		1.20	0.08	0.40	0.19	0.25	0°
Typ.					1.27						
Max.	5.10	4.10	6.20	0.51		1.62	0.28	0.83	0.26	0.50	8°