

N-Channel Logic Level Enhancement Mode Field Effect Transistor

Product Summary:

BV_{DSS}	100V
$R_{DS(on)}$ (MAX.)	25m Ω
I_D	65A

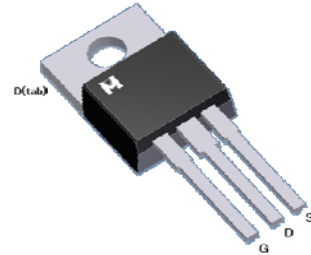
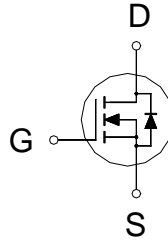

UIS, Rg 100% Tested

Pb-Free Lead Plating & Halogen Free



ABSOLUTE MAXIMUM RATINGS ($T_C = 25\text{ }^\circ\text{C}$ Unless Otherwise Noted)

PARAMETERS/TEST CONDITIONS		SYMBOL	LIMITS	UNIT
Gate-Source Voltage		V_{GS}	± 30	V
Continuous Drain Current	$T_C = 25\text{ }^\circ\text{C}$	I_D	65	A
	$T_C = 100\text{ }^\circ\text{C}$		45	
Pulsed Drain Current ¹		I_{DM}	180	
Avalanche Current		I_{AS}	30	
Avalanche Energy	$L = 0.1\text{mH}, I_D = 30\text{A}, R_G = 25\Omega$	E_{AS}	45	mJ
Repetitive Avalanche Energy ²	$L = 0.05\text{mH}$	E_{AR}	22.5	
Power Dissipation	$T_C = 25\text{ }^\circ\text{C}$	P_D	128	W
	$T_C = 100\text{ }^\circ\text{C}$		50	
Operating Junction & Storage Temperature Range		T_{j}, T_{stg}	-55 to 150	$^\circ\text{C}$

THERMAL RESISTANCE RATINGS

THERMAL RESISTANCE	SYMBOL	TYPICAL	MAXIMUM	UNIT
Junction-to-Case	$R_{\theta JC}$		0.97	$^\circ\text{C} / \text{W}$
Junction-to-Ambient	$R_{\theta JA}$		62.5	

¹Pulse width limited by maximum junction temperature.

²Duty cycle $\leq 1\%$



ELECTRICAL CHARACTERISTICS ($T_c = 25\text{ }^\circ\text{C}$, Unless Otherwise Noted)

PARAMETER	SYMBOL	TEST CONDITIONS	LIMITS			UNIT
			MIN	TYP	MAX	
STATIC						
Drain-Source Breakdown Voltage	$V_{(BR)DSS}$	$V_{GS} = 0V, I_D = 250\mu A$	100			V
Gate Threshold Voltage	$V_{GS(th)}$	$V_{DS} = V_{GS}, I_D = 250\mu A$	2.0	3.0	4.0	
Gate-Body Leakage	I_{GSS}	$V_{DS} = 0V, V_{GS} = \pm 30V$			± 100	nA
Zero Gate Voltage Drain Current	I_{DSS}	$V_{DS} = 80V, V_{GS} = 0V$			1	μA
		$V_{DS} = 70V, V_{GS} = 0V, T_J = 125\text{ }^\circ\text{C}$			25	
On-State Drain Current ¹	$I_{D(ON)}$	$V_{DS} = 10V, V_{GS} = 10V$	65			A
Drain-Source On-State Resistance ¹	$R_{DS(ON)}$	$V_{GS} = 10V, I_D = 30A$		21.5	25	m Ω
Forward Transconductance ¹	g_{fs}	$V_{DS} = 5V, I_D = 30A$		38		S
DYNAMIC						
Input Capacitance	C_{iss}	$V_{GS} = 0V, V_{DS} = 25V, f = 1MHz$		1575		pF
Output Capacitance	C_{oss}			216		
Reverse Transfer Capacitance	C_{rss}			47		
Gate Resistance	R_g	$V_{GS} = 15mV, V_{DS} = 0V, f = 1MHz$		1.5		Ω
Total Gate Charge ^{1,2}	Q_g	$V_{DS} = 80V, V_{GS} = 10V,$ $I_D = 30A$		20.8		nC
Gate-Source Charge ^{1,2}	Q_{gs}			8.5		
Gate-Drain Charge ^{1,2}	Q_{gd}			6.8		
Turn-On Delay Time ^{1,2}	$t_{d(on)}$	$V_{DS} = 50V,$ $I_D = 1A, V_{GS} = 10V, R_{GS} = 6\Omega$		20		nS
Rise Time ^{1,2}	t_r			80		
Turn-Off Delay Time ^{1,2}	$t_{d(off)}$			90		
Fall Time ^{1,2}	t_f			100		
SOURCE-DRAIN DIODE RATINGS AND CHARACTERISTICS ($T_c = 25\text{ }^\circ\text{C}$)						
Continuous Current	I_S				50	A
Pulsed Current ³	I_{SM}				150	
Forward Voltage ¹	V_{SD}	$I_F = I_S, V_{GS} = 0V$			1.3	V
Reverse Recovery Time	t_{rr}	$I_F = 25A, di_F/dt = 100A / \mu S$		120		nS
Reverse Recovery Charge	Q_{rr}				380	

¹Pulse test : Pulse Width $\leq 300\text{ }\mu\text{sec}$, Duty Cycle $\leq 2\%$.

²Independent of operating temperature.

³Pulse width limited by maximum junction temperature.

Ordering & Marking Information:

Device Name: EMD26N10E for TO-220

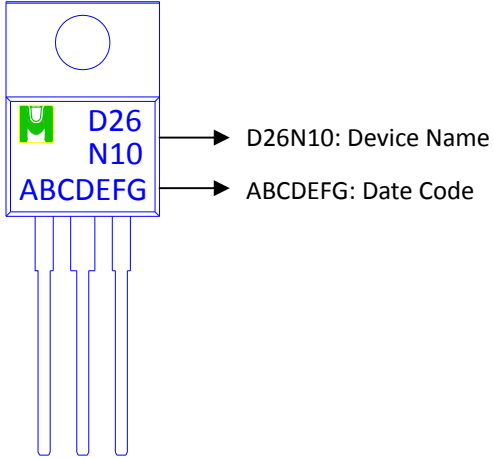



TYPICAL CHARACTERISTICS

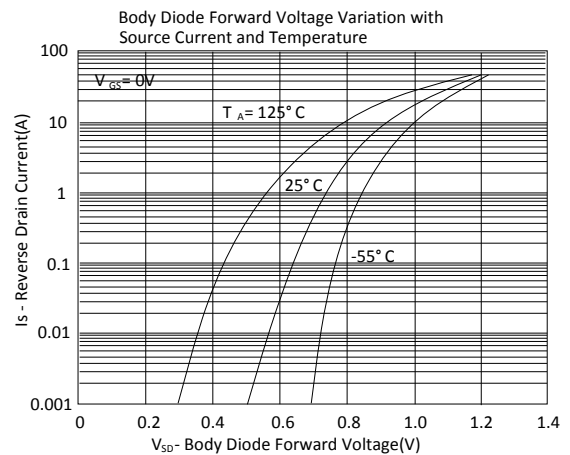
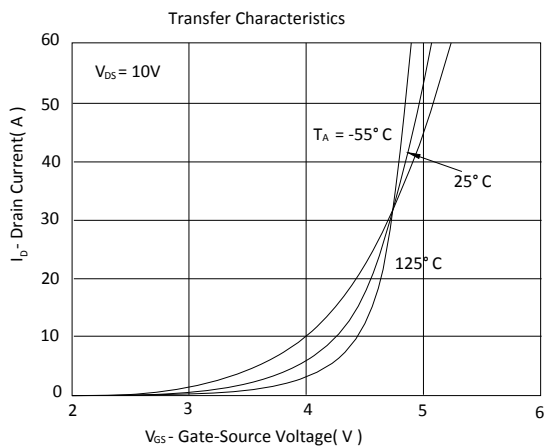
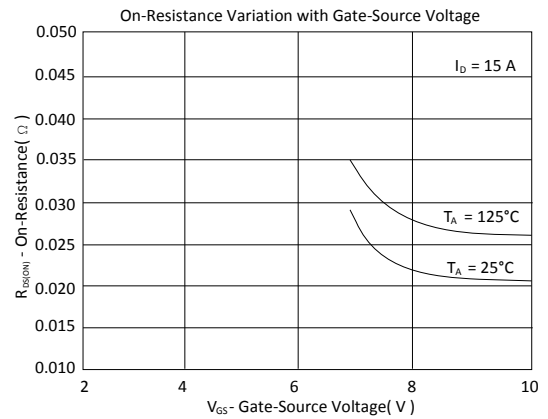
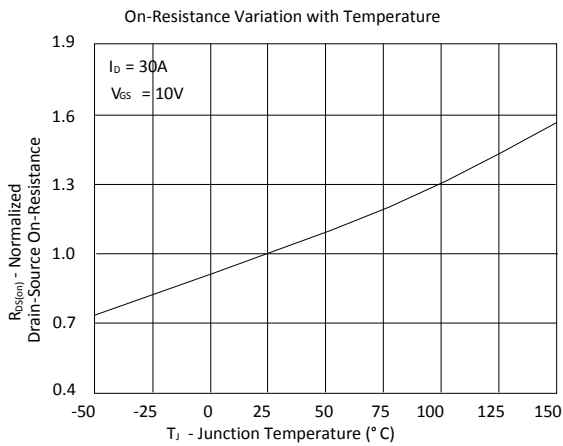
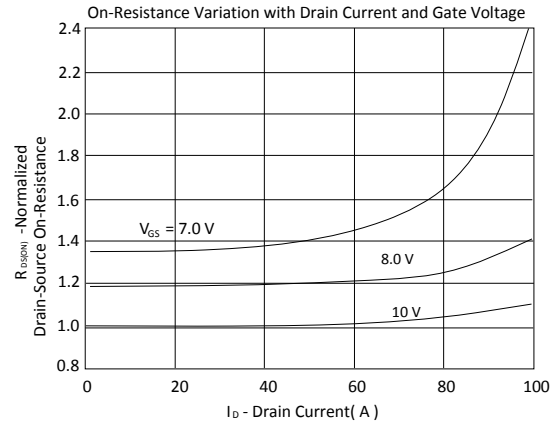
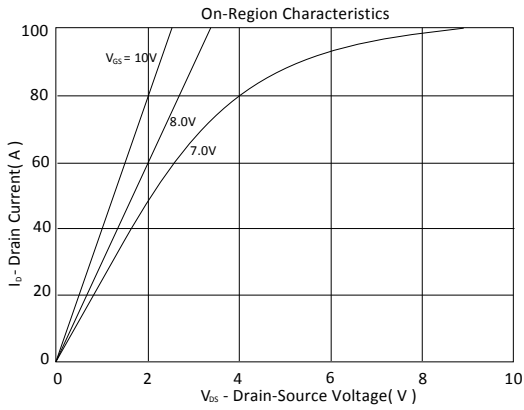

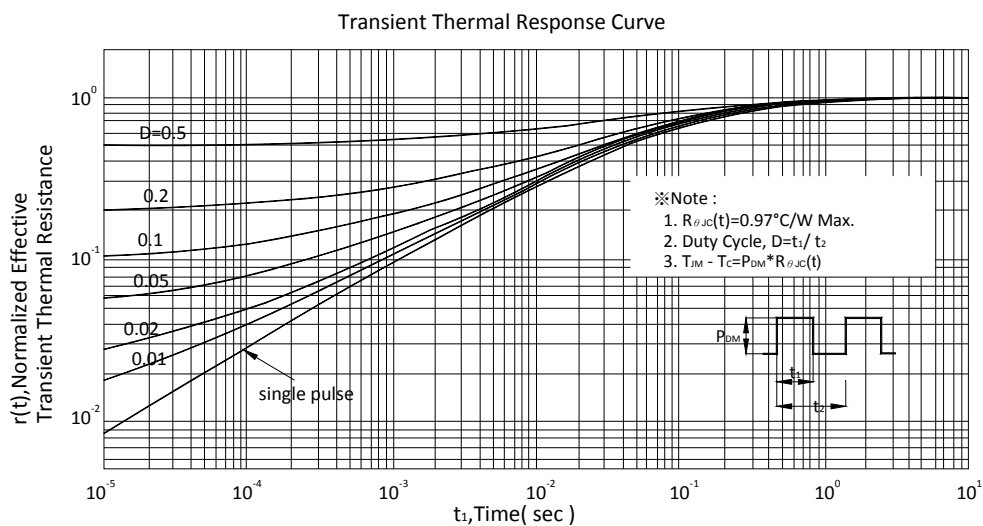
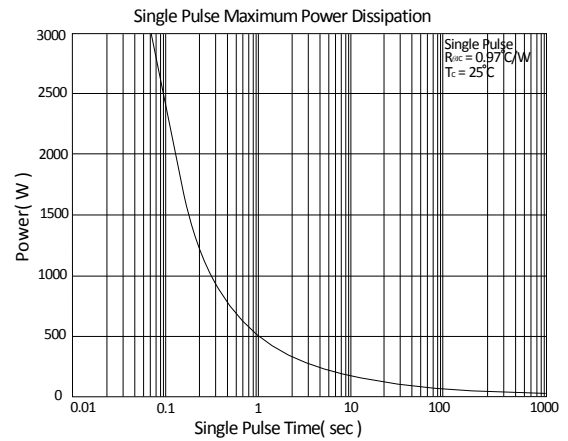
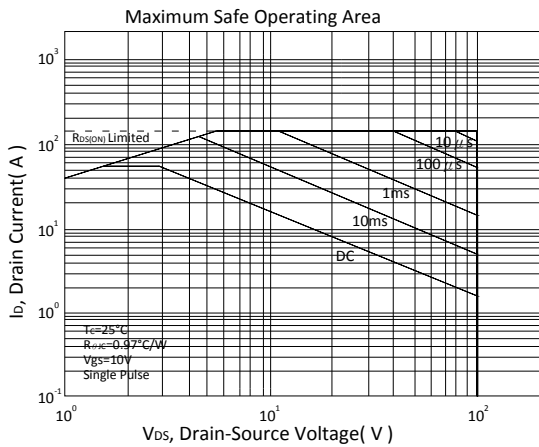
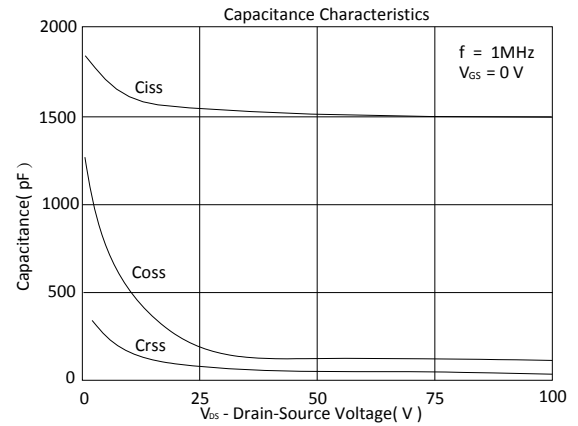
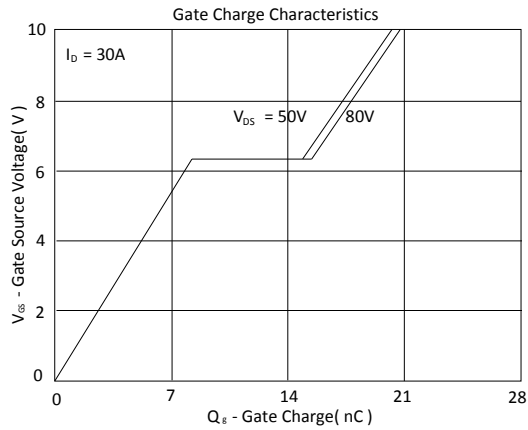



Outline Drawing

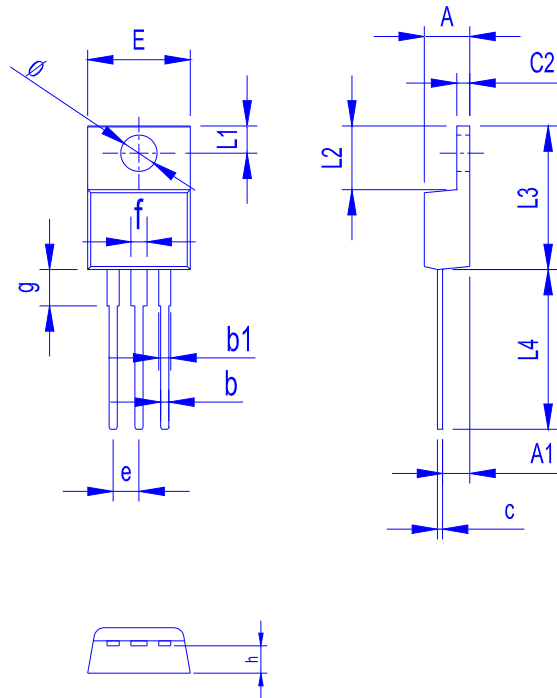

Dimension in mm

Dimension	A	b	b1	c	c2	E	L1	L2	L3	L4	ø	e	f	g	h
Min.	4.20	0.70	0.90	0.30	1.10	9.80	2.55	6.10	14.80	13.50	3.40	2.35	1.30	3.40	2.40
Max.	4.80	1.10	1.50	0.70	1.50	10.50	2.85	6.50	15.40	14.50	3.80	2.75	1.90	3.80	3.00