

N-Channel Logic Level Enhancement Mode Field Effect Transistor

Product Summary:

$BV_{DSS}$	40V
$R_{DS(on)}$ (MAX.)	4m $\Omega$
$I_D$	155A

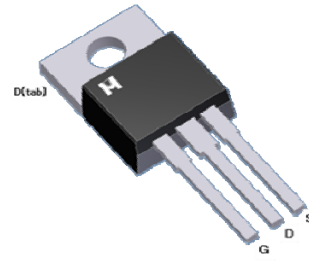

UIS, R<sub>g</sub> 100% Tested

Pb-Free Lead Plating & Halogen Free



ABSOLUTE MAXIMUM RATINGS ( $T_C = 25\text{ }^\circ\text{C}$  Unless Otherwise Noted)

PARAMETERS/TEST CONDITIONS		SYMBOL	LIMITS	UNIT
Gate-Source Voltage		$V_{GS}$	$\pm 20$	V
Continuous Drain Current	$T_C = 25\text{ }^\circ\text{C}$	$I_D$	155	A
	$T_C = 100\text{ }^\circ\text{C}$		110	
Pulsed Drain Current <sup>1</sup>		$I_{DM}$	540	
Avalanche Current		$I_{AS}$	80	
Avalanche Energy	$L = 0.1\text{mH}, I_D=80\text{A}, R_G=25\Omega$	$E_{AS}$	320	mJ
Repetitive Avalanche Energy <sup>2</sup>	$L = 0.05\text{mH}$	$E_{AR}$	160	
Power Dissipation	$T_C = 25\text{ }^\circ\text{C}$	$P_D$	227	W
	$T_C = 100\text{ }^\circ\text{C}$		73	
Operating Junction & Storage Temperature Range		$T_{j}, T_{stg}$	-55 to 150	$^\circ\text{C}$

100% UIS testing in condition of  $V_D=20\text{V}, L=0.1\text{mH}, V_G=10\text{V}, I_L=50\text{A}, \text{Rated } V_{DS}=40\text{V N-CH}$

THERMAL RESISTANCE RATINGS

THERMAL RESISTANCE	SYMBOL	TYPICAL	MAXIMUM	UNIT
Junction-to-Case	$R_{\theta JC}$		0.55	$^\circ\text{C} / \text{W}$
Junction-to-Ambient	$R_{\theta JA}$		62.5	

<sup>1</sup>Pulse width limited by maximum junction temperature.

<sup>2</sup>Duty cycle  $\leq 1\%$



ELECTRICAL CHARACTERISTICS ( $T_c = 25\text{ }^\circ\text{C}$ , Unless Otherwise Noted)

PARAMETER	SYMBOL	TEST CONDITIONS	LIMITS			UNIT
			MIN	TYP	MAX	
<b>STATIC</b>						
Drain-Source Breakdown Voltage	$V_{(BR)DSS}$	$V_{GS} = 0V, I_D = 250\mu A$	40			V
Gate Threshold Voltage	$V_{GS(th)}$	$V_{DS} = V_{GS}, I_D = 250\mu A$	2	3	4	
Gate-Body Leakage	$I_{GSS}$	$V_{DS} = 0V, V_{GS} = \pm 20V$			$\pm 100$	nA
Zero Gate Voltage Drain Current	$I_{DSS}$	$V_{DS} = 32V, V_{GS} = 0V$			1	$\mu A$
		$V_{DS} = 30V, V_{GS} = 0V, T_J = 125\text{ }^\circ\text{C}$			25	
On-State Drain Current <sup>1</sup>	$I_{D(ON)}$	$V_{DS} = 10V, V_{GS} = 10V$	155			A
Drain-Source On-State Resistance <sup>1</sup>	$R_{DS(ON)}$	$V_{GS} = 10V, I_D = 50A$		3.5	4.0	$m\Omega$
		$V_{GS} = 7V, I_D = 40A$		4.0	5.5	
Forward Transconductance <sup>1</sup>	$g_{fs}$	$V_{DS} = 5V, I_D = 50A$		35		S
<b>DYNAMIC</b>						
Input Capacitance	$C_{iss}$	$V_{GS} = 0V, V_{DS} = 25V, f = 1MHz$		3970		$pF$
Output Capacitance	$C_{oss}$			650		
Reverse Transfer Capacitance	$C_{rss}$			597		
Gate Resistance	$R_g$	$V_{GS} = 15mV, V_{DS} = 0V, f = 1MHz$		1.7		$\Omega$
Total Gate Charge <sup>1,2</sup>	$Q_g$	$V_{DS} = 20V, V_{GS} = 10V,$ $I_D = 20A$		83.6		nC
Gate-Source Charge <sup>1,2</sup>	$Q_{gs}$			18.7		
Gate-Drain Charge <sup>1,2</sup>	$Q_{gd}$			34.5		
Turn-On Delay Time <sup>1,2</sup>	$t_{d(on)}$	$V_{DS} = 20V,$ $I_D = 20A, V_{GS} = 10V, R_{GS} = 6\Omega$		50		nS
Rise Time <sup>1,2</sup>	$t_r$			120		
Turn-Off Delay Time <sup>1,2</sup>	$t_{d(off)}$			75		
Fall Time <sup>1,2</sup>	$t_f$			150		
<b>SOURCE-DRAIN DIODE RATINGS AND CHARACTERISTICS (<math>T_c = 25\text{ }^\circ\text{C}</math>)</b>						
Continuous Current	$I_S$				155	A
Pulsed Current <sup>3</sup>	$I_{SM}$				540	
Forward Voltage <sup>1</sup>	$V_{SD}$	$I_F = 50A, V_{GS} = 0V$			1.3	V
Reverse Recovery Time	$t_{rr}$	$I_F = 50A, di_F/dt = 100A / \mu S$		30		nS
Reverse Recovery Charge	$Q_{rr}$			200		nC

<sup>1</sup>Pulse test : Pulse Width  $\leq 300\ \mu\text{sec}$ , Duty Cycle  $\leq 2\%$ .

<sup>2</sup>Independent of operating temperature.

<sup>3</sup>Pulse width limited by maximum junction temperature.

Ordering & Marking Information:

Device Name: EMD04N04E for TO-220

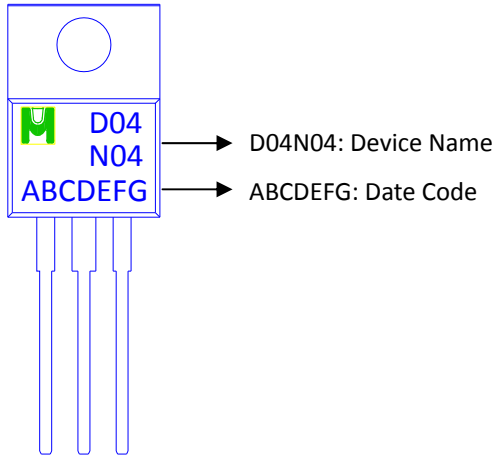



TYPICAL CHARACTERISTICS

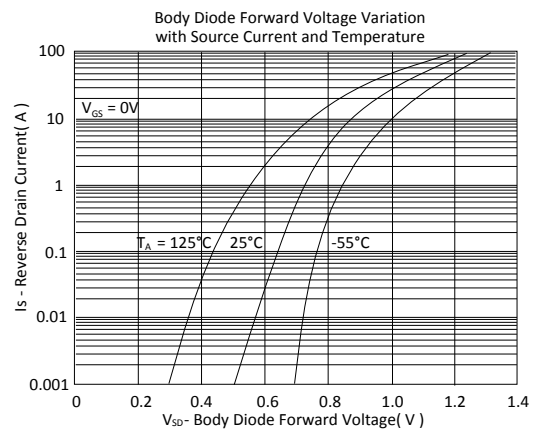
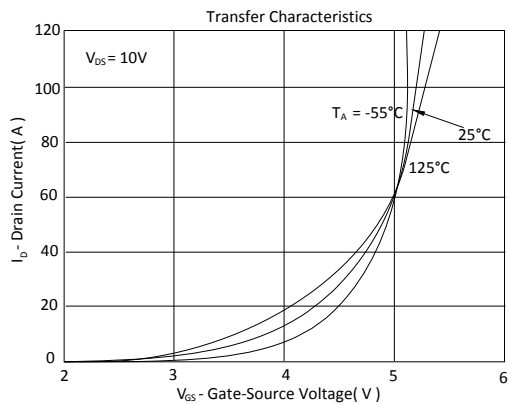
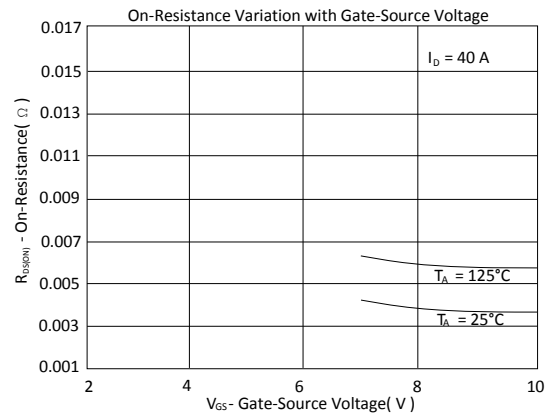
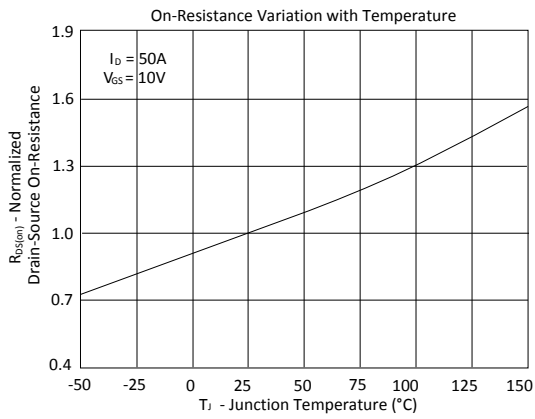
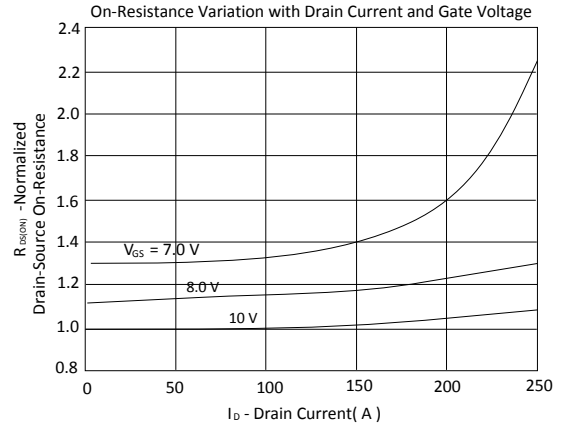
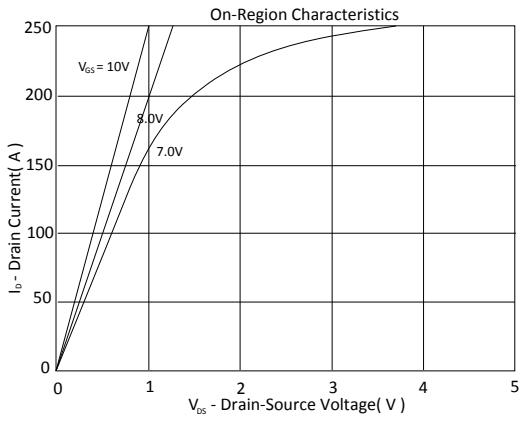

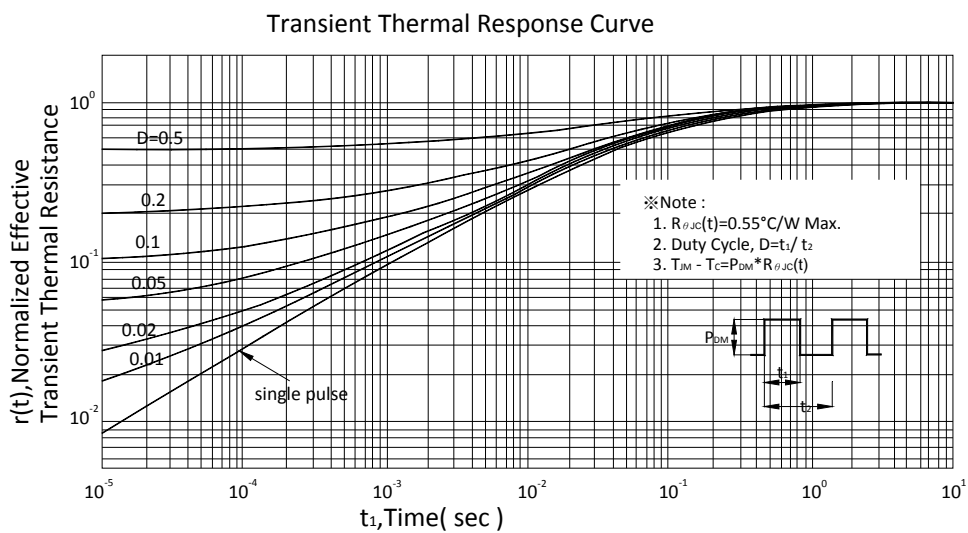
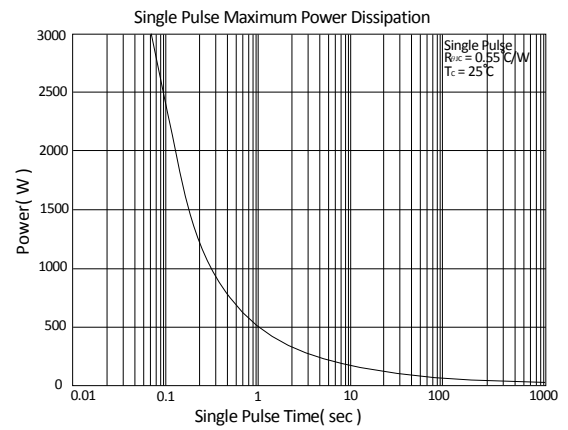
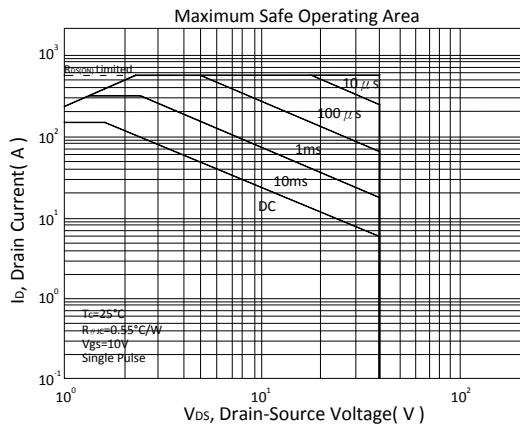
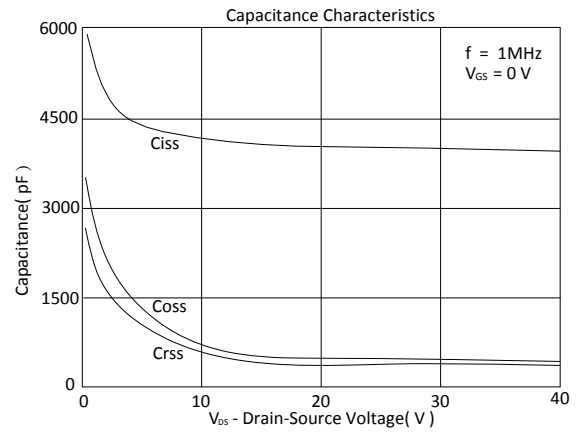
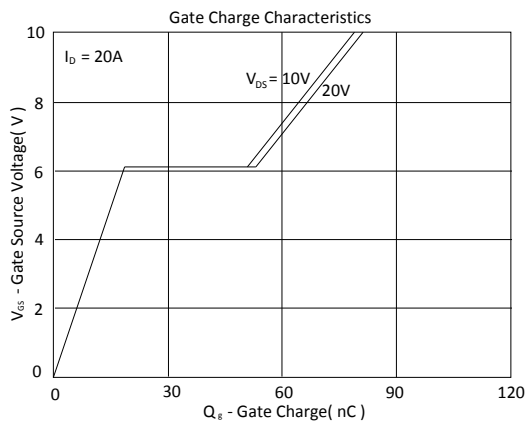



Outline Drawing

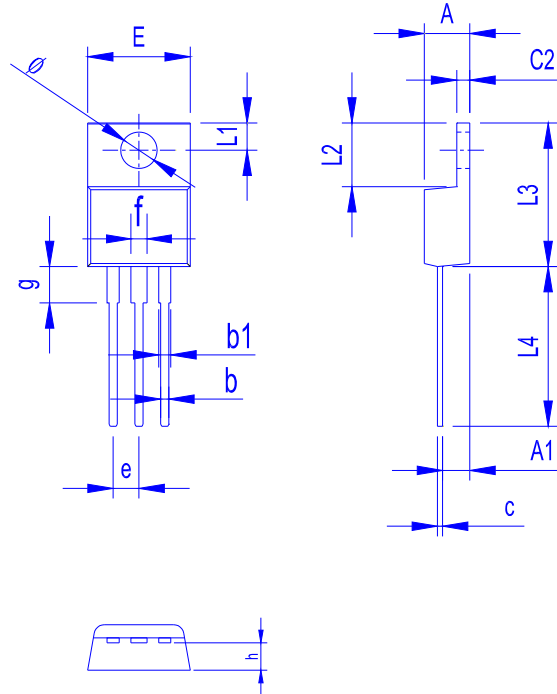

Dimension in mm

Dimension	A	b	b1	c	c2	E	L1	L2	L3	L4	∅	e	f	g	h
Min.	4.20	0.70	0.90	0.30	1.10	9.80	2.55	6.10	14.80	13.50	3.40	2.35	1.30	3.40	2.40
Max.	4.80	1.10	1.50	0.70	1.50	10.50	2.85	6.50	15.40	14.50	3.80	2.75	1.90	3.80	3.00