

**N-Channel Logic Level Enhancement Mode Field Effect Transistor**

**Product Summary:**

$BV_{DSS}$	60V
$R_{DS(on) (MAX.)}$	3.5m $\Omega$
$I_D$	180A

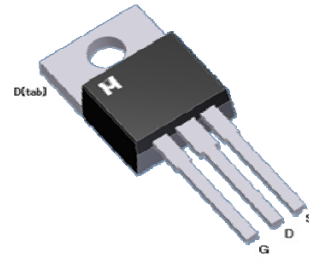

UIS, Rg 100% Tested

Pb-Free Lead Plating & Halogen Free



**ABSOLUTE MAXIMUM RATINGS ( $T_A = 25\text{ }^\circ\text{C}$  Unless Otherwise Noted)**

PARAMETERS/TEST CONDITIONS		SYMBOL	LIMITS	UNIT
Gate-Source Voltage		$V_{GS}$	$\pm 30$	V
Continuous Drain Current	$T_C = 25\text{ }^\circ\text{C}$	$I_D$	180	A
	$T_C = 100\text{ }^\circ\text{C}$		127	
Pulsed Drain Current <sup>1</sup>		$I_{DM}$	540	
Avalanche Current		$I_{AS}$	90	
Avalanche Energy	$L = 0.1\text{mH}, I_D=90\text{A}, R_G=25\Omega$	$E_{AS}$	405	mJ
Repetitive Avalanche Energy <sup>2</sup>	$L = 0.05\text{mH}$	$E_{AR}$	202	
Power Dissipation	$T_C = 25\text{ }^\circ\text{C}$	$P_D$	277	W
	$T_C = 100\text{ }^\circ\text{C}$		111	
Operating Junction & Storage Temperature Range		$T_{j}, T_{stg}$	-55 to 150	$^\circ\text{C}$

100% UIS testing in condition of  $V_D=30\text{V}, L=0.1\text{mH}, V_G=10\text{V}, I_L=60\text{A}, \text{Rated } V_{DS}=60\text{V N-CH}$

**THERMAL RESISTANCE RATINGS**

THERMAL RESISTANCE	SYMBOL	TYPICAL	MAXIMUM	UNIT
Junction-to-Case	$R_{\theta JC}$		0.45	$^\circ\text{C} / \text{W}$
Junction-to-Ambient	$R_{\theta JA}$		62.5	

<sup>1</sup>Pulse width limited by maximum junction temperature.

<sup>2</sup>Duty cycle  $\leq 1\%$



ELECTRICAL CHARACTERISTICS (T<sub>J</sub> = 25 °C, Unless Otherwise Noted)

PARAMETER	SYMBOL	TEST CONDITIONS	LIMITS			UNIT
			MIN	TYP	MAX	
<b>STATIC</b>						
Drain-Source Breakdown Voltage	V <sub>(BR)DSS</sub>	V <sub>GS</sub> = 0V, I <sub>D</sub> = 250μA	60			V
Gate Threshold Voltage	V <sub>GS(th)</sub>	V <sub>DS</sub> = V <sub>GS</sub> , I <sub>D</sub> = 250μA	2	3	4	
Gate-Body Leakage	I <sub>GSS</sub>	V <sub>DS</sub> = 0V, V <sub>GS</sub> = ±30V			±100	nA
Zero Gate Voltage Drain Current	I <sub>DSS</sub>	V <sub>DS</sub> = 48V, V <sub>GS</sub> = 0V			1	μA
		V <sub>DS</sub> = 40V, V <sub>GS</sub> = 0V, T <sub>J</sub> = 125 °C			25	
On-State Drain Current <sup>1</sup>	I <sub>D(ON)</sub>	V <sub>DS</sub> = 10V, V <sub>GS</sub> = 10V	180			A
Drain-Source On-State Resistance <sup>1</sup>	R <sub>DS(ON)</sub>	V <sub>GS</sub> = 10V, I <sub>D</sub> = 50A		3.1	3.5	mΩ
Forward Transconductance <sup>1</sup>	g <sub>fs</sub>	V <sub>DS</sub> = 5V, I <sub>D</sub> = 20A		60		S
<b>DYNAMIC</b>						
Input Capacitance	C <sub>iss</sub>	V <sub>GS</sub> = 0V, V <sub>DS</sub> = 30V, f = 1MHz		5519		pF
Output Capacitance	C <sub>oss</sub>			815		
Reverse Transfer Capacitance	C <sub>rss</sub>			50		
Gate Resistance	R <sub>g</sub>	V <sub>GS</sub> = 15mV, V <sub>DS</sub> = 0V, f = 1MHz		1.7		Ω
Total Gate Charge <sup>1,2</sup>	Q <sub>g</sub>	V <sub>DS</sub> = 30V, V <sub>GS</sub> = 10V, I <sub>D</sub> = 20A		61		nC
Gate-Source Charge <sup>1,2</sup>	Q <sub>gs</sub>			36		
Gate-Drain Charge <sup>1,2</sup>	Q <sub>gd</sub>			10		
Turn-On Delay Time <sup>1,2</sup>	t <sub>d(on)</sub>	V <sub>DS</sub> = 30V, I <sub>D</sub> = 20A, V <sub>GS</sub> = 10V, R <sub>GS</sub> = 6Ω		80		nS
Rise Time <sup>1,2</sup>	t <sub>r</sub>			160		
Turn-Off Delay Time <sup>1,2</sup>	t <sub>d(off)</sub>			100		
Fall Time <sup>1,2</sup>	t <sub>f</sub>			180		
<b>SOURCE-DRAIN DIODE RATINGS AND CHARACTERISTICS (T<sub>C</sub> = 25 °C)</b>						
Continuous Current	I <sub>S</sub>				180	A
Pulsed Current <sup>3</sup>	I <sub>SM</sub>				540	
Forward Voltage <sup>1</sup>	V <sub>SD</sub>	I <sub>F</sub> = 50A, V <sub>GS</sub> = 0V			1.3	V
Reverse Recovery Time	t <sub>rr</sub>	I <sub>F</sub> = 20A, dI <sub>F</sub> /dt = 100A / μS		35		nS
Reverse Recovery Charge	Q <sub>rr</sub>				270	

<sup>1</sup>Pulse test : Pulse Width ≤ 300 μsec, Duty Cycle ≤ 2%.

<sup>2</sup>Independent of operating temperature.

<sup>3</sup>Pulse width limited by maximum junction temperature.

Ordering & Marking Information:

Device Name: EMD03N06E for TO-220

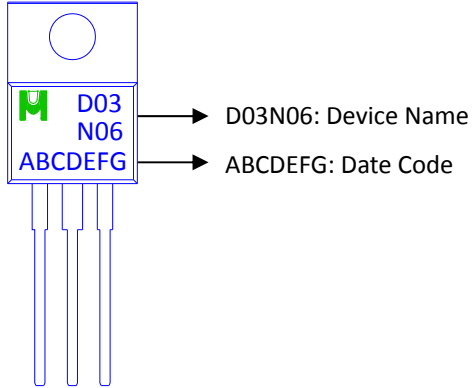



TYPICAL CHARACTERISTICS

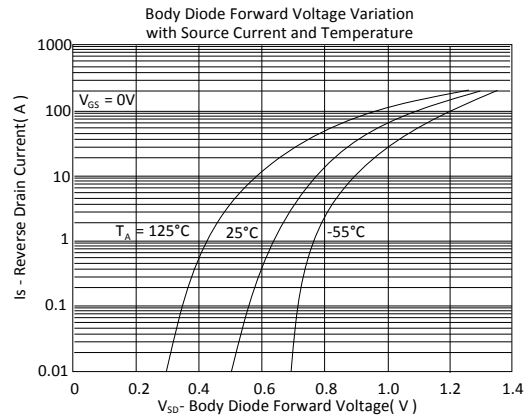
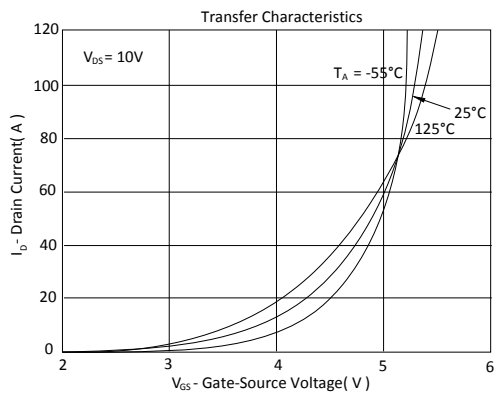
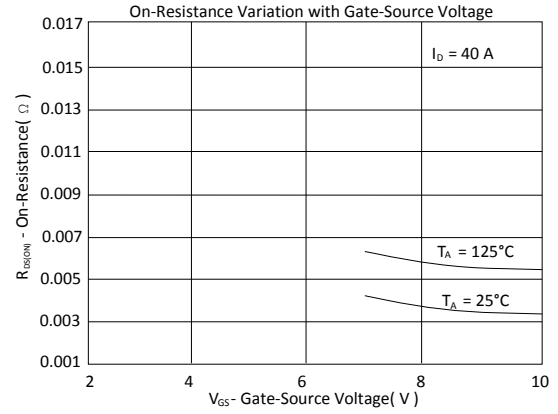
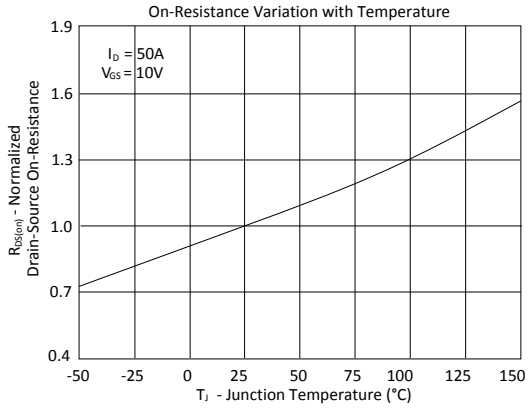
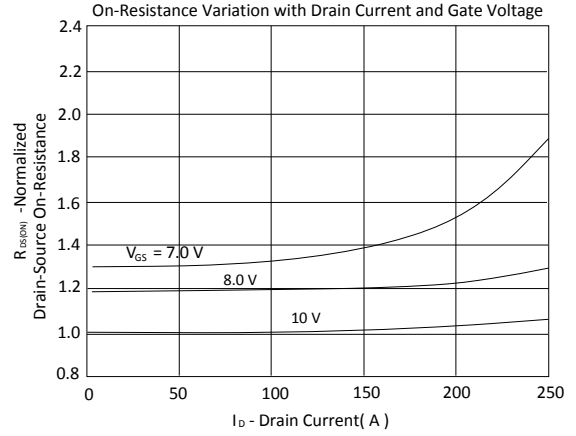
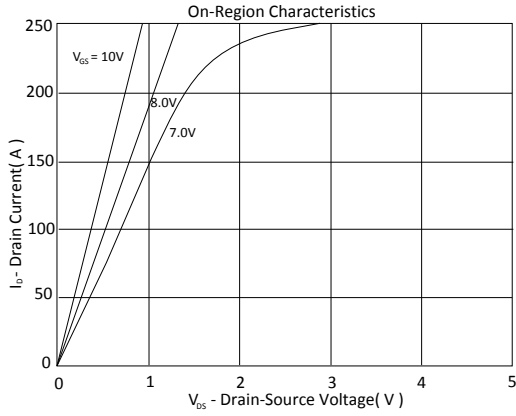

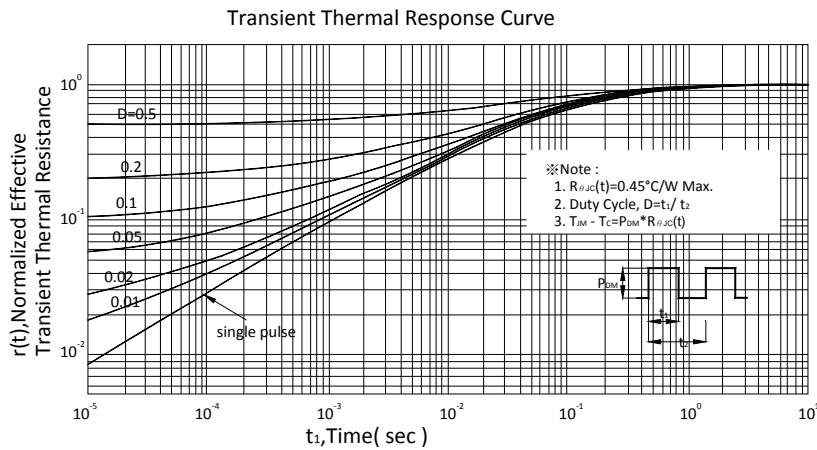
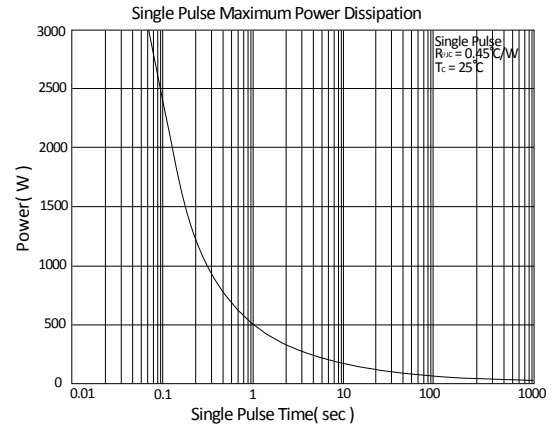
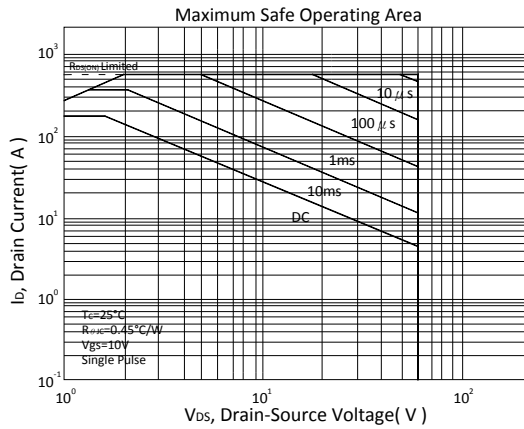
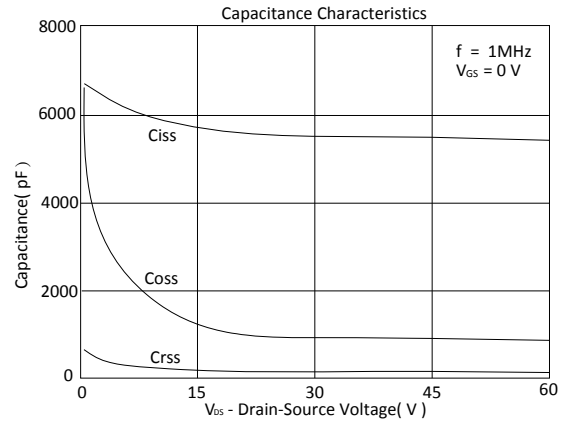
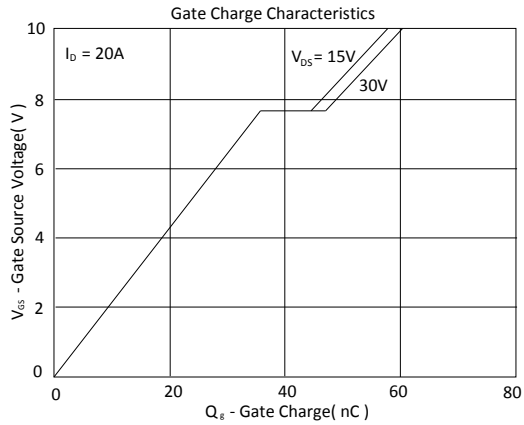



Outline Drawing

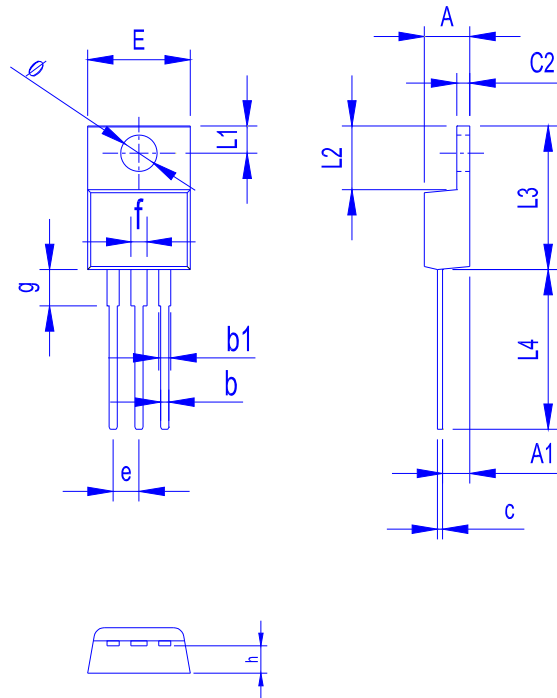

Dimension in mm

Dimension	A	b	b1	c	c2	E	L1	L2	L3	L4	$\phi$	e	f	g	h
Min.	4.20	0.70	0.90	0.30	1.10	9.80	2.55	6.10	14.80	13.50	3.40	2.35	1.30	3.40	2.40
Max.	4.80	1.10	1.50	0.70	1.50	10.50	2.85	6.50	15.40	14.50	3.80	2.75	1.90	3.80	3.00