

# 1A Low Dropout Adjustable and Fixed Mode Regulator

## General Description

The EM1109 performs ultra- low drop voltage, high power supply rejection ratio (PSRR), fast response, low noise linear regulator, and designed to continuously deliver up to 1A output current. The EM1109 has wide adjustable output voltage range and high output accuracy to 1.5%.

No by-pass capacitor is needed for this device and only 4.7uF ceramic capacitor is required for stability in any loading conditions. It reduces the amount of board space necessary for power applications.

The other features include soft start, current limit protection, Power-On-Reset function, and over temperature protection. The EM1109 is available in DFN3X3-08L package.

## Ordering Information

Part Number	Package	XX: Output Voltage
EM1109V-XX	DFN3X3-08L	AD: Adjust
		10: 1.0V
		12: 1.2V
		15: 1.5V
		18: 1.8V
		25: 2.5V
		30: 3.0V
		33: 3.3V

## Features

- Ultra Fast Response in Line/Load Transient
- Wide  $V_{IN}$  Range from 2.5V to 5.5V
- Fixed Output Voltage from 1V to 3.3V
- Ultra Low Dropout Voltage: 450mV @1A
- Low Shutdown Current < 1uA
- Only 4.7uF Ceramic Capacitor required for stability
- Over Temperature Protection
- Current Limit Protection
- RoHS Compliant and 100% Lead (Pb)-Free

## Applications

- Cellular Handsets
- Battery-Powered Equipment
- Laptop, Palmtops, Notebook Computers
- Hand-Held Instruments
- PCMCIA Cards
- Portable Information Applications



## Pin Configuration

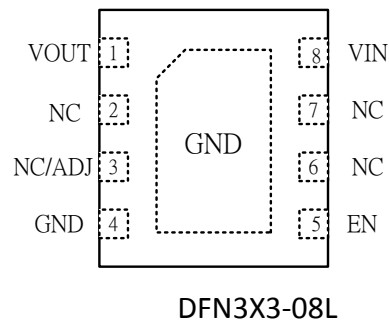

## Typical Application Circuit

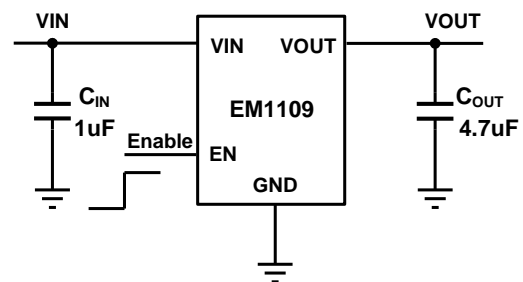

Fixed Version Output

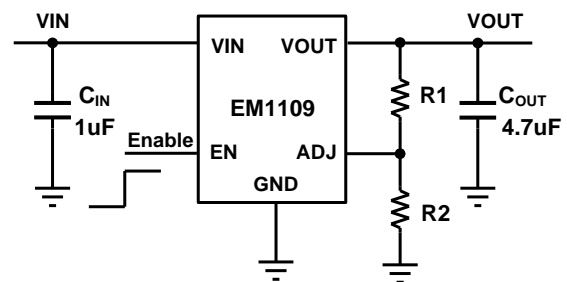

Adjustable Output

## Pin Assignment

Pin Name	Pin No DFN3X3-08L	Pin Function
VIN	8	<b>Input Voltage.</b> This is the source input to the power device that supplies current to the output pin.
GND	4	<b>Ground.</b>
EN	5	<b>Chip Enable Input (Active high).</b>
VOUT	1	<b>Output Voltage.</b> VOUT is power output pin. An internal pull low resistance exists when the device is disabled. Minimum 4.7uF low ESR ceramic capacitor is required at this pin for stabilizing VOUT voltage.
NC	2,6,7	<b>No Connection.</b>
NC/ADJ	3	<b>Feedback.</b> Error amplifier input. This pin should be connected to external resistive divider from output voltage.

## Function Block Diagram

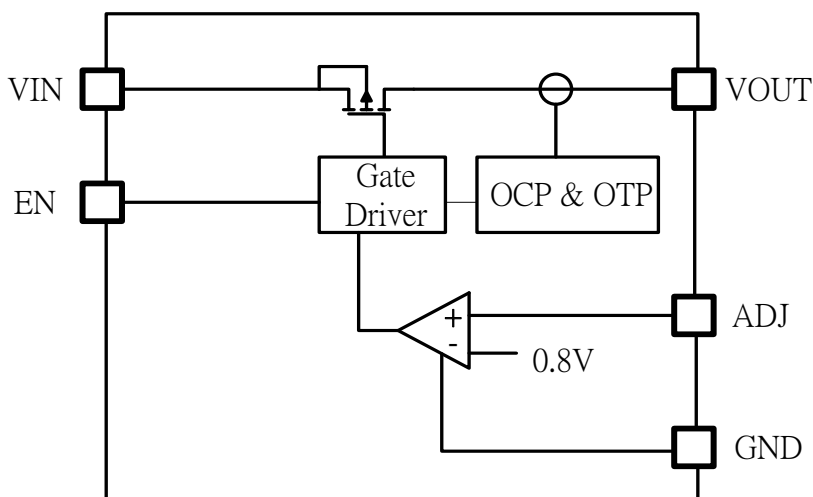
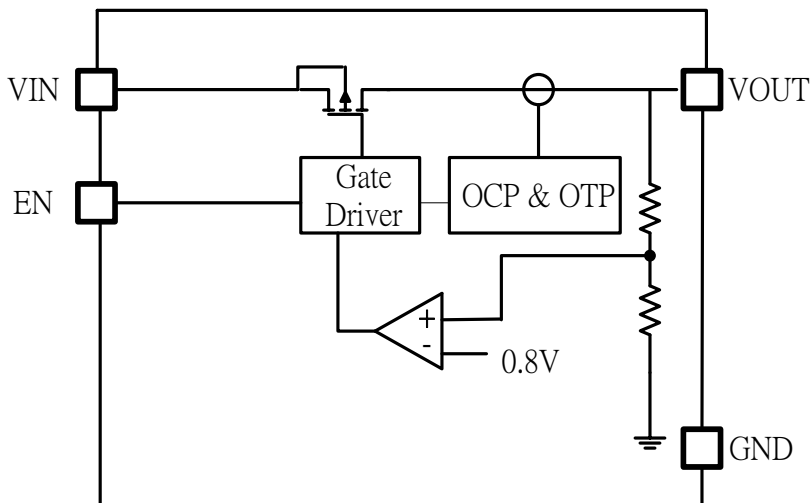

### Absolute Maximum Ratings (Note1)

● $V_{IN}$ -----	-0.3V to +6.0V
● Other Pins -----	6V
● Power Dissipation, $P_D$ @ $T_A = 25^\circ\text{C}$ , DFN3X3-08L -----	1.7W
● Package Thermal Resistance, $\theta_{JA}$ , DFN3X3-08L (Note 2) -----	70°C/W
● Package Thermal Resistance, $\theta_{JC}$ , DFN3X3-08L (Note 2) -----	5°C/W
● Junction Temperature -----	150°C
● Lead Temperature (Soldering, 10 sec.) -----	260°C
● Storage Temperature Range -----	-65°C to 150°C
● ESD susceptibility (Note3)	
HBM (Human Body Mode) -----	2KV
MM (Machine Mode) -----	200V

### Recommended Operating Conditions (Note4)

● Supply Input Voltage, $V_{IN}$ -----	+2.5 to +5.5V
● Junction Temperature -----	-40°C to 125°C
● Ambient Temperature -----	-40°C to 85°C

**Electrical Characteristics**
 $V_{IN}=V_{OUT}+1V$ ,  $T_A=25^{\circ}C$ , unless otherwise specified

Parameter	Symbol	Test Conditions	Min	Typ	Max	Units
Reference Voltage	$V_{REF}$	$V_{OUT}=V_{REF}$ , $I_{OUT}=1mA$	0.788	0.8	0.812	V
Feedback Leakage Current	$I_{ADJ}$	-	-	0.1	0.5	$\mu A$
Power Input Voltage	$V_{IN}$	$I_{OUT}=0$ to 1A	2.5	-	5.5	V
Output Voltage	$V_{OUT}$	$I_{OUT}=0$ to 1A	$>V_{REF}$	-	5	V
POR Threshold	$V_{PORTH}$	$I_{OUT}=0$ to 1A	-	2.1	2.4	V
POR Hysteresis	$V_{PORHYS}$	$I_{OUT}=0$ to 1A	-	0.2	-	V
Quiescent Current	$I_Q$	$V_{IN}=V_{EN}=5V$ , $I_{OUT}=0A$	-	80	-	$\mu A$
Shutdown Current	$I_{SD}$	$V_{IN}=5V$ , $V_{EN}=0V$	-	0.1	1	$\mu A$
Output Voltage Accuracy	$V_{OUT}$	$I_{OUT}=1mA$	-1.5	-	1.5	%
Line Regulation	$V_{OUT(LINE)}$	$2.5V < V_{IN} < 5.5V$ , $I_{OUT}=1mA$	-	-	0.2	%/V
Load Regulation	$V_{OUT(LOAD)}$	$1mA < I_{OUT} < 1A$ , $V_{IN}=V_{OUT}+0.5V$	-	0.5	1	%/A
Power Supply Rejection Ratio	PSRR	$I_{OUT}=10mA, 1kHz$	-	70	-	dB
		$I_{OUT}=10mA, 10kHz$	-	60	-	
		$I_{OUT}=10mA, 100kHz$	-	40	-	
Dropout Voltage ( $I_{OUT}=300mA$ )	$V_{DROP}$	$2V \leq V_{OUT} \leq 2.5V$	-	200	250	mV
		$2.6V \leq V_{OUT} \leq 3.5V$	-	100	150	
Dropout Voltage ( $I_{OUT}=1A$ )	$V_{DROP}$	$2V \leq V_{OUT} \leq 2.5V$	-	450	-	mV
		$2.6V \leq V_{OUT} \leq 3.5V$	-	360	-	
Enable High Level	$V_{EN}$	-	1.2	-	-	V
Disable Low Level	$V_{SD}$	-	-	-	0.3	V
Enable Input Current	$I_{EN}$	$V_{EN}=5V$ or $0V$	-1	-	1	$\mu A$
Output Voltage Ramp Up Time		$C_{OUT}=1\mu F$ , $V_{OUT}=V_{REF}$	-	200	-	$\mu s$
OCP Threshold Level	$I_{OCP}$	-	1.1			A
Thermal Shutdown Temperature	$T_{SD}$	$V_{IN}=V_{EN}=5V$ , $V_{OUT}=V_{REF}$ , $I_{OUT}=0A$	-	160	-	$^{\circ}C$
Thermal Shutdown Hysteresis	$T_{SDHYS}$	$V_{IN}=V_{EN}=5V$ , $V_{OUT}=V_{REF}$ , $I_{OUT}=0A$	-	30	-	$^{\circ}C$

**Note 1.** Stresses listed as the above "Absolute Maximum Ratings" may cause permanent damage to the device. These are for stress ratings. Functional operation of the device at these or any other conditions beyond those indicated in the operational sections of the specifications is not implied. Exposure to absolute maximum rating conditions for extended periods may remain possibility to affect device reliability.

**Note 2.**  $\theta_{JA}$  is measured in the natural convection at  $T_A=25^{\circ}C$  on a low effective thermal conductivity test board (2Layer PCB) of JEDEC 51-3 thermal measurement standard.

**Note 3.** Devices are ESD sensitive. Handling precaution is recommended.

**Note 4.** The device is not guaranteed to function outside its operating conditions.

**Note 5.** EMC will review datasheet by quarter, and update new version.



Typical Operating Characteristics

START UP Time (Power On From  $V_{IN}$ )

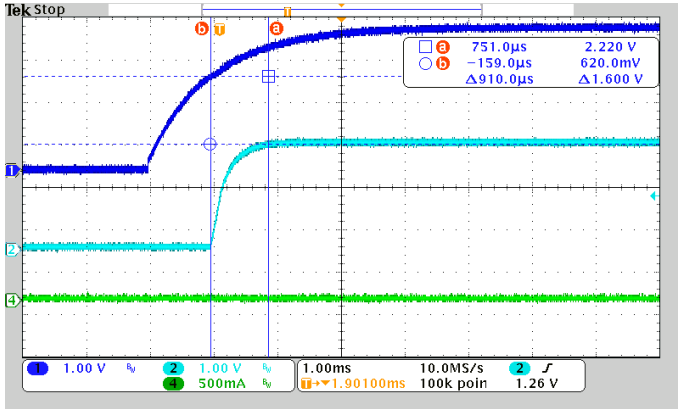

CH1: $V_{IN}$ , CH2: $V_{OUT}$ , CH4: $I_{OUT}$   
 $V_{IN}=3.3V$ ,  $V_{OUT}=2.5V$ ,  $I_{OUT}=0A$

START UP Time (Power On From  $V_{IN}$ )

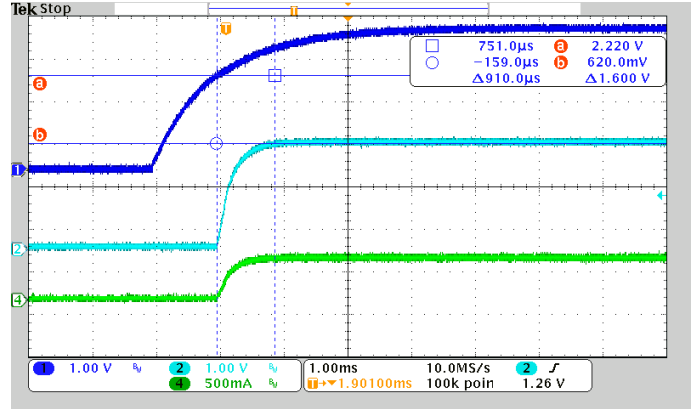

CH1: $V_{IN}$ , CH2: $V_{OUT}$ , CH4: $I_{OUT}$   
 $V_{IN}=3.3V$ ,  $V_{OUT}=2.5V$ ,  $I_{OUT}=500mA$

START UP Time (Power On From  $V_{EN}$ )

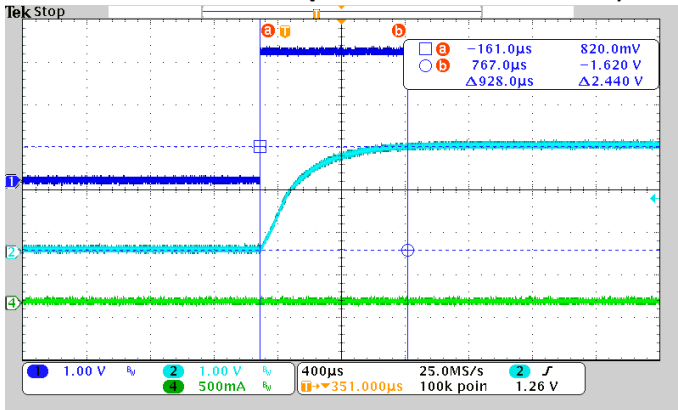

CH1: $V_{EN}$ , CH2: $V_{OUT}$ , CH4: $I_{OUT}$   
 $V_{IN}=3.3V$ ,  $V_{OUT}=2.5V$ ,  $I_{OUT}=0A$

START UP Time (Power On From  $V_{EN}$ )

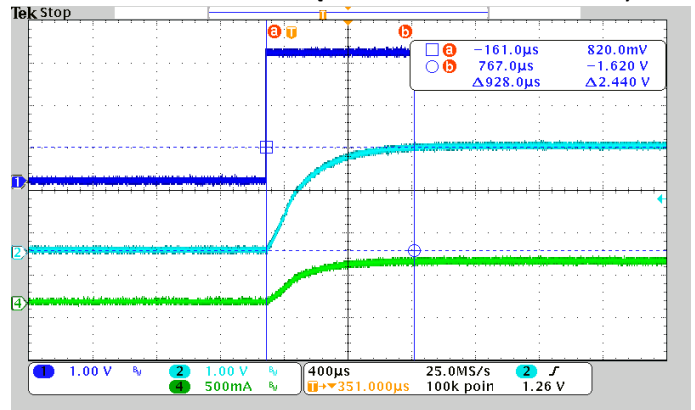

CH1: $V_{EN}$ , CH2: $V_{OUT}$ , CH4: $I_{OUT}$   
 $V_{IN}=3.3V$ ,  $V_{OUT}=2.5V$ ,  $I_{OUT}=500mA$

Line Transient Response ( $V_{OUT}=1.2V$ )

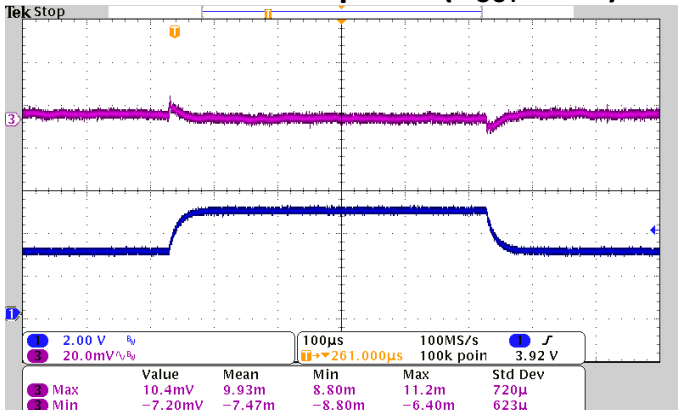

CH1: $V_{IN}$ , CH3: $V_{OUT}$   
 $V_{IN}=2.5\sim 5V$ ,  $I_{OUT}=100mA$

Line Transient Response ( $V_{OUT}=2.5V$ )

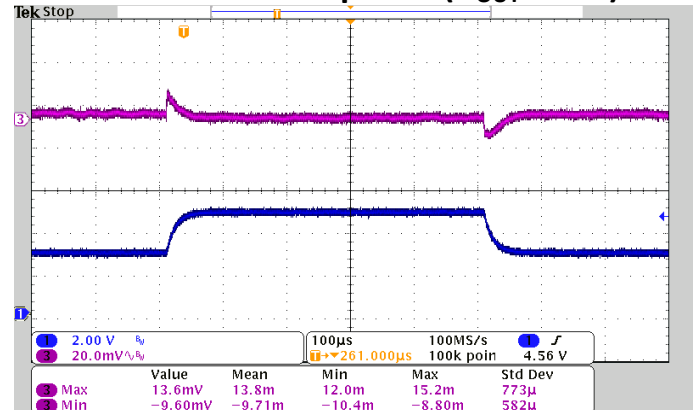

CH1: $V_{IN}$ , CH3: $V_{OUT}$   
 $V_{IN}=2.5\sim 5V$ ,  $I_{OUT}=100mA$



Line Transient Response ( $V_{OUT}=3.3V$ )

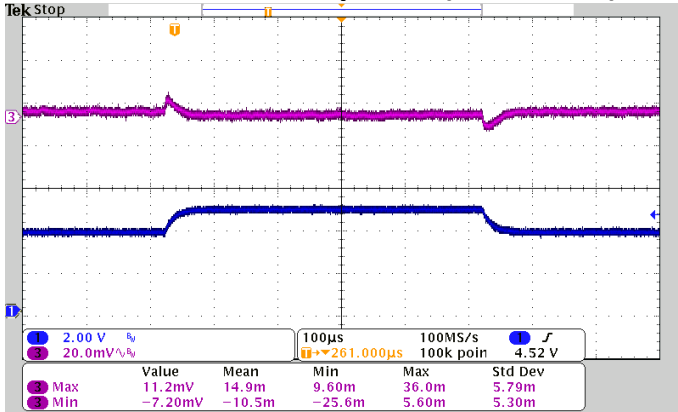

CH1: $V_{IN}$ , CH3: $V_{OUT}$   
 $V_{IN}=2.5\sim 5V$ ,  $I_{OUT}=100mA$

Load Transient Response ( $V_{OUT}=1.2V$ )

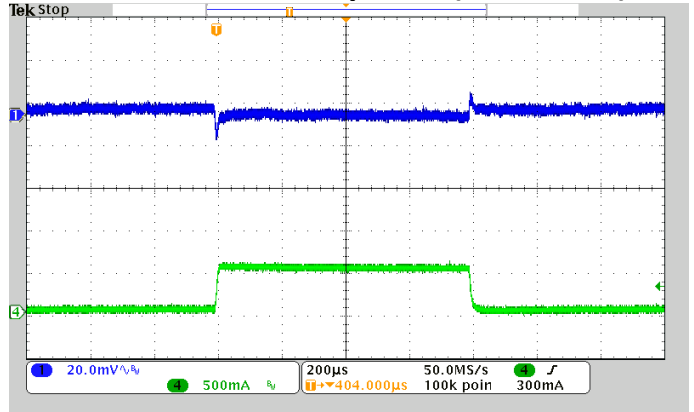

CH1: $V_{OUT}$ , CH4: $I_{OUT}$   
 $V_{IN}=2.5V$ ,  $I_{OUT}=10mA\sim 500mA$

Load Transient Response ( $V_{OUT}=2.5V$ )

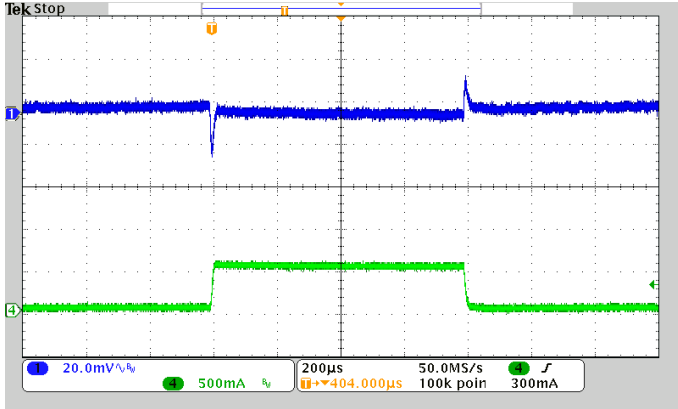

CH1: $V_{OUT}$ , CH4: $I_{OUT}$   
 $V_{IN}=3.5V$ ,  $I_{OUT}=10mA\sim 500mA$

Load Transient Response ( $V_{OUT}=3.3V$ )

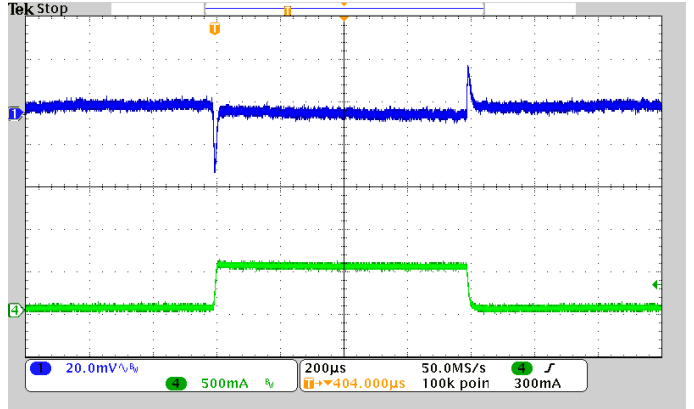

CH1: $V_{OUT}$ , CH4: $I_{OUT}$   
 $V_{IN}=4.3V$ ,  $I_{OUT}=10mA\sim 500mA$

Reference Voltage VS Temperature

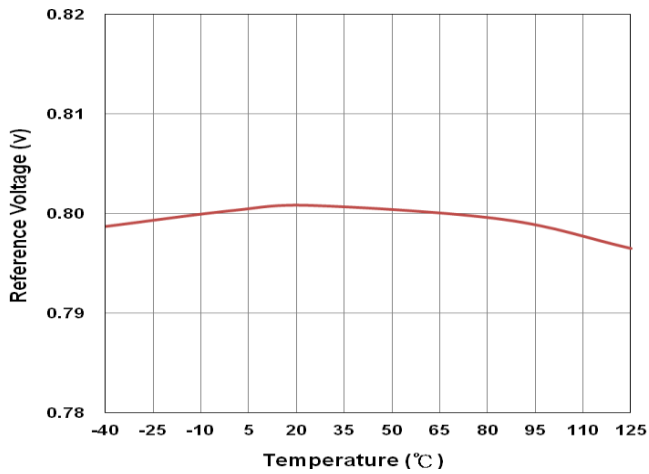

Current Limit VS Temperature

Dropout Voltage VS Output Current

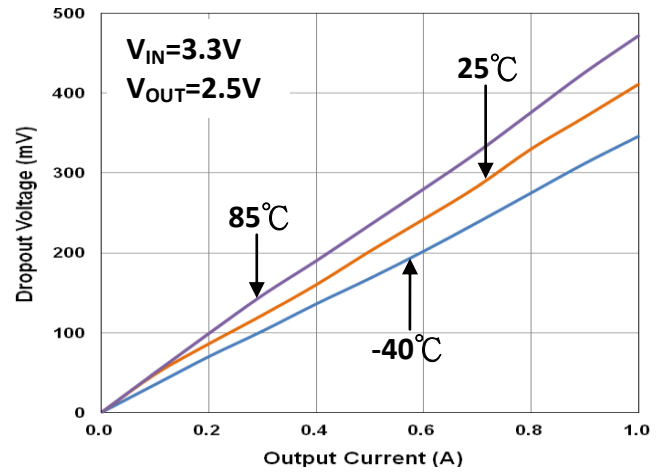

Quiescent Current VS Temperature

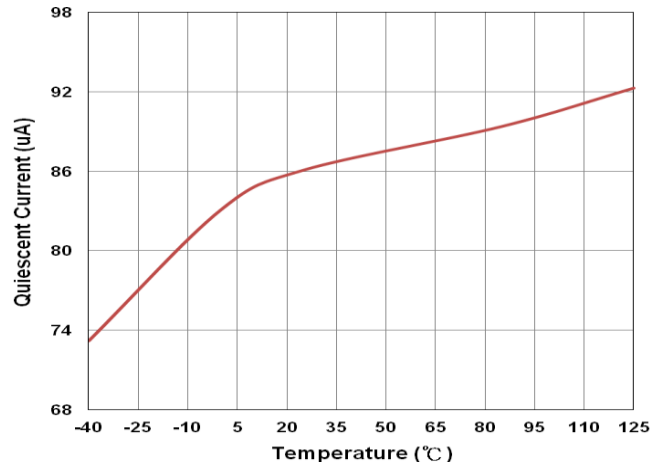
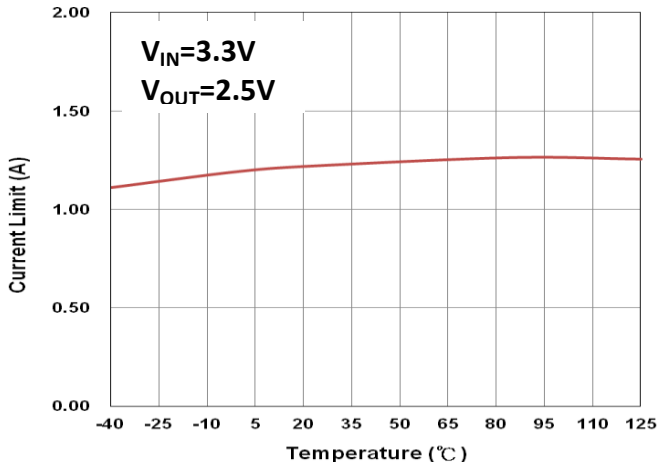

**Shutdown Current VS Temperature**

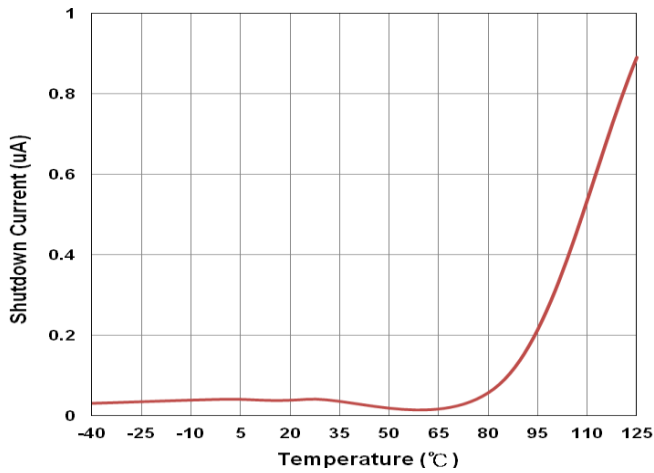

**Enable Threshold VS Temperature**

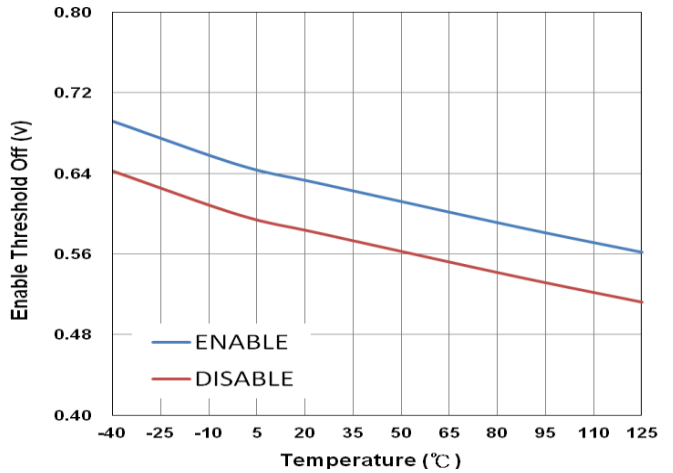

**Output Voltage VS Temperature**

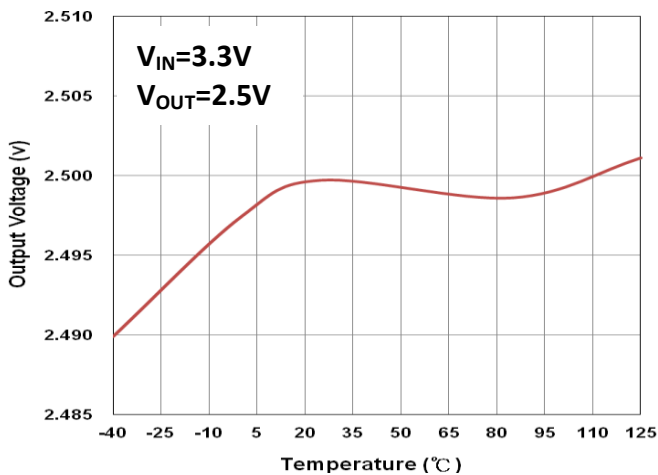

**Load Regulation ( $V_{OUT}$  VS  $I_{OUT}$ )**

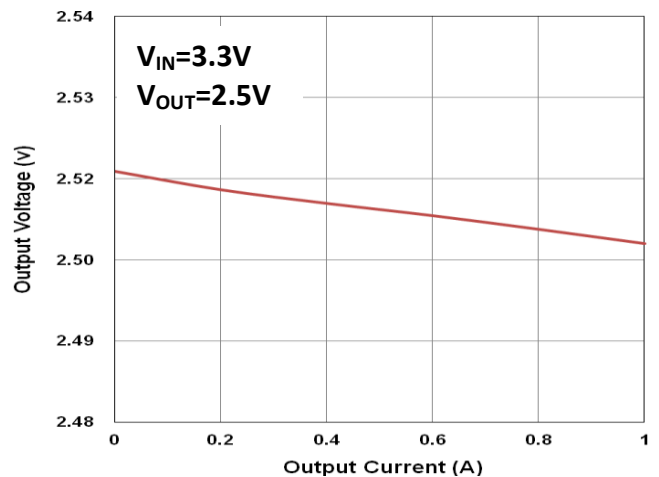



Line Regulation ( $V_{OUT}=1V$ )

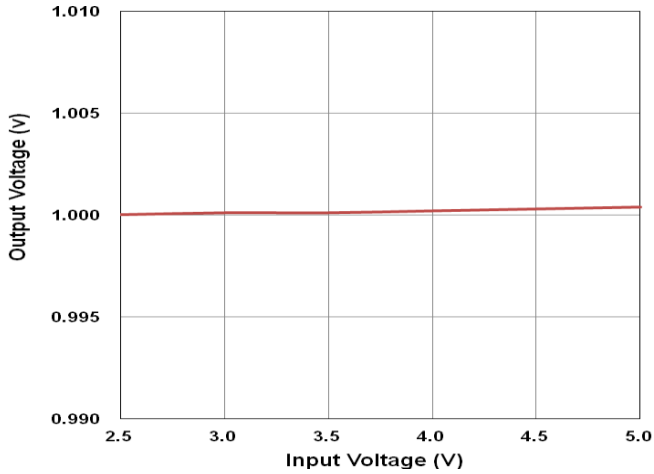

Line Regulation ( $V_{OUT}=1.5V$ )

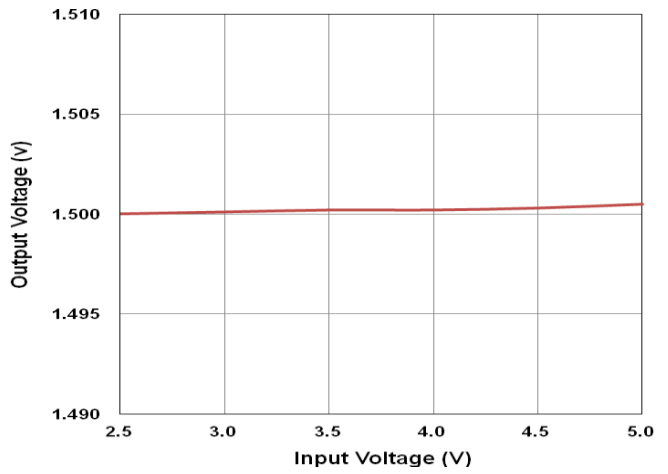

Line Regulation ( $V_{OUT}=2V$ )

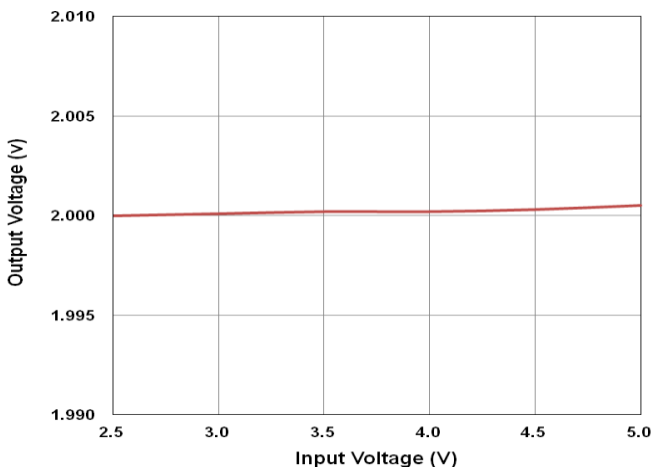

Line Regulation ( $V_{OUT}=2.5V$ )

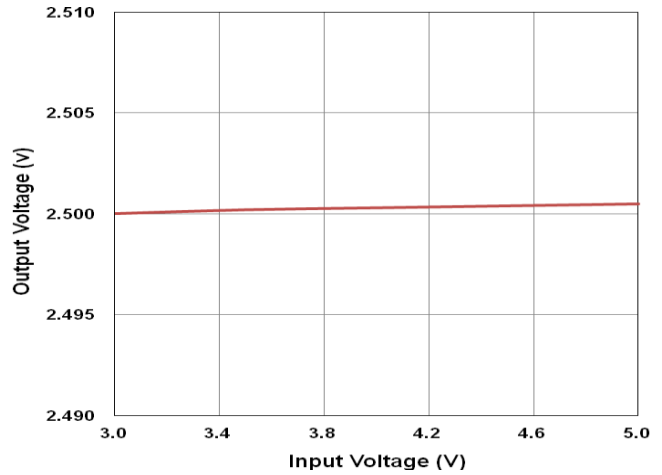

Line Regulation ( $V_{OUT}=3V$ )

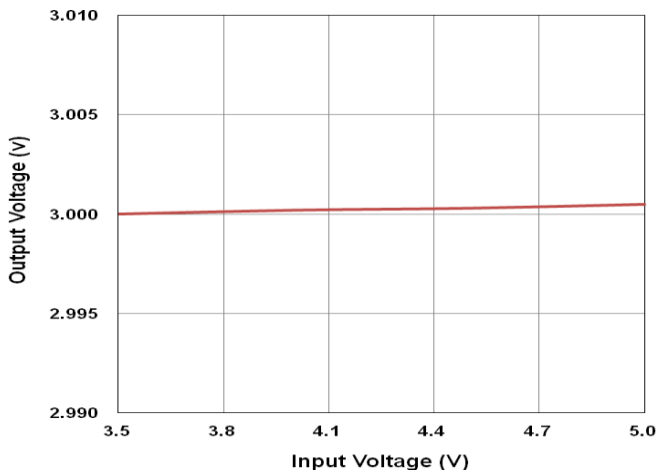

Line Regulation ( $V_{OUT}=3.5V$ )

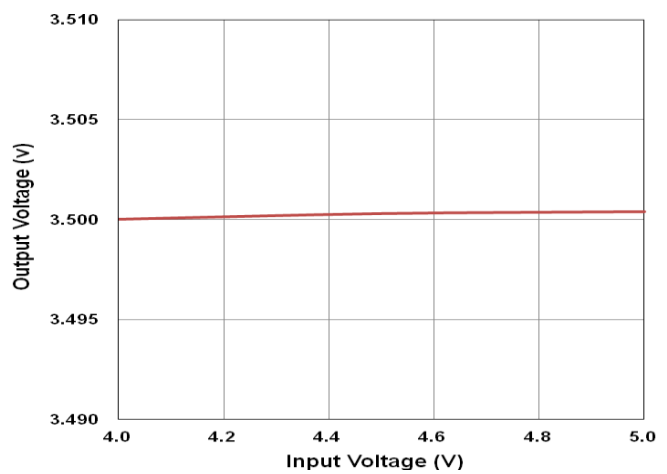



## Functional Description

### Enable Function

EM1109 is enabled if the voltage of the EN pin is greater than 1.4V. If the voltage of the EN pin is less than 0.38V, the IC will be disabled.

### POR – Power ON Reset

To let EM1109 start to operation, input voltage must be higher than its POR voltage even when EN voltage is pulled higher than enable high voltage. Typical POR voltage is 2.1V.

### Over Current Limit Function

EM1109 features over current limiting function which can limit its output current to 1.3A.

### Input and Output Capacitor Selection

For VIN pin, 1uF or larger ceramic capacitor is required to provide bypass path in transient current demand. VOUT pin is also recommended to have 4.7uF or larger ceramic capacitor to be stable and reduce the VOUT voltage dip when fast loading transient is happened.

### Thermal and Layout Consideration

EM1109 is designed to maintain a constant output load current. Due to physical limitations of the chip layout and assembly of the device the maximum switch current is 1A. All copper traces for the VIN and Vo pin should be widely and short to carry the maximum continuous current and obtain the best effect. The maximum IC junction temperature should be restricted to 125 °C under normal operating conditions. To calculate the maximum allowable dissipation, PD(MAX) for a given output current and ambient temperature, used the following equation:

$$P_{D(MAX)} = \frac{T_{J(MAX)} - T_A}{\theta_{JA}}$$

Where:

PD(MAX)=Maximum allowable power dissipation

TJ(MAX)=Maximum allowable junction temperature (125 °C for the EM1109)

TA=Ambient Temperature of the device

## Output Voltage Setting

The EM1109 output voltage is programmed using an external resistor divider as shown in below Figure.

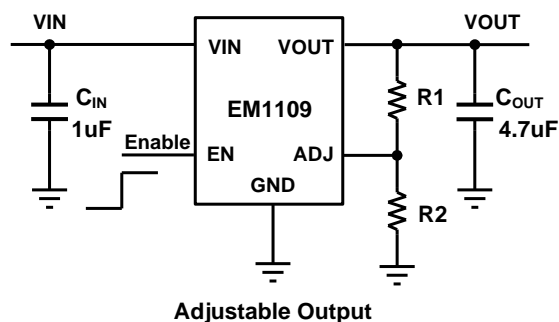

The output voltage is calculated using below Equation :

$$V_{OUT} = 0.8V \times \left( \frac{R1}{R2} + 1 \right)$$

**Ordering & Marking Information**

Device Name: EM1109V for DFN 3X3-08L

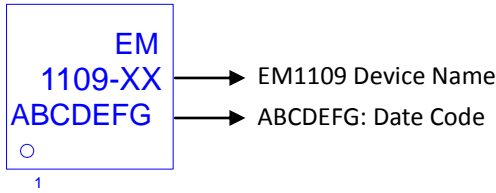

XX	output Voltage
AD	Adjust
10	1.0V
12	1.2V
15	1.5V
18	1.8V
25	2.5V
30	3.0V
33	3.3V

**Outline Drawing**

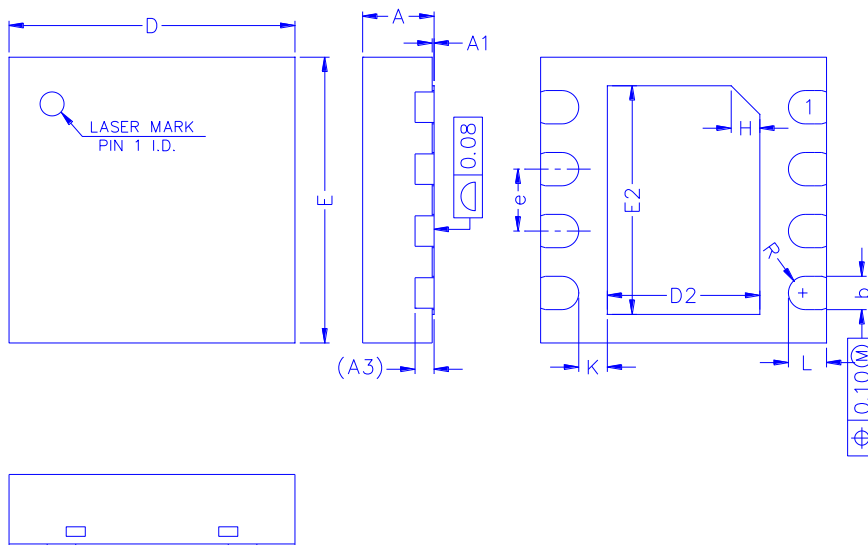

Dimension in mm

Dimension	A	A1	A3	b	D	E	D2	E2	e	H	K	L	R
Min.	0.7	0.00	0.2 REF	0.3	2.9	2.9	1.5	2.3	0.55	0.3REF	0.2	0.3	0.16
Typ.	0.75	0.02		0.35	3.0	3.0	1.6	2.4	0.65		0.3	0.4	
Max.	0.8	0.05		0.4	3.1	3.1	1.7	2.5	0.75		0.4	0.5	

Recommended minimum pads

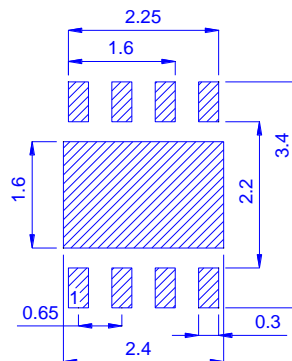

◆ Tape&Reel Information: 3000pcs/Reel

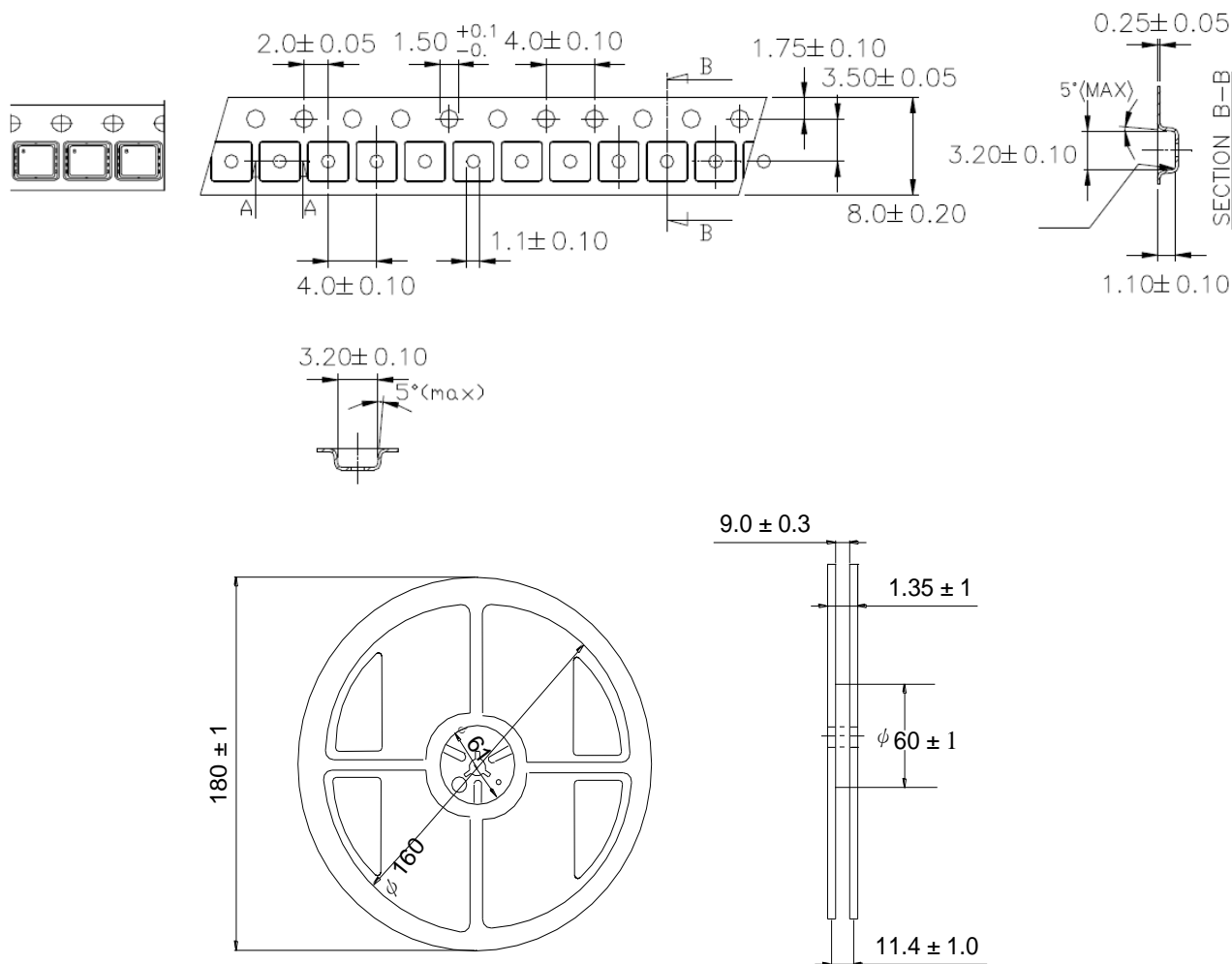

產品別	DFN 3X3-08L ( EM1109V )
Reel 尺寸	7"
編帶方式	
前空格	50
後空格	50
裝箱數	
滿捲數量	3K
捲/內盒比	5 : 1
內盒滿箱數	15K
內/外箱比	12 : 1
外箱滿箱數	180K