

XBF10A60S-G

ETR42003-002

1.0A Fast Recovery Rectifier

FEATURES

- Forward Current : $I_{F(AV)}=1.0A$
- Reverse Recovery Time : $t_{rr}=35ns$ (TYP.)
- Environmentally Friendly : EU RoHS Compliant

APPLICATIONS

- LED lighting
- Power supply module
- AC adapter, Battery charger

MARKING

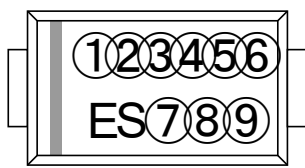

①②③④⑤⑥ : Control Number
⑦⑧⑨ : Marking Code



PACKAGING INFORMATION

● SMAF

Unit : inch (mm)

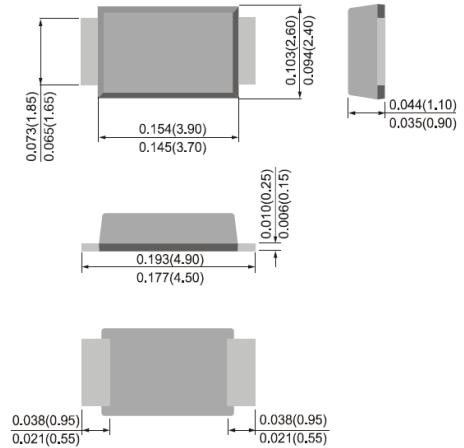

ABSOLUTE MAXIMUM RATINGS

$T_a=25^{\circ}C$

PARAMETER	SYMBOL	RATINGS	UNITS
Repetitive Peak Reverse Voltage	V_{RM}	600	V
RMS Voltage	V_{RMS}	420	V
Reverse Voltage (DC)	V_R	600	V
Forward Current (Average)	$I_{F(AV)}$	1	A
Non Continuous Forward Surge Current ^(*)	I_{FSM}	30	A
Junction Temperature	T_j	150	$^{\circ}C$
Storage Temperature	T_{stg}	-55~ +150	$^{\circ}C$

^(*) 60Hz single half sine wave

ELECTRICAL CHARACTERISTICS

$T_a=25^{\circ}C$

PARAMETER	SYMBOL	TEST CONDITIONS	LIMITS			UNITS
			MIN.	TYP.	MAX.	
Forward Voltage	V_F	$I_F=1A$, Pulse measurement	-	-	1.7	V
Reverse Current	I_R	$V_R=V_{RM}$	-	-	1	μA
Terminal Capacitance	C_t	$V_R=4V$, $f=1MHz$	-	15	-	pF
Reverse Recovery Time	t_{rr}	$I_F=0.5A$, $I_R=1A$, $i_{rr}=0.25A$	-	-	35	ns

■ PRODUCT NAME

PRODUCT NAME	PACKAGE	ORDER UNIT	MARKING CODE
XBF10A60S-G *	SMAF	3,000pcs / Reel	1JF

* The "-G" suffix denotes Halogen and Antimony free as well as being fully EU RoHS compliant.

* However, the product uses high-melting-point solder paste and lead glass, both of which are not compliant with EU RoHS.

■ NOTES ON USE

1. Please use this IC within the absolute maximum ratings.

Even within the ratings, in case of high load use continuously such as high temperature, high voltage, high current and thermal stress may cause reliability degradation of the IC.

2. Torex places an importance on improving our products and their reliability.

We request that users incorporate fail-safe designs and post-aging protection treatment when using Torex products in their systems.

■ REFERENCE PATTERN LAYOUT

● SMAF

Unit : inch (mm)

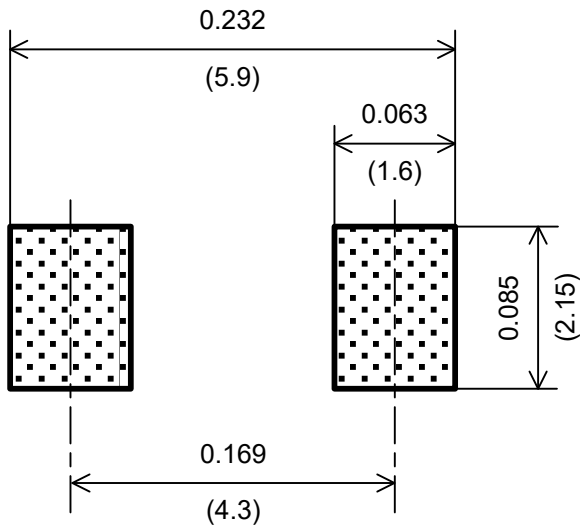

■ TYPICAL PERFORMANCE CHARACTERISTICS

(1) Forward Current vs. Forward Voltage

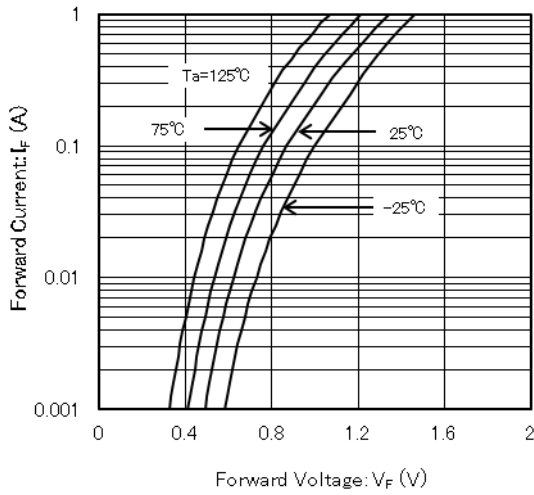

(2) Reverse Current vs. Reverse Voltage

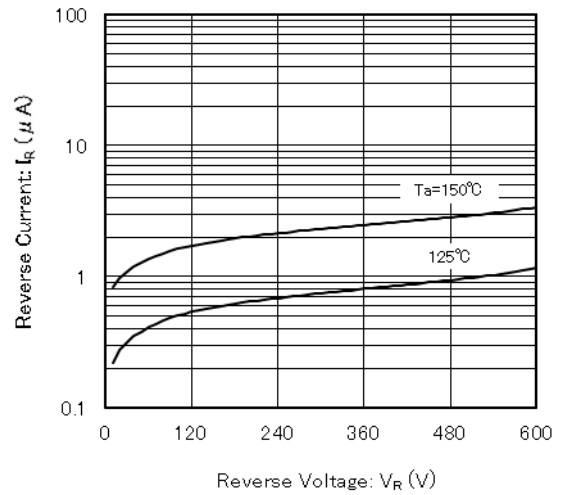

(3) Terminal Capacitance vs. Reverse Voltage

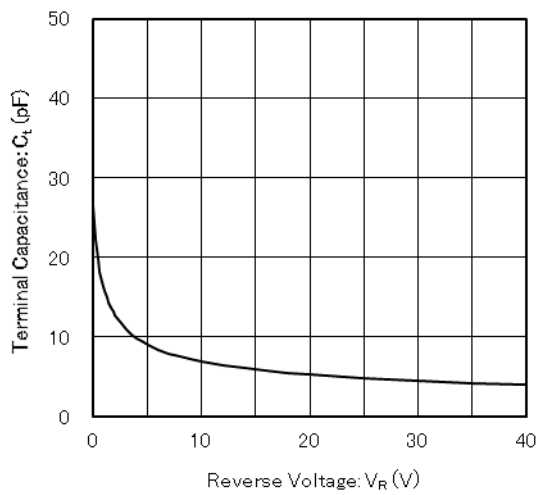

(4) Average Forward Current vs. Operating Temperature

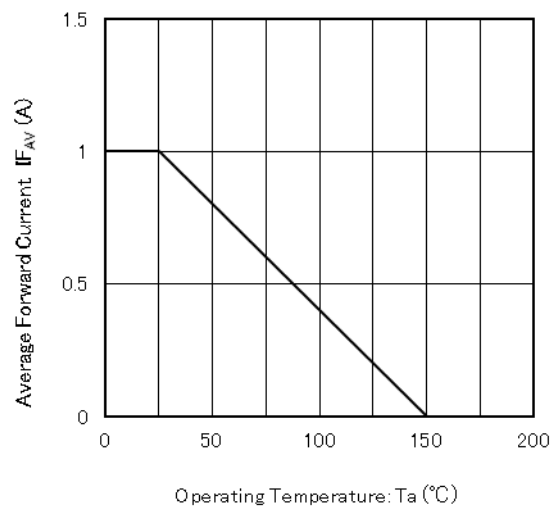

TAPING SPECIFICATIONS

●SMAF

Unit : mm

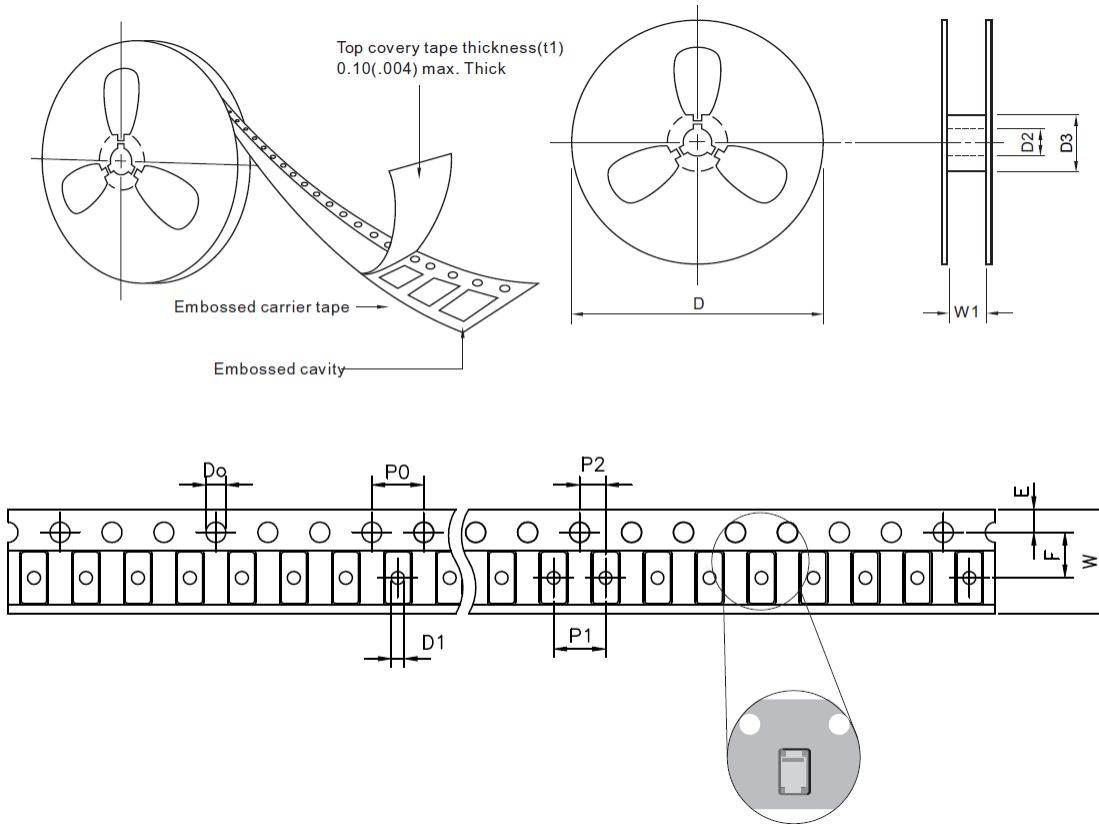

SYMBOL	mm
D ₀	1.55 ± 0.05
D ₁	1.00 ± 0.05
E	1.75 ± 0.10
F	5.50 ± 0.10
P ₀	4.00 ± 0.10
P ₁	4.00 ± 0.10
P ₂	2.00 ± 0.05
W	12.0 ± 0.3
D ₂	13.5 ± 0.5
D ₃	min. 57.0
W ₁	min. 13.7 , max. 16.7
D	178.0 ± 2.0

1. The product and product specifications contained herein are subject to change without notice to improve performance characteristics. Consult us, or our representatives before use, to confirm that the information in this datasheet is up to date.
2. The information in this datasheet is intended to illustrate the operation and characteristics of our products. We neither make warranties or representations with respect to the accuracy or completeness of the information contained in this datasheet nor grant any license to any intellectual property rights of ours or any third party concerning with the information in this datasheet.
3. Applicable export control laws and regulations should be complied and the procedures required by such laws and regulations should also be followed, when the product or any information contained in this datasheet is exported.
4. The product is neither intended nor warranted for use in equipment of systems which require extremely high levels of quality and/or reliability and/or a malfunction or failure which may cause loss of human life, bodily injury, serious property damage including but not limited to devices or equipment used in 1) nuclear facilities, 2) aerospace industry, 3) medical facilities, 4) automobile industry and other transportation industry and 5) safety devices and safety equipment to control combustions and explosions. Do not use the product for the above use unless agreed by us in writing in advance.
5. Although we make continuous efforts to improve the quality and reliability of our products; nevertheless Semiconductors are likely to fail with a certain probability. So in order to prevent personal injury and/or property damage resulting from such failure, customers are required to incorporate adequate safety measures in their designs, such as system fail safes, redundancy and fire prevention features.
6. Our products are not designed to be Radiation-resistant.
7. Please use the product listed in this datasheet within the specified ranges.
8. We assume no responsibility for damage or loss due to abnormal use.
9. All rights reserved. No part of this datasheet may be copied or reproduced unless agreed by Torex Semiconductor Ltd in writing in advance.

TOREX SEMICONDUCTOR LTD.