

Standard Voltage Detectors ($V_{DF}=1.6V\sim 6.0V$)

■ GENERAL DESCRIPTION

The XE61C series is a highly precise, low power consumption voltage detector, manufactured using CMOS process and laser trimming technologies.

Detect voltage is extremely accurate with minimal temperature drift.

Both CMOS and N-ch open drain output configurations are available.

The XE61C assures all temperature range ($T_a = -40^{\circ}C \sim +85^{\circ}C$).

■ APPLICATIONS

- Microprocessor reset circuitry
- Memory battery back-up circuits
- Power-on reset circuits
- Power failure detection
- System battery life and charge voltage monitors

■ FEATURES

- Detect Voltage Accuracy** : $\pm 2\%$ ($T_a=25^{\circ}C$)
: $\pm 4\%$ ($T_a=-40^{\circ}C\sim +85^{\circ}C$)
- Detect Voltage** : 1.6V~6.0V (0.1V increments)
- Temperature Characteristics** : $\pm 400\text{ppm}/^{\circ}C$ ($T_a=-40^{\circ}C\sim +85^{\circ}C$)
- Operating Voltage Range** : 0.7V~10.0V
- Low Power Consumption** : $0.7\mu A$ TYP. ($V_{IN}=1.5V$)
- Output Configuration** : N-ch open drain output or CMOS
- Packages** : SOT-23
: SOT-89
- Environmentally Friendly** : EU RoHS Compliant, Pb Free

■ TYPICAL APPLICATION CIRCUITS

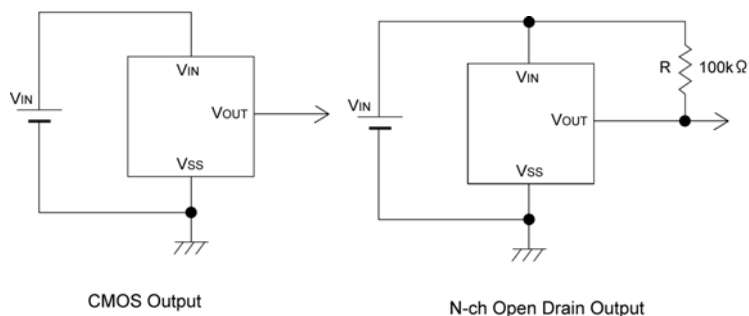

■ TYPICAL PERFORMANCE CHARACTERISTICS

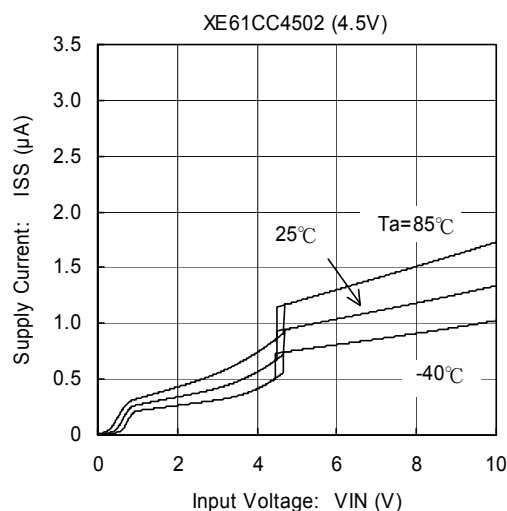

■ PIN CONFIGURATION

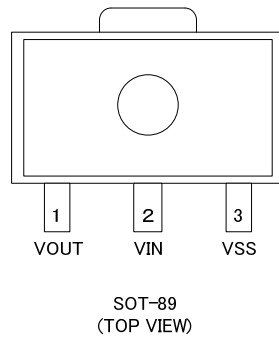
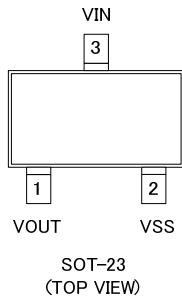

■ PIN ASSIGNMENT

| PIN NUMBER | | PIN NAME | FUNCTION |
|------------|--------|-----------|----------------------|
| SOT-23 | SOT-89 | | |
| 3 | 2 | V_{IN} | Supply Voltage Input |
| 2 | 3 | V_{SS} | Ground |
| 1 | 1 | V_{OUT} | Output |

■ PRODUCT CLASSIFICATION

● Ordering Information

XE61C①②③④⑤⑥⑦-⑧^(*)

| DESIGNATOR | ITEM | SYMBOL | DESCRIPTION |
|------------|--------------------------|---------|------------------------|
| ① | Output Configuration | C | CMOS output |
| | | N | N-ch open drain output |
| ②③ | Detect Voltage (VDF) | 16 ~ 60 | e.g.1.6V → ②1, ③6 |
| ④ | Output Delay | 0 | No delay |
| ⑤ | Detect Accuracy | 2 | Within $\pm 2\%$ |
| ⑥⑦-⑧ | Packages (Order Unit) | MR | SOT-23 (3,000/Reel) |
| | | MR-G | SOT-23 (3,000/Reel) |
| | | PR | SOT-89 (1,000/Reel) |

^(*) The "-G" suffix indicates that the products are Halogen and Antimony free as well as being fully RoHS compliant.

■ BLOCK DIAGRAMS

(1) CMOS Output

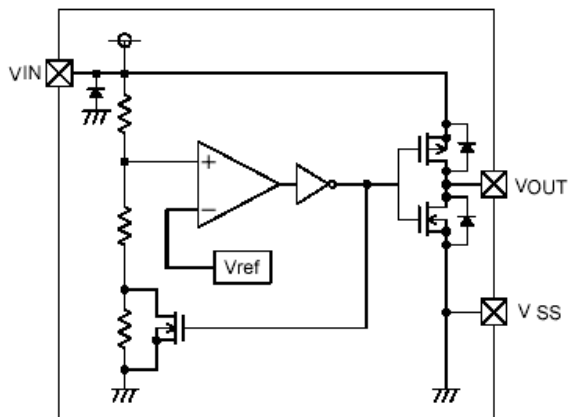

(2) N-ch Open Drain Output

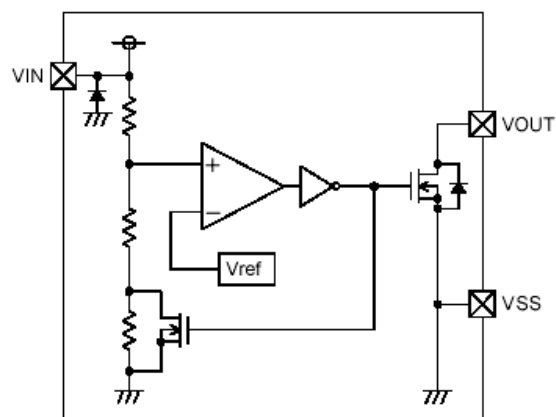

■ ABSOLUTE MAXIMUM RATINGS

Ta = 25°C

| PARAMETER | SYMBOL | RATINGS | UNITS |
|-----------------------------|------------------------|---|-------|
| Input Voltage | V _{IN} | V _{SS} -0.3~12.0 | V |
| Output Current | I _{OUT} | 50 | mA |
| Output Voltage | CMOS | V _{SS} -0.3 ~ V _{IN} +0.3 | V |
| | N-ch Open Drain Output | V _{SS} -0.3 ~ 12.0 | |
| Power Dissipation | SOT-23 | 250 | mW |
| | SOT-89 | 500 | |
| Operating Temperature Range | T _{opr} | - 40~+85 | °C |
| Storage Temperature Range | T _{stg} | -55~+125 | °C |

ELECTRICAL CHARACTERISTICS

XE61C Series

$V_{DF(T)}=1.6\sim 6.0V$, $T_a = -40^{\circ}C \sim 85^{\circ}C$

| PARAMETER | | SYMBOL | CONDITIONS | MIN. | TYP. | MAX. | UNITS | CIRCUITS | |
|---|------------------------|---|--|-------------------------|----------------------|-------------------------|------------------|----------|---|
| Detect Voltage | | V_{DF} | | $V_{DF(T)} \times 0.96$ | $V_{DF(T)}$ | $V_{DF(T)} \times 1.04$ | V | 1 | |
| Hysteresis Width | | V_{HYS} | | $V_{DF} \times 0.02$ | $V_{DF} \times 0.05$ | $V_{DF} \times 0.08$ | V | 1 | |
| Supply Current | | I_{SS} | $V_{IN} = 1.5V$ | - | 0.7 | 2.8 | μA | 2 | |
| | | | $V_{IN} = 2.0V$ | - | 0.8 | 3.3 | | | |
| | | | $V_{IN} = 3.0V$ | - | 0.9 | 3.5 | | | |
| | | | $V_{IN} = 4.0V$ | - | 1.0 | 3.7 | | | |
| | | | $V_{IN} = 5.0V$ | - | 1.1 | 3.9 | | | |
| Operating Voltage | | V_{IN} | $V_{DF(T)} = 1.6V \text{ to } 6.0V$ | 0.7 | - | 10.0 | V | 1 | |
| Output Current | | I_{OUT} | N-ch $V_{DS} = 0.5V$ | $V_{IN} = 1.0V$ | 0.4 | 2.2 | - | mA | 3 |
| | | | | $V_{IN} = 2.0V$ | 3.0 | 7.7 | - | | |
| | | | | $V_{IN} = 3.0V$ | 5.0 | 10.1 | - | | |
| | | | | $V_{IN} = 4.0V$ | 6.0 | 11.5 | - | | |
| | | | | $V_{IN} = 5.0V$ | 7.0 | 13.0 | - | | |
| | | | CMOS, P-ch $V_{DS} = 2.1V$, $V_{IN} = 8.0V$ | - | -10.0 | -2.0 | 4 | | |
| Leakage Current | CMOS Output (Pch) | I_{LEAK} | $V_{IN}=V_{DF} \times 0.9V, V_{OUT}=0V$ | - | -10 | - | nA | 3 | |
| | N-ch Open Drain Output | | $V_{IN}=10.0V, V_{OUT}=10.0V$ | - | 10 | 400 | | | |
| Temperature Characteristics | | $\Delta V_{DF} / (\Delta T_{opr} \cdot V_{DF})$ | $-40^{\circ}C \leq T_{opr} \leq 85^{\circ}C$ | - | ± 100 | ± 400 | ppm/ $^{\circ}C$ | 1 | |
| Delay Time (VDR \rightarrow VOUT inversion) | | t_{DLY} | Inverts from VDR to VOUT | - | 0.03 | 0.20 | ms | 5 | |

NOTE:

$V_{DF(T)}$: Nominal detect voltage

Release Voltage: $V_{DR} = V_{DF} + V_{HYS}$

■ OPERATIONAL EXPLANATION

(Especially explained for the CMOS output products)

- ① When input voltage (V_{IN}) is higher than detect voltage (V_{DF}), output voltage (V_{OUT}) will be equal to V_{IN} .
(A condition of high impedance exists with N-ch open drain output configurations.)
- ② When input voltage (V_{IN}) falls below detect voltage (V_{DF}), output voltage (V_{OUT}) will be equal to the ground voltage (V_{SS}) level.
- ③ When input voltage (V_{IN}) falls to a level below that of the minimum operating voltage (V_{MIN}), output will become unstable. (As for the N-ch open drain product of XC61CN, the pull-up voltage goes out at the output voltage.)
- ④ When input voltage (V_{IN}) rises above the ground voltage (V_{SS}) level, output will be unstable at levels below the minimum operating voltage (V_{MIN}). Between the V_{MIN} and detect release voltage (V_{DR}) levels, the ground voltage (V_{SS}) level will be maintained.
- ⑤ When input voltage (V_{IN}) rises above detect release voltage (V_{DR}), output voltage (V_{OUT}) will be equal to V_{IN} .
(A condition of high impedance exists with N-ch open drain output configurations.)
- ⑥ The difference between V_{DR} and V_{DF} represents the hysteresis range.

● Timing Chart

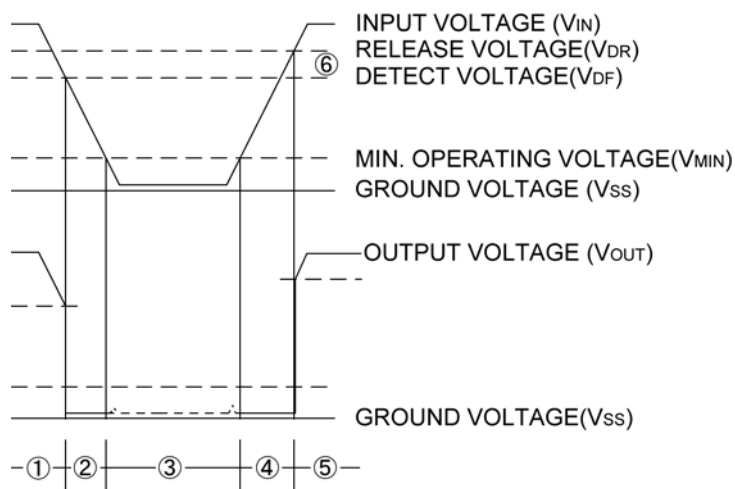

NOTES ON USE

1. Please use this IC within the stated absolute maximum ratings. For temporary, transitional voltage drop or voltage rising phenomenon, the IC is liable to malfunction should the ratings be exceeded.
2. When a resistor is connected between the V_{IN} pin and the power supply with CMOS output configurations, oscillation may occur as a result of voltage drops at R_{IN} if load current (I_{OUT}) exists. (refer to the Oscillation Description (1) below)
3. When a resistor is connected between the V_{IN} pin and the power supply with CMOS output configurations, irrespective of N-ch open-drain output configurations, oscillation may occur as a result of through current at the time of voltage release even if load current (I_{OUT}) does not exist. (refer to the Oscillation Description (2) below)
4. Please use N-ch open drain output configuration, when a resistor R_{IN} is connected between the V_{IN} pin and power source.
In such cases, please ensure that R_{IN} is less than $10k\Omega$ and that C is more than $0.1\mu F$, please test with the actual device. (refer to the Oscillation Description (1) below)
5. With a resistor R_{IN} connected between the V_{IN} pin and the power supply, the V_{IN} pin voltage will be getting lower than the power supply voltage as a result of the IC's supply current flowing through the V_{IN} pin.
6. In order to stabilize the IC's operations, please ensure that V_{IN} pin input frequency's rise and fall times are more than $2\mu s/V$.
7. Torex places an importance on improving our products and its reliability.
However, by any possibility, we would request user fail-safe design and post-aging treatment on system or equipment.

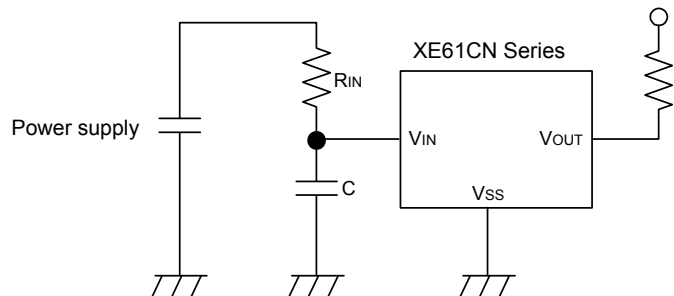

Figure 1: Circuit using an input resistor

Oscillation Description

(1) Load current oscillation with the CMOS output configuration

When the voltage applied at power supply, release operations commence and the detector's output voltage increases. Load current (I_{OUT}) will flow at R_L . Because a voltage drop ($R_{IN} \times I_{OUT}$) is produced at the R_{IN} resistor, located between the power supply and the V_{IN} pin, the load current will flow via the IC's V_{IN} pin. The voltage drop will also lead to a fall in the voltage level at the V_{IN} pin. When the V_{IN} pin voltage level falls below the detect voltage level, detect operations will commence. Following detect operations, load current flow will cease and since voltage drop at R_{IN} will disappear, the voltage level at the V_{IN} pin will rise and release operations will begin over again. Oscillation may occur with this " release - detect - release " repetition. Further, this condition will also appear via means of a similar mechanism during detect operations.

(2) Oscillation as a result of through current

Since the XE61C series are CMOS ICs, through current will flow when the IC's internal circuit switching operates (during release and detect operations). Consequently, oscillation is liable to occur as a result of drops in voltage at the through current's resistor (R_{IN}) during release voltage operations. (refer to Figure 3)
Since hysteresis exists during detect operations, oscillation is unlikely to occur.

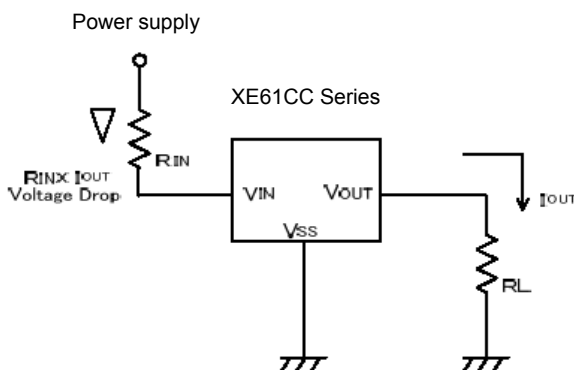

Figure 2: Oscillation in relation to output current

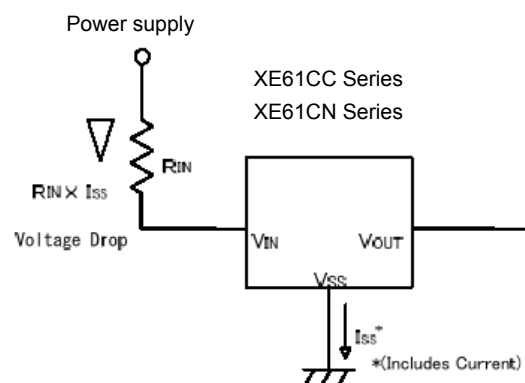
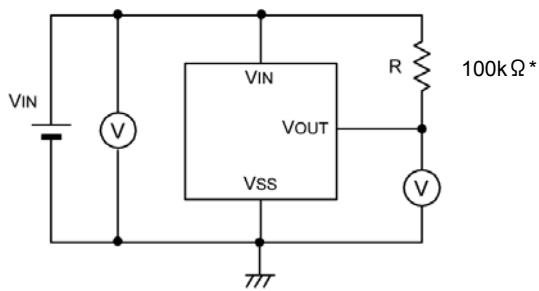

Figure 3: Oscillation in relation to through current

■ TEST CIRCUITS

Circuit 1



Circuit 2

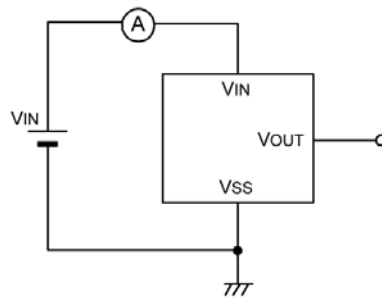

Circuit 3

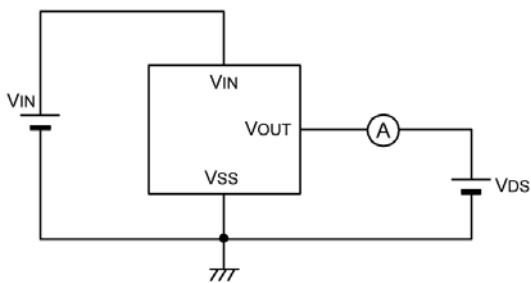

Circuit 4

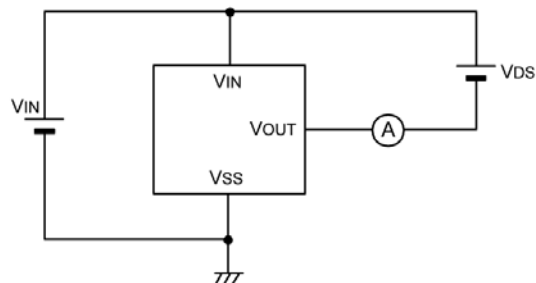

Circuit 5

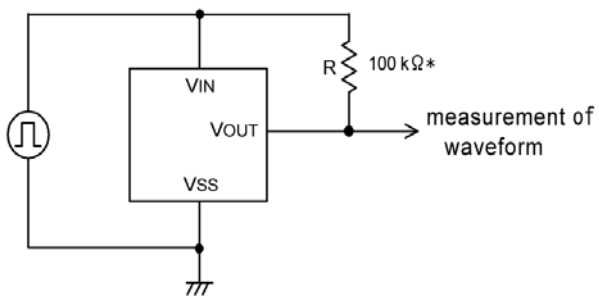

* : A resistor is not necessary with CMOS output products.

TYPICAL PERFORMANCE CHARACTERISTICS

(1) Supply Current vs. Input Voltage

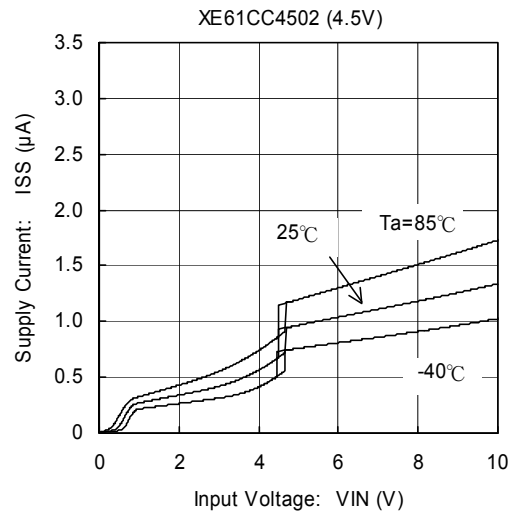
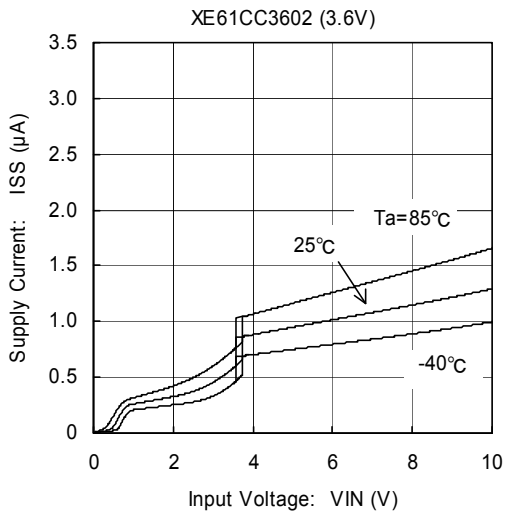
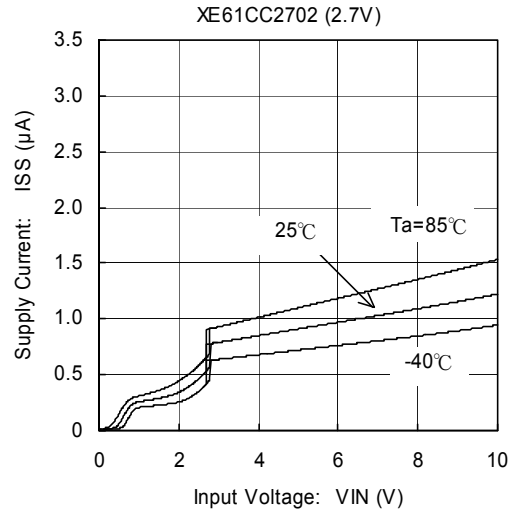
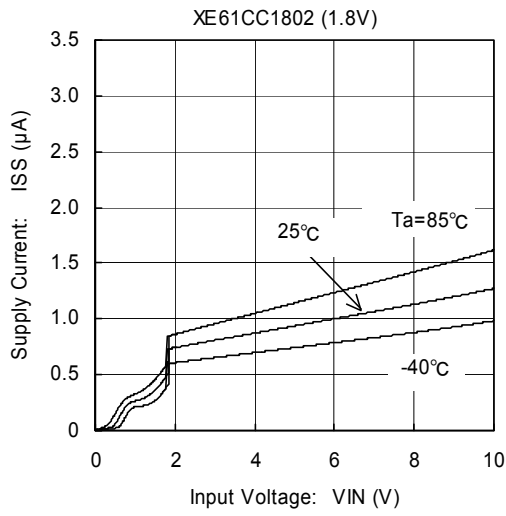

(2) Detect, Release Voltage vs. Ambient Temperature

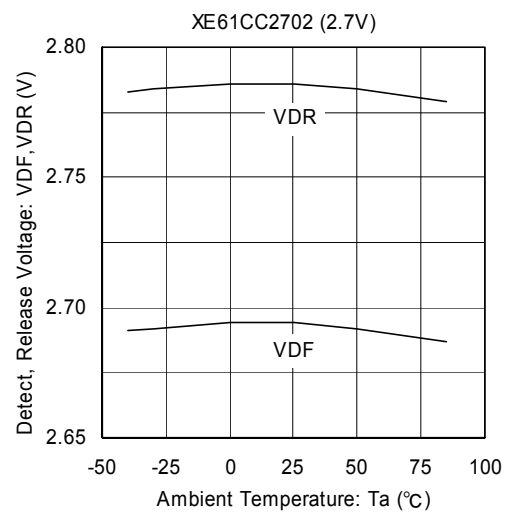
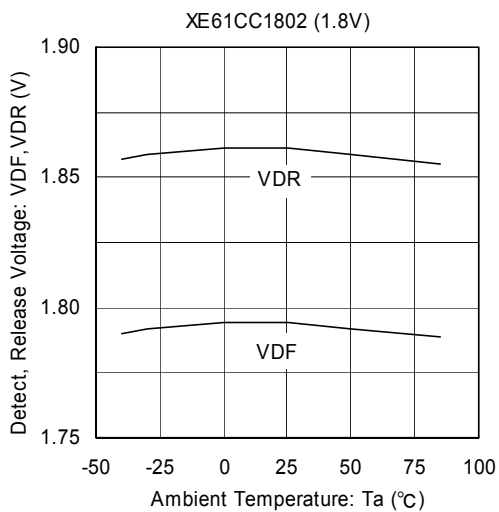

■ TYPICAL PERFORMANCE CHARACTERISTICS (Continued)

(2) Detect, Release Voltage vs. Ambient Temperature (Continued)

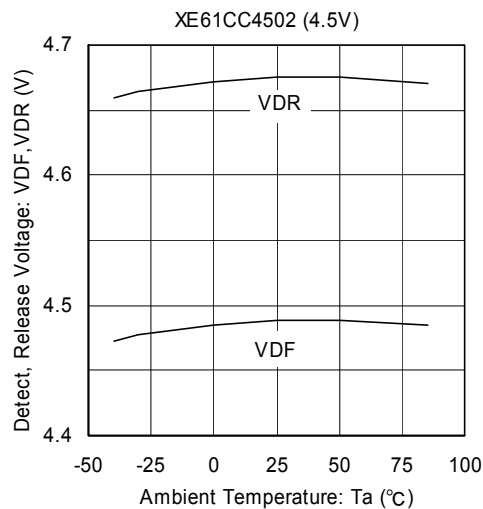
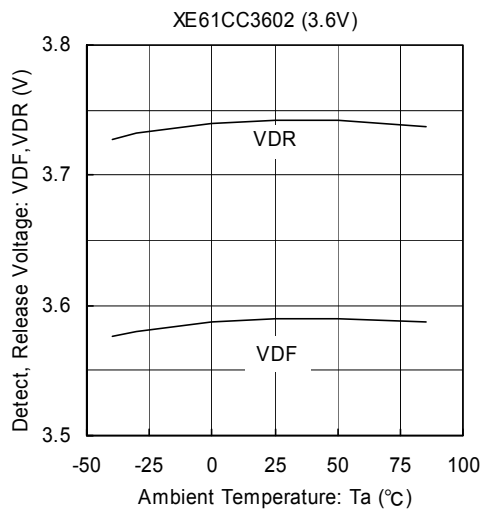

(3) Output Voltage vs. Input Voltage

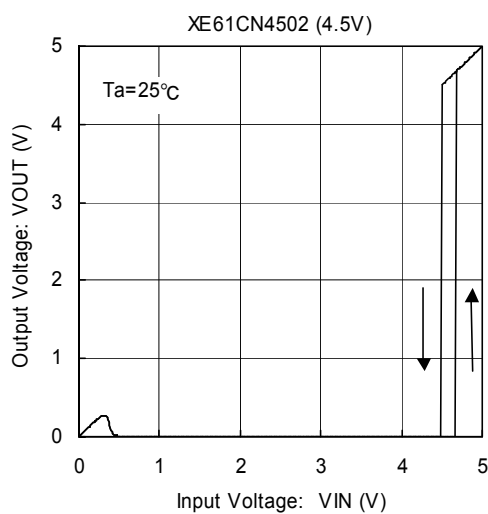
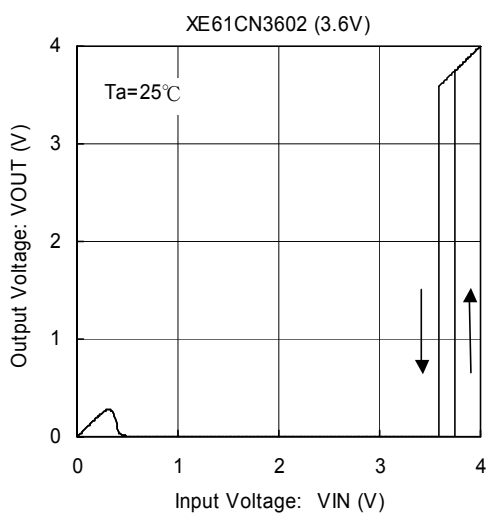
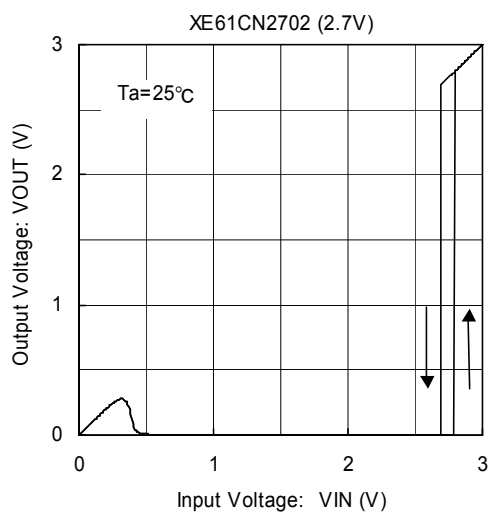
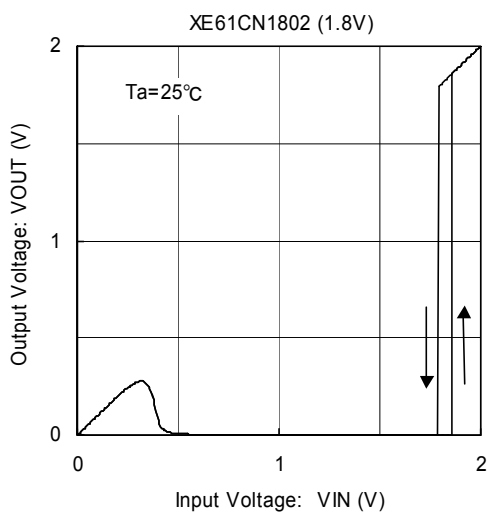

* Unless otherwise stated, the pull-up resistor's value of the N-ch open drain output type is 100kΩ.

TYPICAL PERFORMANCE CHARACTERISTICS (Continued)

(4) N-ch Driver Output Current vs. V_{DS} Characteristics

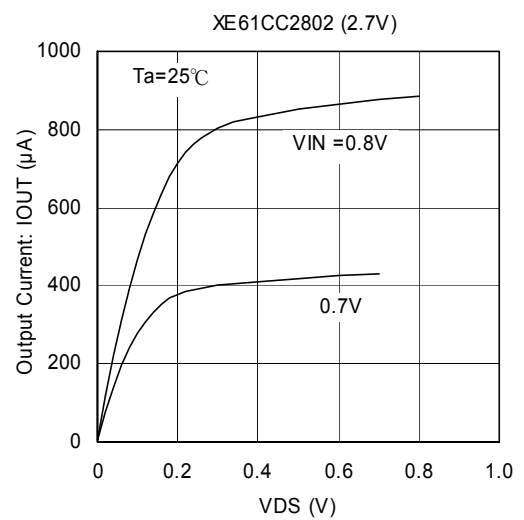
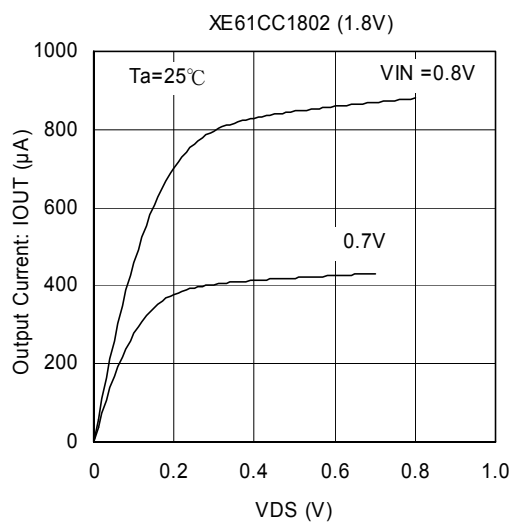
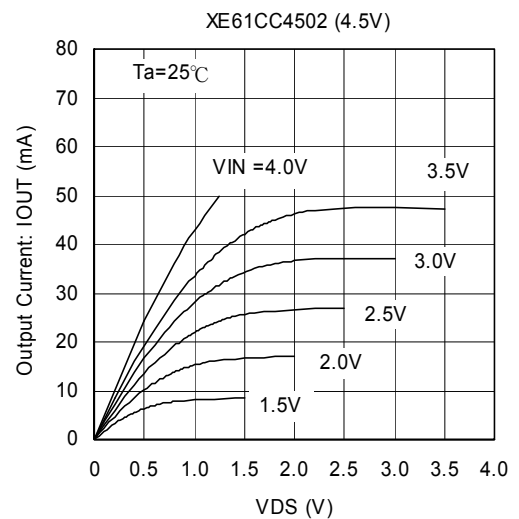
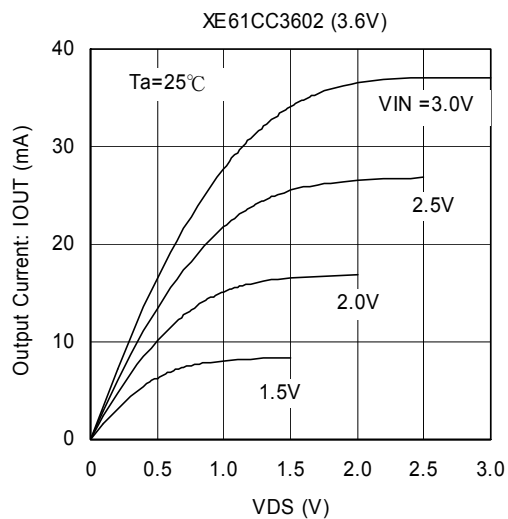
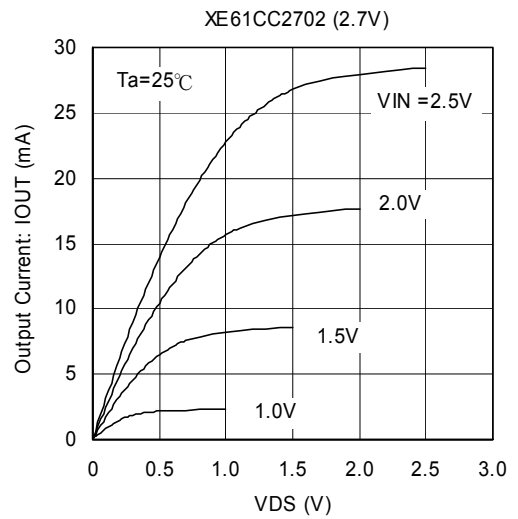
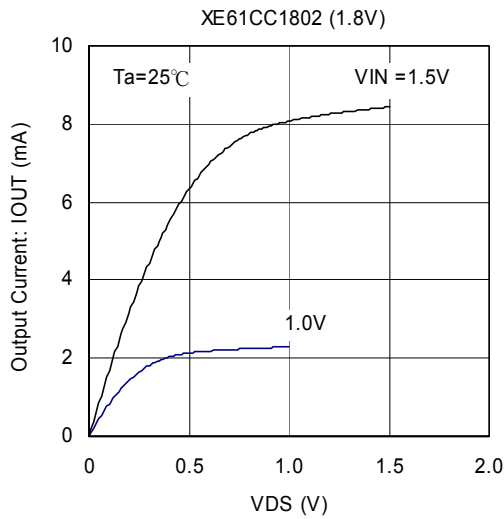

■ TYPICAL PERFORMANCE CHARACTERISTICS (Continued)

(4) N-ch Driver Output Current vs. Vds Characteristics (Continued)

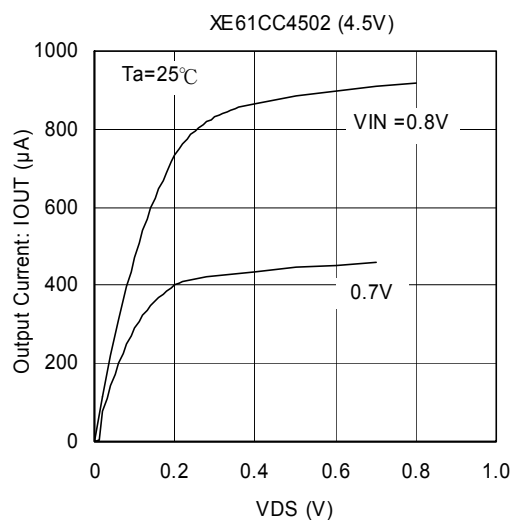
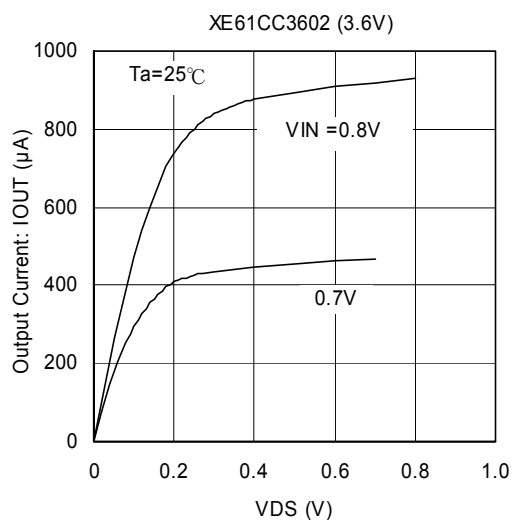

(5) N-ch Driver Output Current vs. Input Voltage

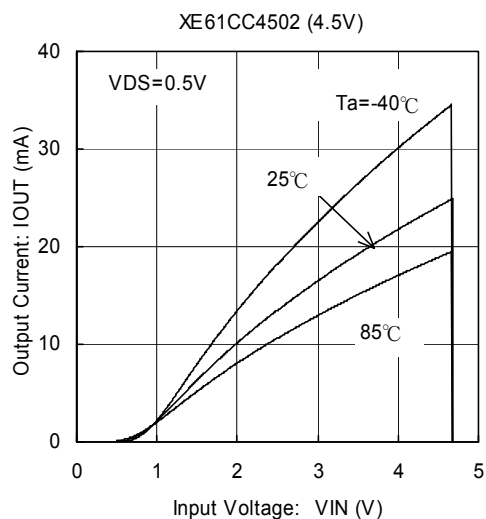
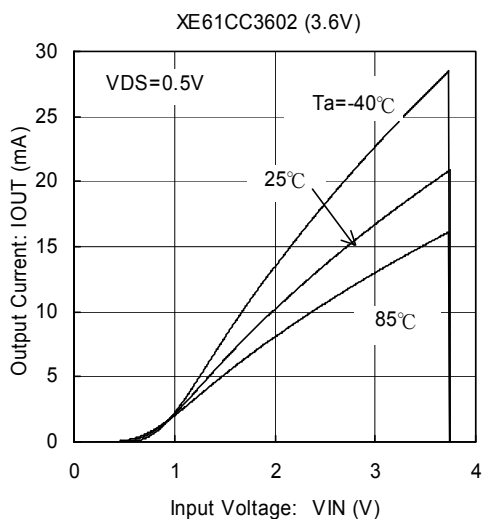
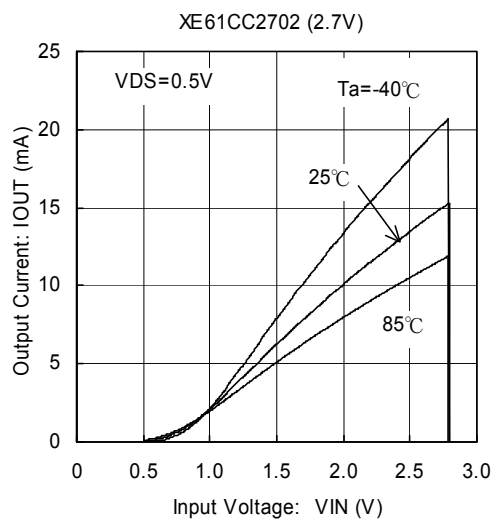
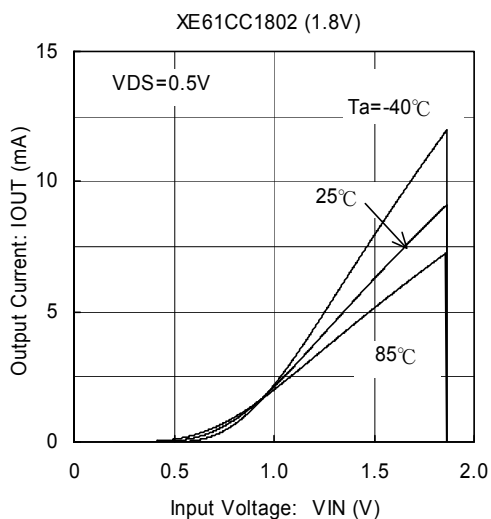

TYPICAL PERFORMANCE CHARACTERISTICS (Continued)

(6) P-ch Driver Output Current vs. Input Voltage

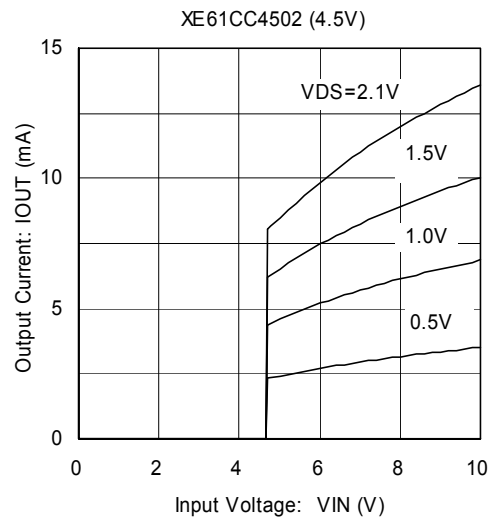
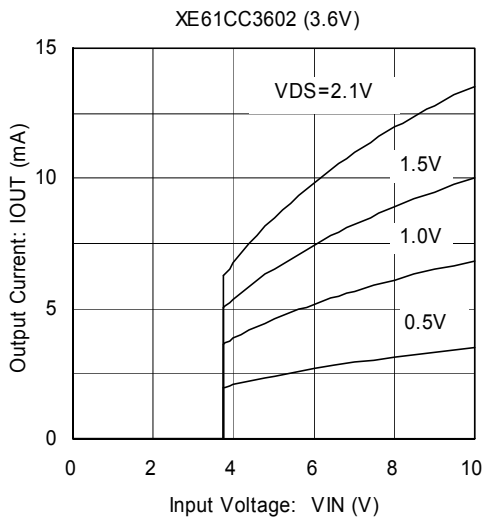
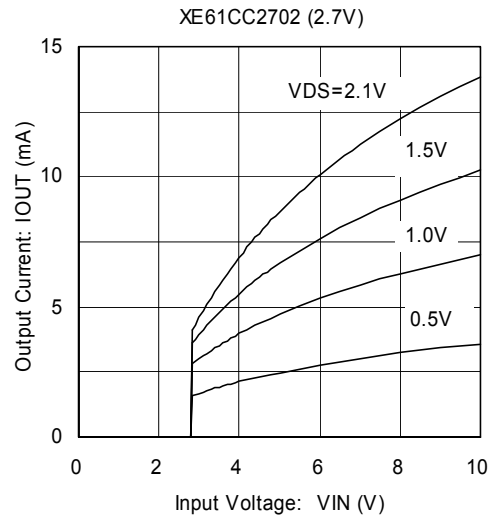
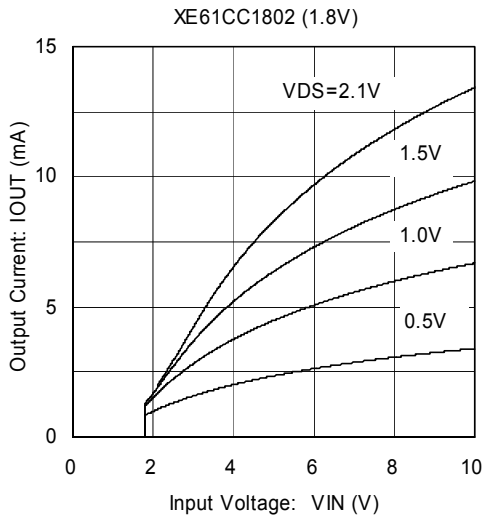

MARKING RULE

● SOT-23, SOT-89

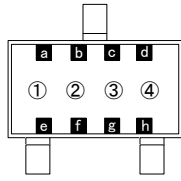

SOT-23
(TOP VIEW)

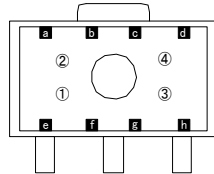

SOT-89
(TOP VIEW)

① represents integer of output configuration and detect voltage

XE61CC Series (CMOS Output)

| MARK | VOLTAGE (V) | PRODUCT SEIRES |
|------|-------------|----------------|
| B | 1.x | XE61CC1xxxx |
| C | 2.x | XE61CC2xxxx |
| D | 3.x | XE61CC3xxxx |
| E | 4.x | XE61CC4xxxx |
| F | 5.x | XE61CC5xxxx |
| H | 6.x | XE61CC6xxxx |

XE61CN Series (N-ch Open Drain Output)

| MARK | VOLTAGE (V) | PRODUCT SERIES |
|------|-------------|----------------|
| L | 1.x | XE61CN1xxxx |
| M | 2.x | XE61CN2xxxx |
| N | 3.x | XE61CN3xxxx |
| P | 4.x | XE61CN4xxxx |
| R | 5.x | XE61CN5xxxx |
| S | 6.x | XE61CN6xxxx |

② represents decimal number of detect voltage

| MARK | VOLTAGE (V) | PRODUCT SEIRES |
|------|-------------|----------------|
| 3 | x.3 | XE61Cxxx3xxx |
| 0 | x.0 | XE61Cxxx0xxx |

③ represents delay time

| MARK | DELAY TIME | PRODUCT SERIES |
|------|------------|----------------|
| 3 | No Delay | XE61Cxxx0xx |

④ represents production lot number

Based on internal standard. (G, I, J, O, Q, W excluded)

Bar Mark: a, b, c, d

| PRODUCTION YEAR | a | b | c | d |
|-----------------|--------------------------|--------------------------|--------------------------|--------------------------|
| xxx0 | <input type="checkbox"/> | - | - | - |
| xxx1 | - | <input type="checkbox"/> | - | - |
| xxx2 | - | - | <input type="checkbox"/> | - |
| xxx3 | - | - | - | <input type="checkbox"/> |
| xxx4 | <input type="checkbox"/> | <input type="checkbox"/> | - | - |
| xxx5 | <input type="checkbox"/> | - | <input type="checkbox"/> | - |
| xxx6 | <input type="checkbox"/> | - | - | <input type="checkbox"/> |
| xxx7 | - | <input type="checkbox"/> | <input type="checkbox"/> | - |
| xxx8 | - | <input type="checkbox"/> | - | <input type="checkbox"/> |
| xxx9 | - | - | <input type="checkbox"/> | <input type="checkbox"/> |

Bar Mark: e, f, g, h

| PRODUCTION MONTH | e | f | g | h |
|------------------|--------------------------|--------------------------|--------------------------|--------------------------|
| January | <input type="checkbox"/> | - | - | - |
| February | - | <input type="checkbox"/> | - | - |
| March | - | - | <input type="checkbox"/> | - |
| April | - | - | - | <input type="checkbox"/> |
| May | <input type="checkbox"/> | <input type="checkbox"/> | - | - |
| June | <input type="checkbox"/> | - | <input type="checkbox"/> | - |
| July | <input type="checkbox"/> | - | - | <input type="checkbox"/> |
| August | - | <input type="checkbox"/> | <input type="checkbox"/> | - |
| September | - | <input type="checkbox"/> | - | <input type="checkbox"/> |
| October | - | - | <input type="checkbox"/> | <input type="checkbox"/> |
| November | <input type="checkbox"/> | <input type="checkbox"/> | <input type="checkbox"/> | - |
| December | <input type="checkbox"/> | <input type="checkbox"/> | - | <input type="checkbox"/> |

1. The products and product specifications contained herein are subject to change without notice to improve performance characteristics. Consult us, or our representatives before use, to confirm that the information in this datasheet is up to date.
2. We assume no responsibility for any infringement of patents, patent rights, or other rights arising from the use of any information and circuitry in this datasheet.
3. Please ensure suitable shipping controls (including fail-safe designs and aging protection) are in force for equipment employing products listed in this datasheet.
4. The products in this datasheet are not developed, designed, or approved for use with such equipment whose failure or malfunction can be reasonably expected to directly endanger the life of, or cause significant injury to, the user.
(e.g. Atomic energy; aerospace; transport; combustion and associated safety equipment thereof.)
5. Please use the products listed in this datasheet within the specified ranges.
Should you wish to use the products under conditions exceeding the specifications, please consult us or our representatives.
6. We assume no responsibility for damage or loss due to abnormal use.
7. All rights reserved. No part of this datasheet may be copied or reproduced without the prior permission of TOREX SEMICONDUCTOR LTD.

TOREX SEMICONDUCTOR LTD.