

Automotive-grade, low power, dual, 36 V operational amplifiers



MiniSO8

[Product status link](#)[LM2904B](#)

Features

- AEC-Q100 qualified 
- Up to 36 V operating supply voltage
- Frequency compensation implemented internally
- Large DC voltage gain: 100 dB
- Wide bandwidth (unity gain): 1.2 MHz (temperature compensated)
- Very low supply current/amplifier, essentially independent of supply voltage
- Low input bias current: 20 nA (temperature compensated)
- Low input offset current: 2 nA
- Input common-mode voltage range includes negative rail
- Differential input voltage range equal to the power supply voltage
- Large output voltage swing 0 V to $V_{CC} - 1.5$ V

Applications

- Telecom equipment
- Power management
- Industrial application
- Automotive

Description

The **LM2904B** consists of two independent, high gain operational amplifiers (op-amps) that have frequency compensation implemented internally. They are designed specifically for automotive and industrial control systems. This circuit operates from a single power supply over a wide range of voltages. The **LM2904B** is guaranteed up to 36 V supply voltage operation. The low power supply drain is independent of the magnitude of the power supply voltage. Application areas include transducer amplifiers, DC gain blocks and all the conventional op-amp circuits which can now be more easily implemented in single power supply systems. For example, these circuits can be directly supplied from the standard 5 V which is used in logic systems and easily provides the required electronic interfaces without requiring any additional power supply. In linear mode, the input common-mode voltage range includes ground and the output voltage can also swing to ground, even though operated from a single power supply.

1 Schematic diagram

Figure 1. Schematic diagram

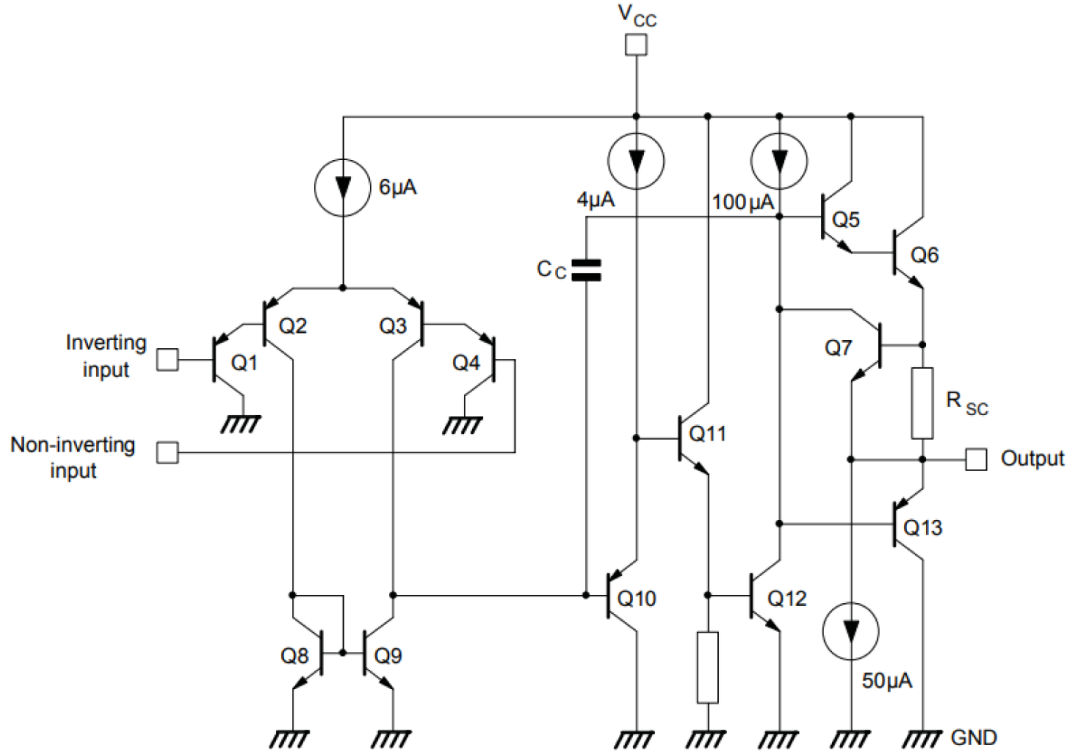
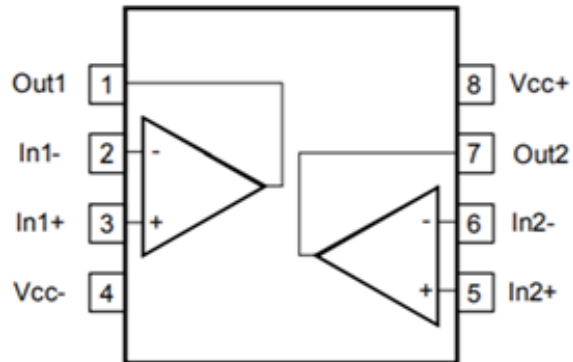

Figure 2. Pin connections (top view)



2 Absolute maximum ratings and operating conditions

Table 1. Absolute maximum ratings

Symbol	Parameter	Value	Unit
V_{CC}	Supply voltage ⁽¹⁾	±20 or 40	V
V_{id}	Differential input voltage ⁽²⁾	±40	
V_{in}	Input voltage	-0.3 to 40	
	Output short-circuit duration ⁽³⁾	Infinite	s
I_{in}	Input current: V_{IN} driven negative ⁽⁴⁾	5 mA in DC or 50 mA in AC, (duty cycle = 10 %, T = 1 s)	mA
	Input current: V_{in} driven positive above AMR value ⁽⁵⁾	0.4	
T_{stg}	Storage temperature range	-65 to 150	°C
T_j	Maximum junction temperature	150	
R_{thja}	Thermal resistance junction-to-ambient ⁽⁶⁾	190	°C/W
	MiniSO8		
R_{thjc}	Thermal resistance junction-to-case ⁽⁶⁾	39	°C/W
	MiniSO8		
ESD	HBM: human body model ⁽⁷⁾	300	V
	MM: machine model ⁽⁸⁾	200	
	CDM: charged device model ⁽⁹⁾	1500	

1. All voltage values, except differential voltage, are with respect to network ground terminal.
2. Differential voltages are the non-inverting input terminal with respect to the inverting input terminal.
3. Short-circuits from the output to V_{CC} can cause an excessive heating if $(V_{CC} +) > 15$ V. The maximum output current is approximately 40 mA, independent of the magnitude of V_{CC} . Destructive dissipation can result from simultaneous short-circuits on all amplifiers.
4. This input current only exists when the voltage at any of the input leads is driven negative. It is due to the collector-base junction of the input PNP transistor becoming forward-biased and thereby acting as an input diode clamp. In addition to this diode action, there is an NPN parasitic action on the IC chip. This transistor action can cause the output voltages of the op-amps to go to the V_{CC} voltage level (or to ground for a large overdrive) for the time during which an input is driven negative. This is not destructive and normal output is restored for input voltages above -0.3 V.
5. The junction base/substrate of the input PNP transistor polarized in reverse must be protected by a resistor in series with the inputs to limit the input current to 400 μ A max. ($R = (V_{in} - 32 \text{ V})/400 \mu\text{A}$).
6. Short-circuits can cause an excessive heating and destructive dissipation. Values are typical.
7. Human body model: a 100 pF capacitor is charged to the specified voltage, then discharged through a 1.5 k Ω resistor between two pins of the device. This is done for all couples of connected pin combinations while the other pins are floating.
8. Machine model: a 200 pF capacitor is charged to the specified voltage, then discharged directly between two pins of the device with no external series resistor (internal resistor < 5 Ω). This is done for all couples of connected pin combinations while the other pins are floating.
9. Charged device model: all pins and the package are charged together to the specified voltage and then discharged directly to the ground through only one pin. This is done for all pins.

Table 2. Operating conditions

Symbol	Parameter	Value	Unit
V_{cc}	Supply voltage	3 to 36	
V_{icm}	Common mode input voltage range $T_{amb} = 25\text{ }^{\circ}\text{C}$	V_{cc-} to $V_{cc+} - 1.5$	V
	Common mode input voltage range $T_{min} \leq T_{amb} \leq T_{max}$	V_{cc-} to $V_{cc+} - 2$	
T	Operating free-air temperature range	-40 to 125	$^{\circ}\text{C}$

3 Electrical characteristics

Table 3. Electrical characteristics, $V_{CC}=+5\text{ V}$ and 36 V , $V_{CC}=-0\text{ V}$, $V_O=1.4\text{ V}$, R_L connected to ground, $T=25\text{ }^\circ\text{C}$ (unless otherwise specified)

Symbol	Parameter	Conditions	Min.	Typ.	Max.	Unit
V_{io}	Input offset voltage ⁽¹⁾	$T = 25\text{ }^\circ\text{C}$			4	mV
		$T_{min} < T < T_{max}$			5	
$\Delta V_{io}/\Delta T$	Input offset voltage drift	$T_{min} < T < T_{max}$		7	30	$\mu\text{V}/^\circ\text{C}$
I_{io}	Input offset current	$T = 25\text{ }^\circ\text{C}$			30	nA
		$T_{min} < T < T_{max}$			40	
$\Delta I_{io}/\Delta T$	Input offset current drift	$T_{min} < T < T_{max}$		10	300	$\text{pA}/^\circ\text{C}$
I_{ib}	Input bias current ⁽²⁾	$T = 25\text{ }^\circ\text{C}$			150	nA
		$T_{min} < T < T_{max}$			200	
A_{vd}	Large signal voltage gain	$V_{CC} = 15\text{ V}$, $R_L = 2\text{ k}\Omega$, $V_O = 1.4$ to 11.4 V , $T = 25\text{ }^\circ\text{C}$	50	100		V/mV
		$V_{CC}=15\text{ V}$, $R_L=2\text{ k}\Omega$, $V_O=1.4$ to 11.4 V , $T_{min} < T < T_{max}$	25			
		$V_{CC} = 36\text{ V}$, $R_L = 2\text{ k}\Omega$, $V_O = 1.4$ to 11.4 V , $T = 25\text{ }^\circ\text{C}$	50	100		
		$V_{CC}=36\text{ V}$, $R_L=2\text{ k}\Omega$, $V_O=1.4$ to 11.4 V , $T_{min} < T < T_{max}$	25			
SVR	Supply voltage rejection ratio	$V_{CC} = 5$ to 36 V , $V_{icm} = 0\text{ V}$, $T = 25\text{ }^\circ\text{C}$	65	100		dB
		$V_{CC} = 5$ to 36 V , $V_{icm} = 0\text{ V}$, $T_{min} < T < T_{max}$	65			
I_{CC}	Supply current	All amps, no load, $V_{CC} = 5\text{ V}$, $T = 25\text{ }^\circ\text{C}$		0.45	0.6	mA
		All amps, no load, $V_{CC} = 5\text{ V}$, $T_{min} < T < T_{max}$			1	
		All amps, no load, $V_{CC} = 36\text{ V}$, $T = 25\text{ }^\circ\text{C}$		0.7	1.2	
		All amps, no load, $V_{CC} = 36\text{ V}$, $T_{min} < T < T_{max}$			2.0	
CMR	Common-mode rejection ratio	$V_{CC} = 36\text{ V}$, $V_{icm} = 0$ to 34.5 V , $T = 25\text{ }^\circ\text{C}$	70	85		dB
		$V_{CC} = 36\text{ V}$, $V_{icm} = 0$ to 34 V , $T_{min} < T < T_{max}$	60			
I_{source}	Output source current	$V_{CC} = 36\text{ V}$, $V_O = 2\text{ V}$, $V_{id} = 1\text{ V}$	25	32	40	mA
I_{sink}	Output sink current	$V_{CC} = 36\text{ V}$, $V_O = 2\text{ V}$	15	18		mA
		$V_{CC} = 36\text{ V}$, $V_O = 0.2\text{ V}$	70	94		μA
V_{oh}	High-level output voltage	$V_{CC} = 36\text{ V}$, $R_L = 2\text{ k}\Omega$, $T = 25\text{ }^\circ\text{C}$	32	33		V
		$V_{CC} = 36\text{ V}$, $R_L = 2\text{ k}\Omega$, $T_{min} < T < T_{max}$	32			
		$V_{CC} = 36\text{ V}$, $R_L = 10\text{ k}\Omega$, $T = 25\text{ }^\circ\text{C}$	33	34		
		$V_{CC} = 36\text{ V}$, $R_L = 10\text{ k}\Omega$, $T_{min} < T < T_{max}$	33			
V_{ol}	Low-level output voltage	$V_{CC} = 5\text{ V}$, $R_L = 10\text{ k}\Omega$, $T = 25\text{ }^\circ\text{C}$		5	20	mV
		$V_{CC} = 5\text{ V}$, $R_L = 10\text{ k}\Omega$, $T_{min} < T < T_{max}$			20	
		$V_{CC} = 36\text{ V}$, $R_L = 10\text{ k}\Omega$, $T = 25\text{ }^\circ\text{C}$		5	20	
		$V_{CC} = 36\text{ V}$, $R_L = 10\text{ k}\Omega$, $T_{min} < T < T_{max}$			20	
SR	Slew rate	$V_{CC} = 15\text{ V}$, $V_{in} = 0.5$ to 3 V , $R_L = 2\text{ k}\Omega$, $C_L = 100\text{ pF}$, unity gain, $T=25\text{ }^\circ\text{C}$	0.3	0.6		V/ μs

Symbol	Parameter	Conditions	Min.	Typ.	Max.	Unit
SR	Slew rate	$V_{CC} = 15\text{ V}$, $V_{in} = 0.5\text{ to }3\text{ V}$, $R_L = 2\text{ k}\Omega$, $C_L = 100\text{ pF}$, unity gain, $T_{min} < T < T_{max}$	0.2			V/ μ s
		$V_{CC} = 36\text{ V}$, $V_{in} = 0.5\text{ to }3\text{ V}$, $R_L = 2\text{ k}\Omega$, $C_L = 100\text{ pF}$, unity gain, $T = 25\text{ }^\circ\text{C}$	0.5	0.75		
		$V_{CC} = 36\text{ V}$, $V_{in} = 0.5\text{ to }3\text{ V}$, $R_L = 2\text{ k}\Omega$, $C_L = 100\text{ pF}$, unity gain, $T_{min} < T < T_{max}$	0.4			
GBP	Gain bandwidth product	$V_{CC} = 36\text{ V}$, $f = 100\text{ kHz}$, $V_{in} = 10\text{ mV}$, $R_i = 2\text{ k}\Omega$, $C_i = 100\text{ pF}$	0.8	1.2		MHz
Vo1 / Vo2	Channel separation ⁽³⁾	$V_{CC} = 30\text{ V}$, $1\text{ kHz} \leq f \leq 20\text{ kHz}$		120		dB

- $V_O = 1.4\text{ V}$, $5\text{ V} \leq V_{CC} \leq 36\text{ V}$, $0 \leq V_{icm} \leq V_{CC} - 1.5\text{ V}$.
- The direction of the input current is out of the IC. This current is essentially constant as long as the output is not saturated, so there is no change in the loading charge on the input lines.
- Due to the proximity of external components, ensure that the stray capacitance does not cause coupling between these external parts. This can typically be detected at higher frequencies because this type of capacitance increases.

Figure 3. Supply current vs. supply voltage

Figure 4. Offset voltage production distribution at $V_{CC} = 36\text{ V}$

Figure 5. Input offset voltage vs. temperature at $V_{CC} = 36\text{ V}$

Figure 6. Input offset voltage vs. common-mode voltage at $V_{CC} = 36\text{ V}$

Figure 7. Input bias current vs. temperature

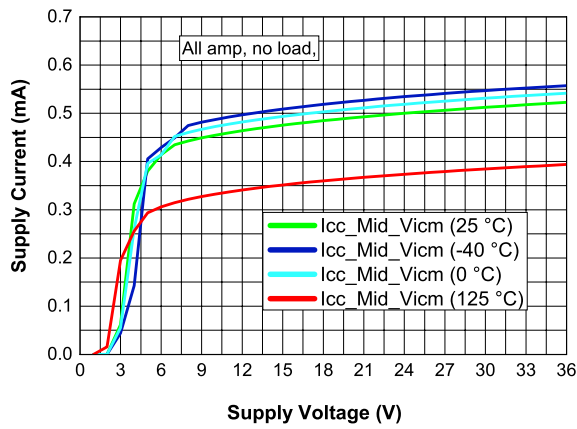
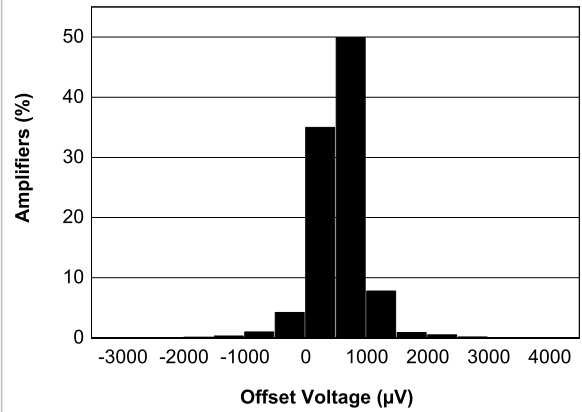
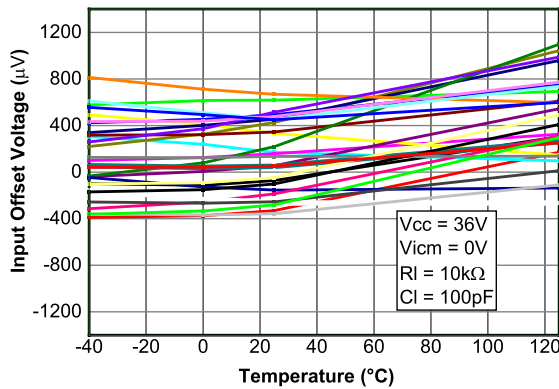
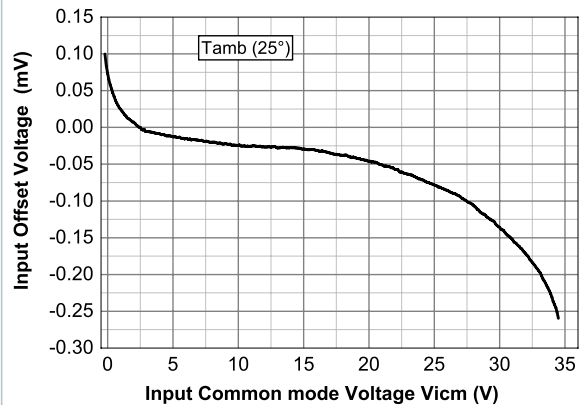
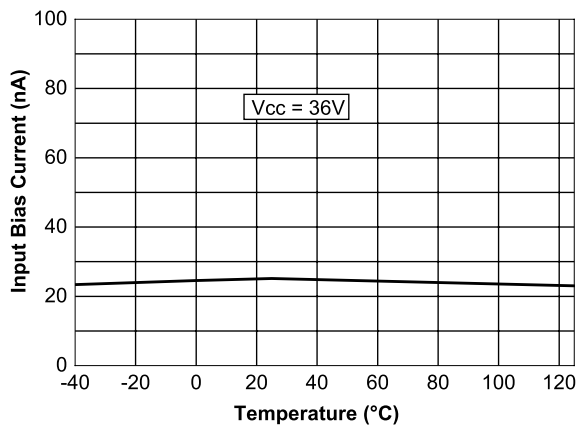
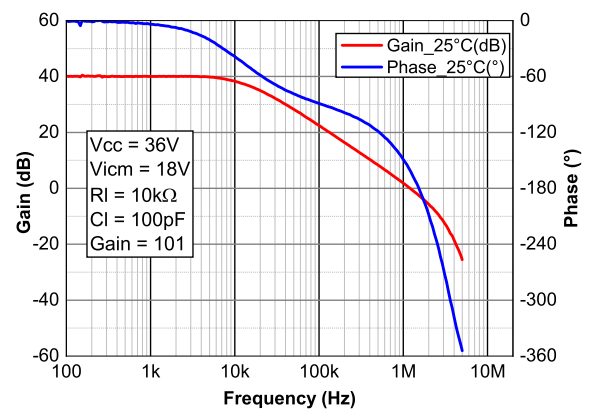
Figure 8. Gain and phase vs. freq. at $V_{CC}=36\text{ V}$

Figure 9. Phase margin vs. capacitive load at $V_{CC}=36\text{ V}$

Figure 10. Overshoot vs. capacitive load at $V_{CC}=36\text{ V}$

Figure 11. Output voltage vs. output current (sinking)

Figure 12. Output voltage vs. output current (sourcing)

Figure 13. Current limiting vs. temperature

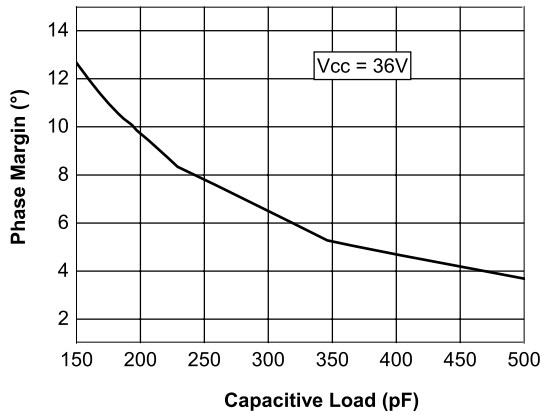
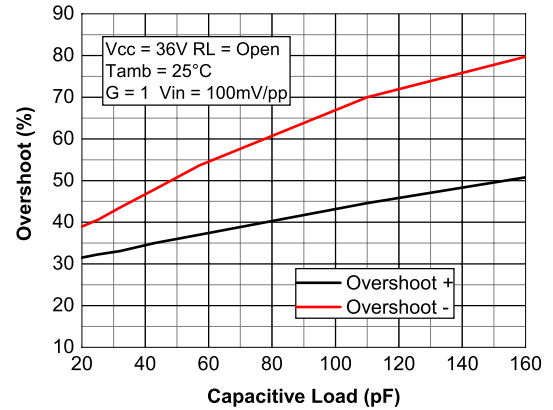
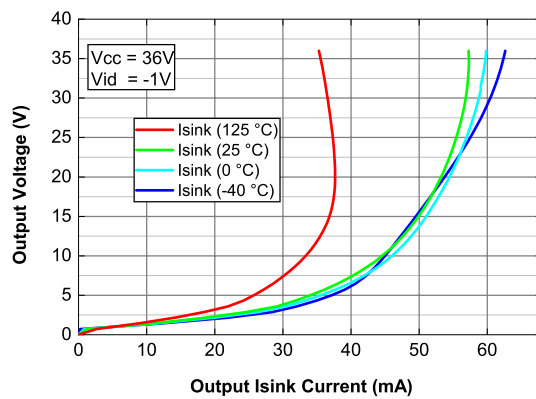
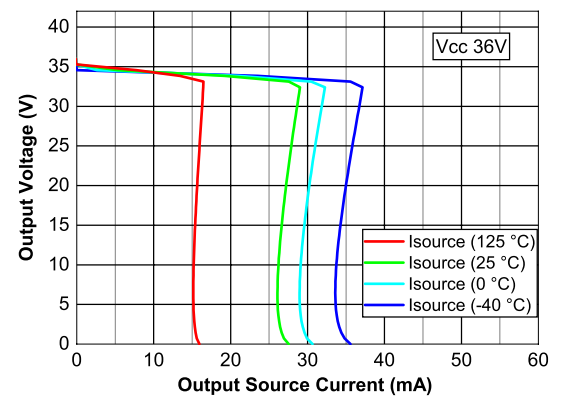
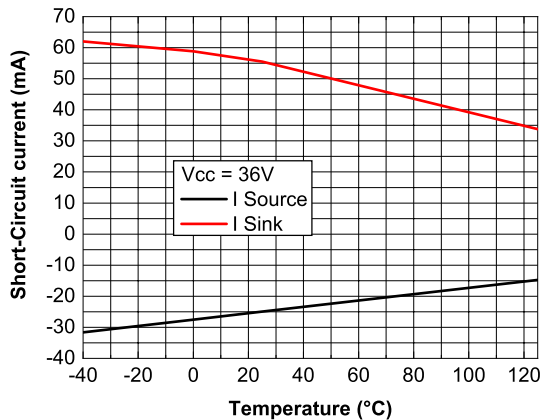
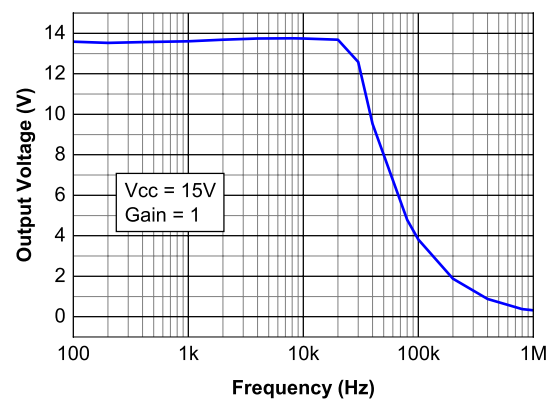
Figure 14. Maximum output voltage vs. frequency at $V_{CC}=15\text{ V}$

Figure 15. Slew rate behavior at $V_{CC} = 36\text{ V}$

Figure 16. Slew rate behavior vs. temperature at $V_{CC} = 36\text{ V}$

Figure 17. Common-mode rejection ratio and power supply rejection ratio at $V_{CC} = 5\text{ V}$

Figure 18. Noise vs. frequency at $V_{CC} = 36\text{ V}$

Figure 19. THD + N vs. voltage at $V_{CC} = 36\text{ V}$

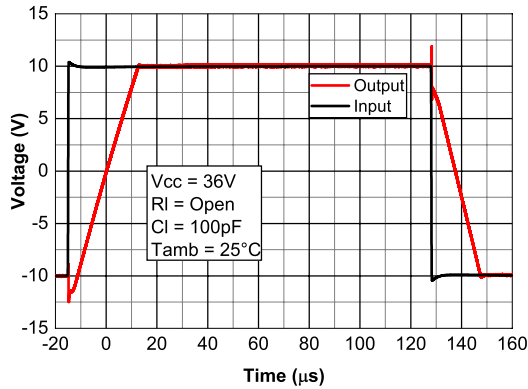
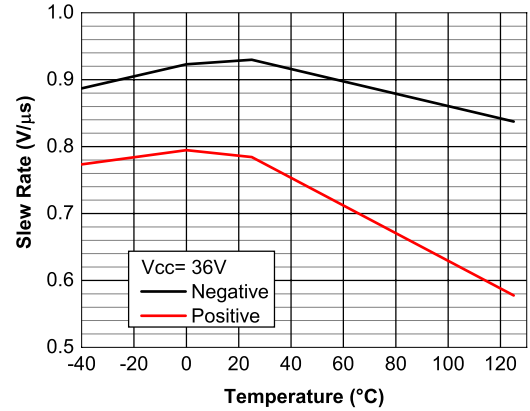
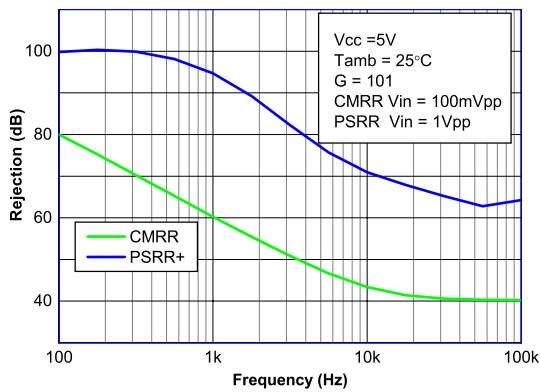
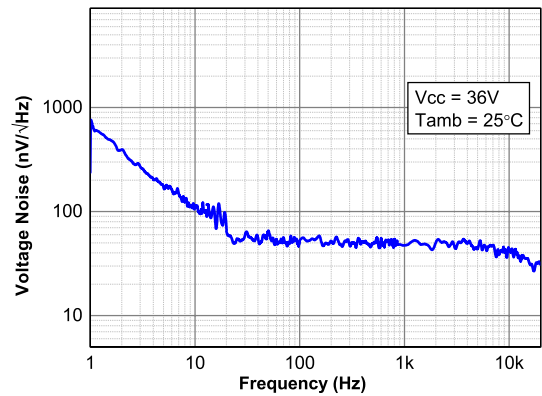
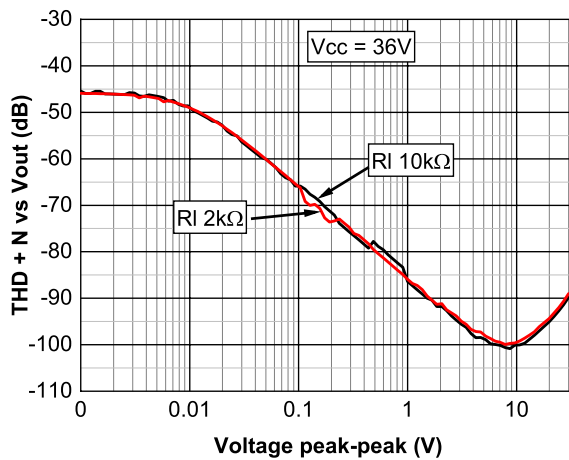
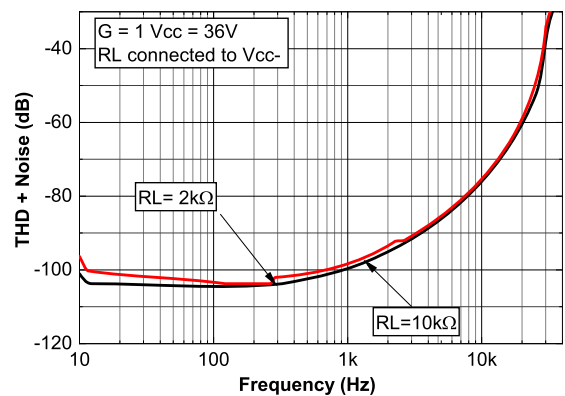
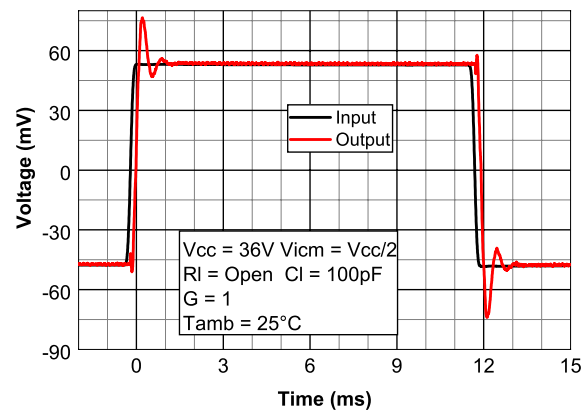
Figure 20. THD + N vs. frequency at $V_{CC} = 36\text{ V}$

Figure 21. Small-signal step response vs. time at $V_{CC} = 36\text{ V}$



4 Package information

In order to meet environmental requirements, ST offers these devices in different grades of **ECOPACK** packages, depending on their level of environmental compliance. ECOPACK specifications, grade definitions and product status are available at: www.st.com. ECOPACK is an ST trademark.

4.1 MiniSO8 package information

Figure 22. MiniSO8 package outline

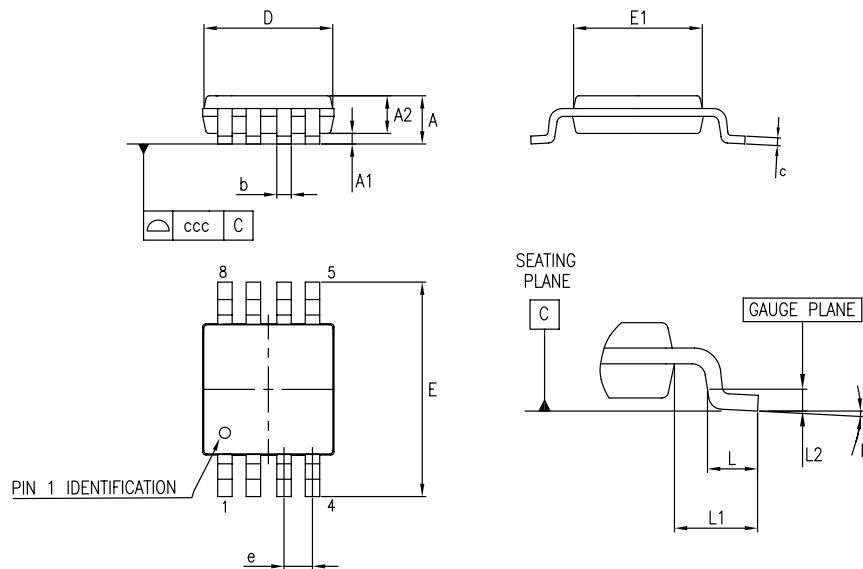

Table 4. MiniSO8 mechanical data

Dim.	Millimeters			Inches		
	Min.	Typ.	Max.	Min.	Typ.	Max.
A			1.1			0.043
A1	0		0.15	0		0.006
A2	0.75	0.85	0.95	0.03	0.033	0.037
b	0.22		0.4	0.009		0.016
c	0.08		0.23	0.003		0.009
D	2.8	3	3.2	0.11	0.118	0.126
E	4.65	4.9	5.15	0.183	0.193	0.203
E1	2.8	3	3.1	0.11	0.118	0.122
e		0.65			0.026	
L	0.4	0.6	0.8	0.016	0.024	0.031
L1		0.95			0.037	
L2		0.25			0.01	
k	0°		8°	0°		8°
ccc			0.1			0.004

5 Ordering information

Table 5. Ordering information

Order code	Temperature range	Package	Packaging	Marking
LM2904BYST ⁽¹⁾	-40 to +125°C	MiniSO8	Tape and reel	K2F

1. Qualified and characterized according to AEC Q100 and Q003 or equivalent, advanced screening according to AEC Q001 & Q 002 or equivalent.

Revision history

Table 6. Document revision history

Date	Version	Changes
09-Dec-2020	1	Initial release.
15-Dec-2020	2	Updated Table 3. Electrical characteristics, $V_{cc+} = 5\text{ V}$ and 36 V , $V_{cc-} = 0\text{ V}$, $V_o = 1.4\text{ V}$, R_L connected to ground, $T = 25\text{ }^\circ\text{C}$ (unless otherwise specified).
18-Oct-2021	3	Updated the title and Section Features.
22-Feb-2022	4	Updated Section Features .

Contents

1	Schematic diagram	2
2	Absolute maximum ratings and operating conditions	3
3	Electrical characteristics	5
4	Package information	11
4.1	MiniSO8 package information	11
5	Ordering information	12
	Revision history	13

List of figures

Figure 1.	Schematic diagram	2
Figure 2.	Pin connections (top view).	2
Figure 3.	Supply current vs. supply voltage	7
Figure 4.	Offset voltage production distribution at $V_{CC} = 36\text{ V}$	7
Figure 5.	Input offset voltage vs. temperature at $V_{CC} = 36\text{ V}$	7
Figure 6.	Input offset voltage vs. common-mode voltage at $V_{CC} = 36\text{ V}$	7
Figure 7.	Input bias current vs. temperature	7
Figure 8.	Gain and phase vs. freq. at $V_{CC}=36\text{ V}$	7
Figure 9.	Phase margin vs. capacitive load at $V_{CC}=36\text{ V}$	8
Figure 10.	Overshoot vs. capacitive load at $V_{CC}=36\text{ V}$	8
Figure 11.	Output voltage vs. output current (sinking)	8
Figure 12.	Output voltage vs. output current (sourcing)	8
Figure 13.	Current limiting vs. temperature	8
Figure 14.	Maximum output voltage vs. frequency at $V_{CC} = 15\text{ V}$	8
Figure 15.	Slew rate behavior at $V_{CC} = 36\text{ V}$	9
Figure 16.	Slew rate behavior vs. temperature at $V_{CC} = 36\text{ V}$	9
Figure 17.	Common-mode rejection ratio and power supply rejection ratio at $V_{CC} = 5\text{ V}$	9
Figure 18.	Noise vs. frequency at $V_{CC} = 36\text{ V}$	9
Figure 19.	THD + N vs. voltage at $V_{CC} = 36\text{ V}$	9
Figure 20.	THD + N vs. frequency at $V_{CC} = 36\text{ V}$	9
Figure 21.	Small-signal step response vs. time at $V_{CC} = 36\text{ V}$	10
Figure 22.	MiniSO8 package outline	11

IMPORTANT NOTICE – PLEASE READ CAREFULLY

STMicroelectronics NV and its subsidiaries (“ST”) reserve the right to make changes, corrections, enhancements, modifications, and improvements to ST products and/or to this document at any time without notice. Purchasers should obtain the latest relevant information on ST products before placing orders. ST products are sold pursuant to ST’s terms and conditions of sale in place at the time of order acknowledgement.

Purchasers are solely responsible for the choice, selection, and use of ST products and ST assumes no liability for application assistance or the design of Purchasers’ products.

No license, express or implied, to any intellectual property right is granted by ST herein.

Resale of ST products with provisions different from the information set forth herein shall void any warranty granted by ST for such product.

ST and the ST logo are trademarks of ST. For additional information about ST trademarks, please refer to www.st.com/trademarks. All other product or service names are the property of their respective owners.

Information in this document supersedes and replaces information previously supplied in any prior versions of this document.

© 2022 STMicroelectronics – All rights reserved