

## 7A 800V N-channel Enhancement Mode Power MOSFET

### 1 Description

The F7N80 is an N-channel enhancement mode power field effect transistor. It optimized stripe cell structure design improves the EAS capability of the device. Which accords with the RoHS standard.

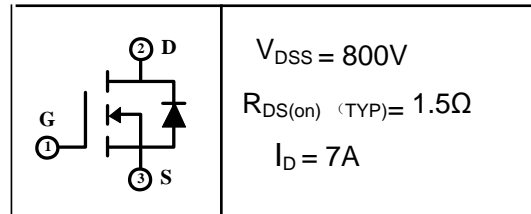

### 2 Features

- Low Gate Charge
- Excellent RDSON
- Fast Switching
- Low ON Resistance
- 100% Single Pulse Avalanche Energy Test
- 100%  $\Delta V_{DS}$  Test

### 3 Applications

- LED Power Switch Circuit
- Electronic Ballast
- ATX Power
- High Voltage H Bridge PWM Motor Drive



### 4 Electrical Characteristics

#### 4.1 Absolute Maximum Rating (Tc=25°C, unless otherwise noted)

PARAMETER	SYMBOL	VALUE	UNIT	
Drain-Source Voltage	$V_{DS}$	800	V	
Gate-Drain Voltage	$V_{GS}$	$\pm 30$	V	
Drain Current(continuous)	$I_D (T=25^\circ C)$ $(T=100^\circ C)$	7	A	
		4	A	
Drain Current(Pulsed) <sup>(Note 1)</sup>	$I_{DM}$	28	A	
Single Pulse Avalanche Energy <sup>(Note 5)</sup>	$E_{AS}$	150	mJ	
Avalanche Energy Repetitive <sup>(Note 1)</sup>	$E_{AR}$	20	mJ	
Avalanche Current <sup>(Note 1)</sup>	$I_{AR}$	2	A	
Peak Diode Recovery dv/dt <sup>(Note 6)</sup>	dv/dt	5	V/ns	
Total Dissipation	$T_a=25^\circ C$	$P_{tot}$	2	W
	$T_C=25^\circ C$	$P_{tot}$	48	W
Junction Temperature	$T_j$	150	°C	
storage Temperature	$T_{stg}$	-55~150	°C	
Maximum Temperature for soldering	$T_L$	300	°C	

#### 4.2 Thermal Characteristics

PARAMETER	SYMBOL	VALUE	UNIT
Thermal Resistance Junction to Case-sink	$R_{thJC}$	2.6	°C/W
Thermal Resistance Junction to Ambient	$R_{thJA}$	62.5	°C/W

**4.3 Electrical Characteristics** (Tc=25°C, unless otherwise noted)

PARAMETER	SYMBOL	Test Condition	VALUE			UNIT
			MIN	TYP	MAX	
<b>Off Characteristics</b>						
Drain-source Breakdown Voltage	$BV_{DSS}$	$I_D=250\mu A, V_{GS}=0V$	800	--	--	V
Drain-to-Source Leakage Current	$I_{DSS}$	$V_{DS}=800V, V_{GS}=0V, T_C=25^\circ C$	--	--	25	$\mu A$
		$V_{DS}=640V, V_{GS}=0V, T_C=125^\circ C$	--	--	250	$\mu A$
Gate-to-Source Forward Leakage	$I_{GSSF}$	$V_{GS}=+30V, V_{DS}=0V$	--	--	100	nA
Gate-to-Source Reverse Leakage	$I_{GSSR}$	$V_{GS}= - 30V, V_{DS}=0V$	--	--	-100	nA
<b>On Characteristics</b> (Note 3)						
Gate threshold voltage	$V_{GS(th)}$	$V_{DS}=V_{GS}, I_D=250\mu A$	2	--	4	V
Drain-source on Resistance	$R_{DS(on)}$	$V_{GS}=10V, I_D=3.5A$	--	1.5	1.8	$\Omega$
<b>Dynamic Characteristics</b> (Note 4)						
Forward Transfer conductance	$g_{fs}$	$V_{DS}=15V, I_D=3.5A$	--	7.5	--	S
Input Capacitance	$C_{iss}$	$V_{GS}=0V, V_{DS}=25V, f=1.0MHz$	--	1350	--	pF
Output Capacitance	$C_{oss}$		--	115	--	
Reverse Transfer Capacitance	$C_{rss}$		--	12	--	
<b>Switching Characteristics</b> (note4)						
Turn-on Delay Time	$t_{d(on)}$	$I_D=7A, V_{DD}=400V, V_{GS}=10V, R_G=12\Omega$	--	15	--	nS
Turn-on Rise Time	$t_r$		--	25	--	nS
Turn-off Delay Time	$t_{d(off)}$		--	51	--	nS
Turn-off Fall Time	$t_f$		--	31	--	nS
Total Gate Charge	$Q_g$	$I_D=7A, V_{DD}=400V, V_{GS}=10V$	--	34	--	nC
Gate-to-Source Charge	$Q_{gs}$		--	6	--	
Gate-to-Drain("Miller") Charge	$Q_{gd}$		--	14	--	
<b>Drain-Source Diode Characteristics</b>						
Diode Forward Voltage (Note 3)	$V_{FSD}$	$V_{GS}=0V, I_S=7A$	--	--	1.5	V
Diode Forward Current (Note 2)	$I_S$		--	--	7	A
Reverse Recovery Time	$t_{rr}$	$T_J=25^\circ C, I_F=7A, di_F/dt=100A/\mu S, V_{GS}=0V$	--	186	--	nS
Reverse Recovery Charge	$Q_{rr}$		--	878	--	nC

Notes:

- 1: Repetitive rating, pulse width limited by maximum junction temperature.
- 2: Surface mounted on FR4 Board,  $t \leq 10sec$ .
- 3: Pulse width  $\leq 300\mu s$ , duty cycle  $\leq 2\%$ .
- 4: Guaranteed by design, not subject to production.
5.  $L=10mH, I_D=5.5A, V_{DD}=50V, V_{GATE}=800V, Start T_J=25^\circ C$ .
6.  $I_{SD}=7A, di/dt \leq 100A/\mu s, V_{DD} \leq BV_{DSS}, Start T_J=25^\circ C$ .

**5 Typical characteristics diagrams**

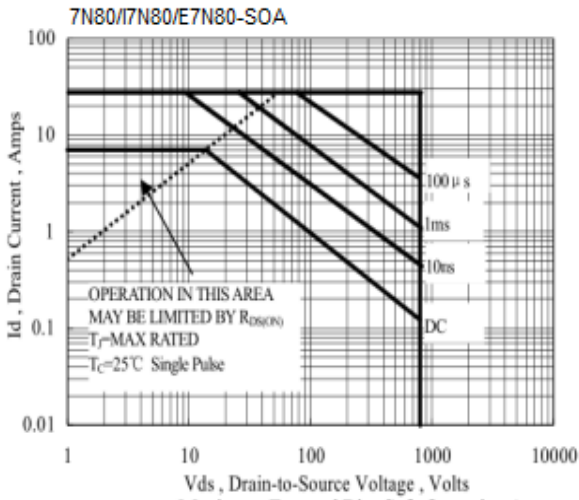

Figure 1a Maximum Forward Bias Safe Operating Area

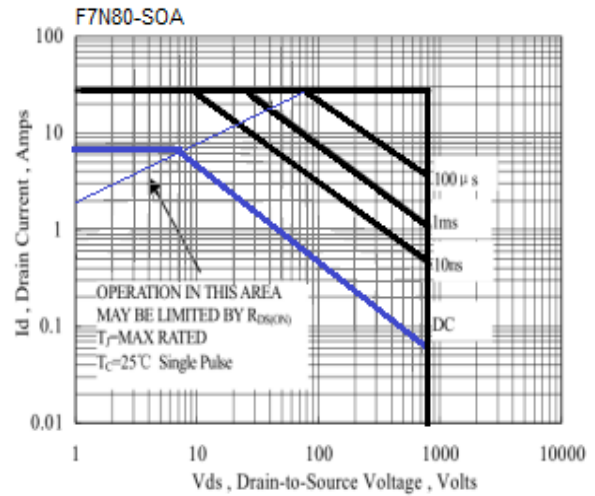

Figure 1b Maximum Forward Bias Safe Operating Area

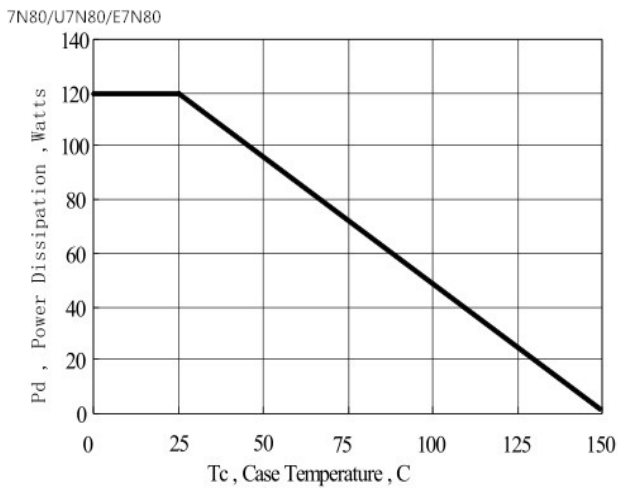

Figure.2(a) Maximum Power Dissipation VS Case Temperature

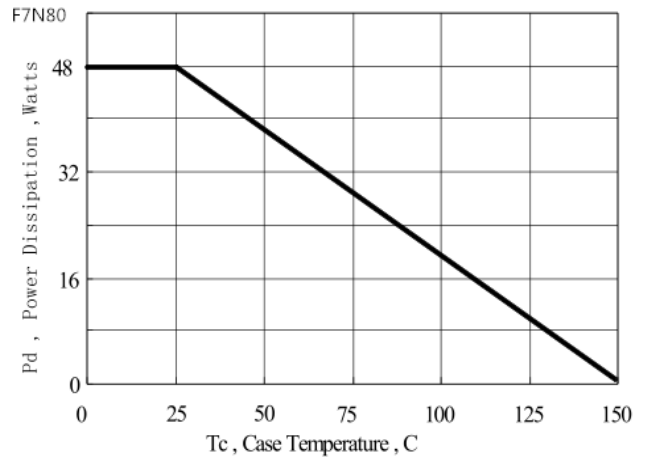

Figure.2(b) Maximum Power Dissipation VS Case Temperature

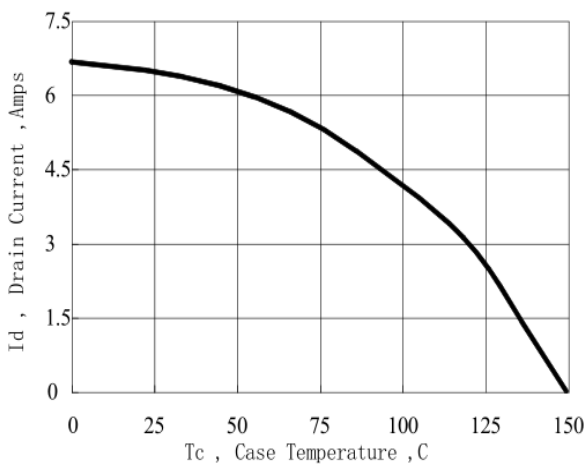

Figure 3 Maximum Continuous Drain Current vs Case Temperature

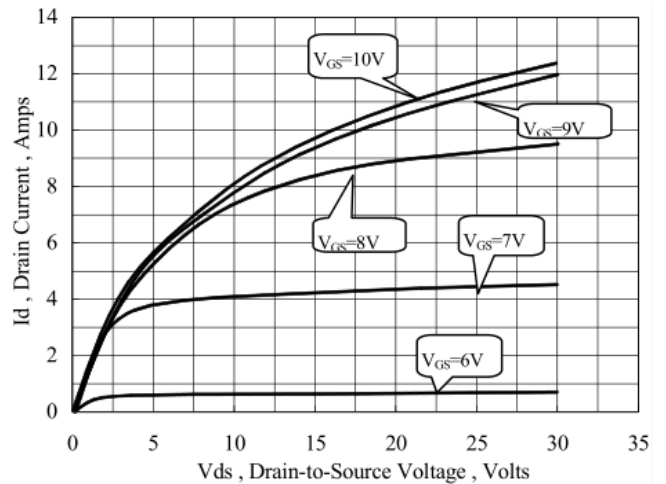
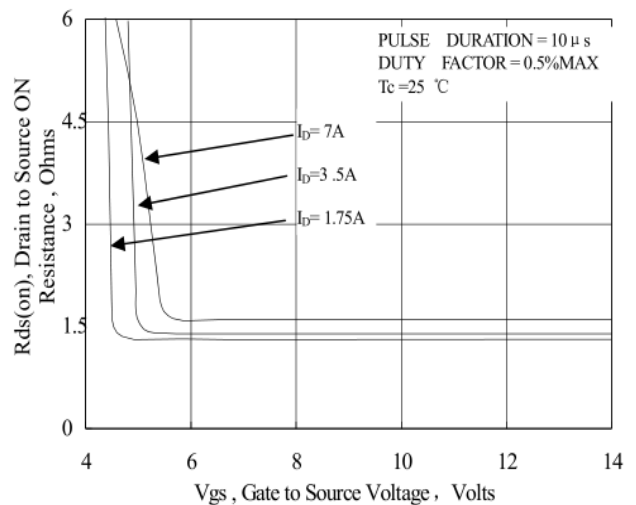
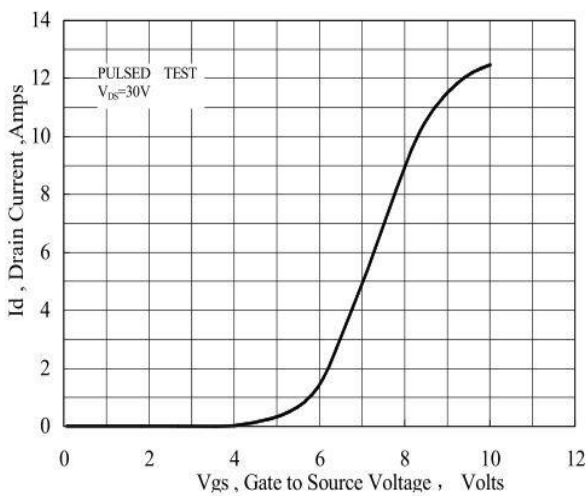
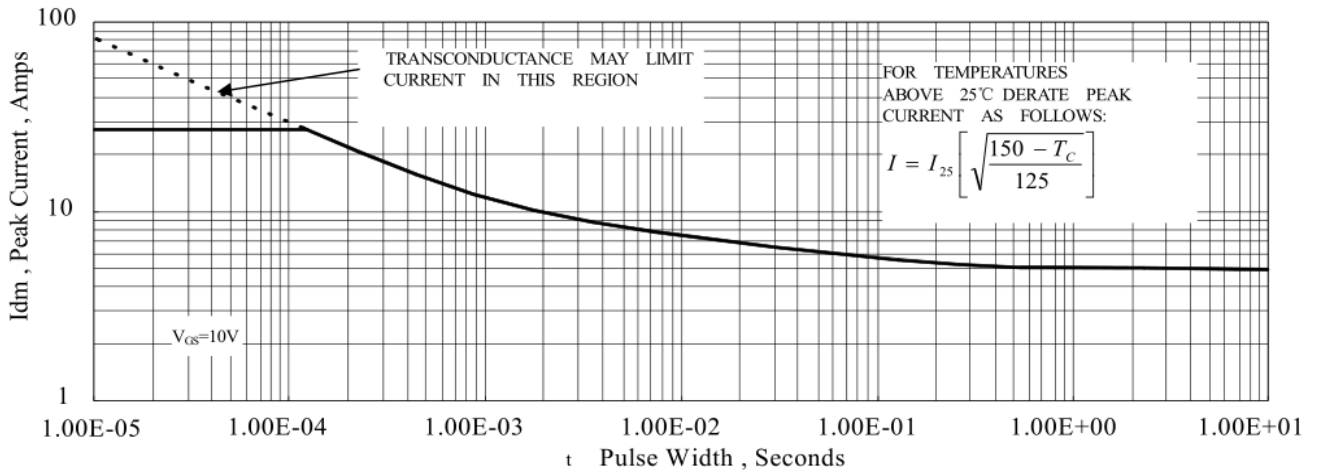
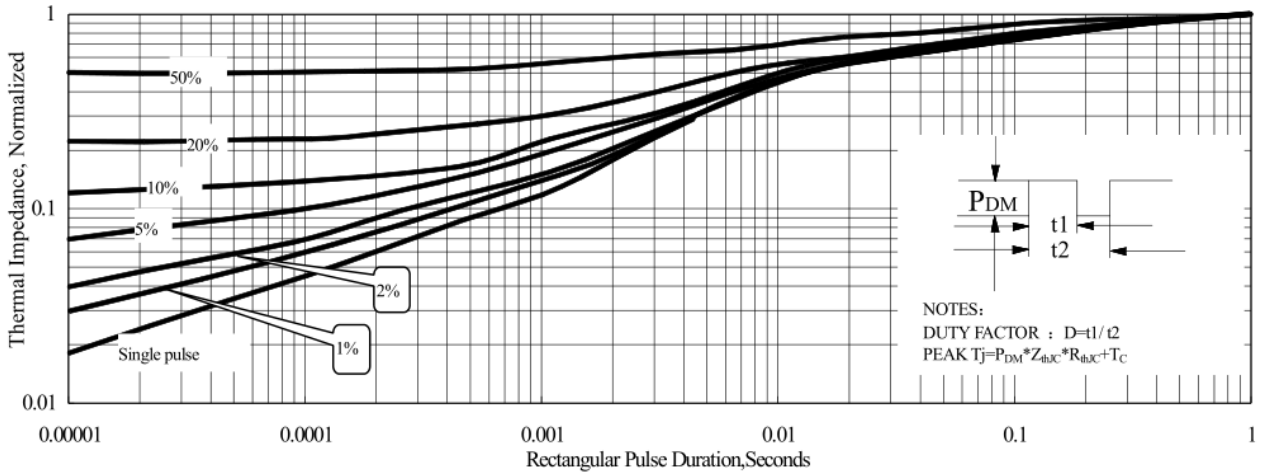

Figure 4 Typical Output Characteristics

**5 Typical characteristics diagrams(continues)**



**5 Typical characteristics diagrams(continues)**

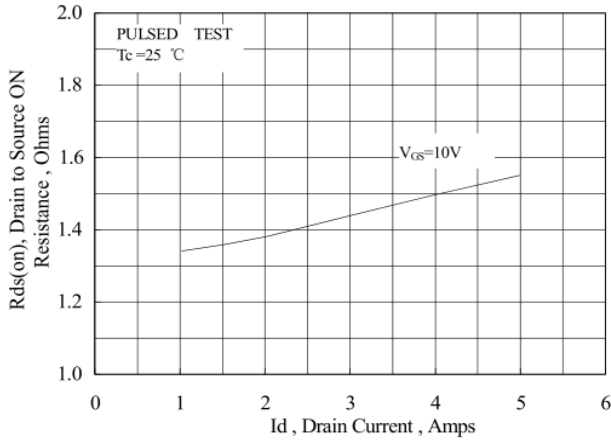

Figure 9 Typical Drain to Source ON Resistance vs Drain Current

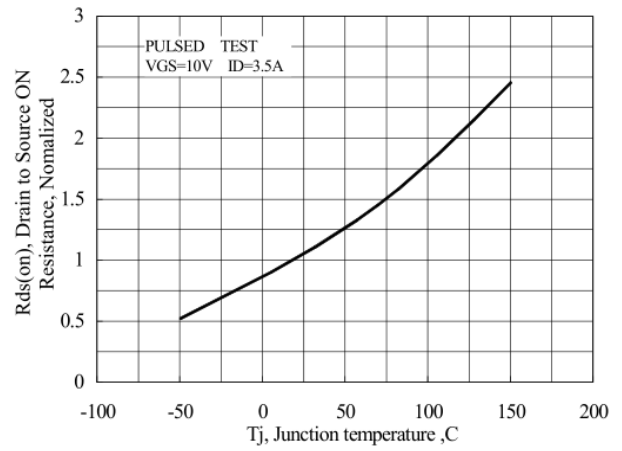

Figure 10 Typical Drain to Source on Resistance vs Junction Temperature

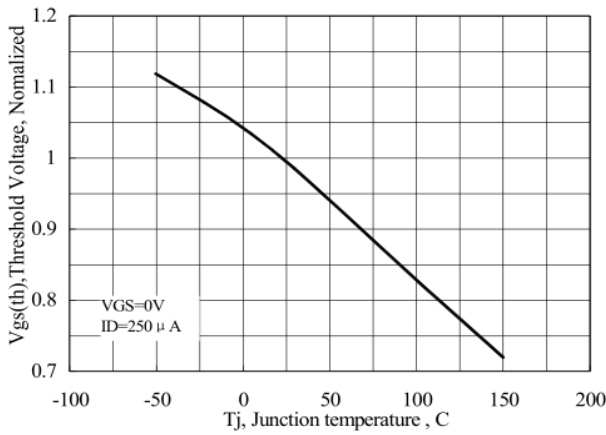

Figure 11 Typical Threshold Voltage vs Junction Temperature

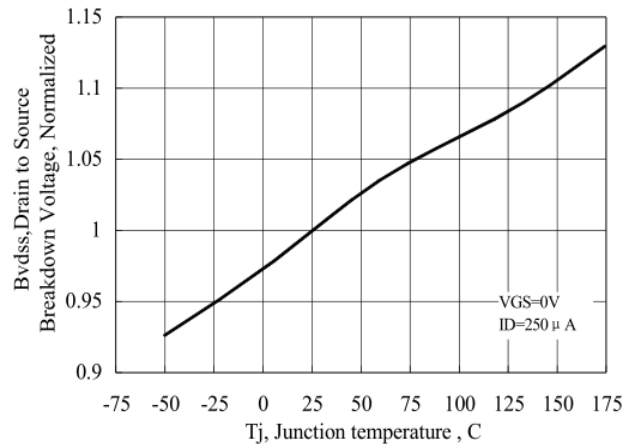

Figure 12 Typical Breakdown Voltage vs Junction Temperature

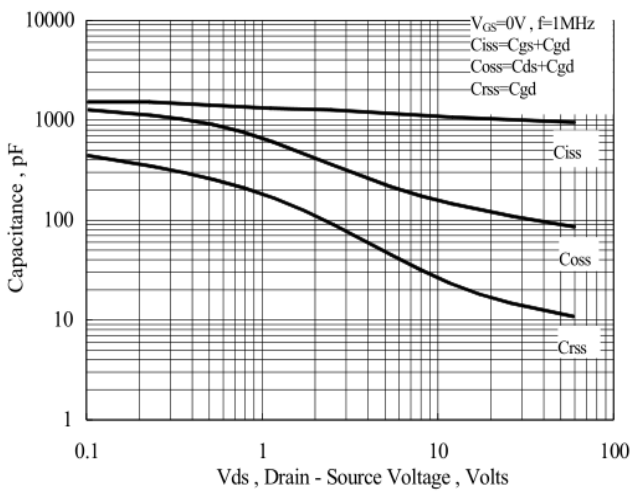

Figure 13 Typical Capacitance vs Drain to Source Voltage

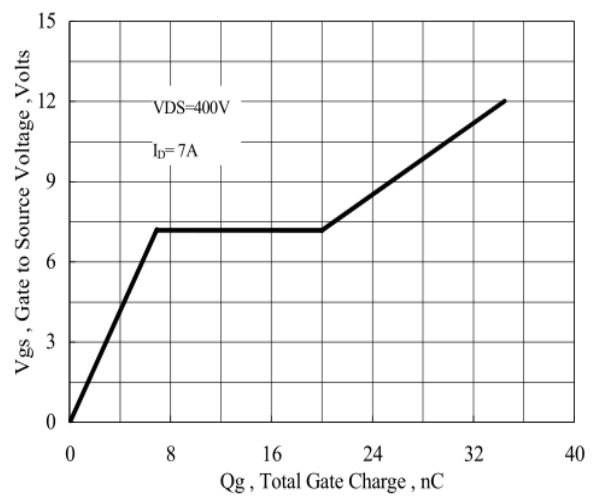

Figure 14 Typical Gate Charge vs Gate to Source Voltage

**5 Typical characteristics diagrams(continues)**

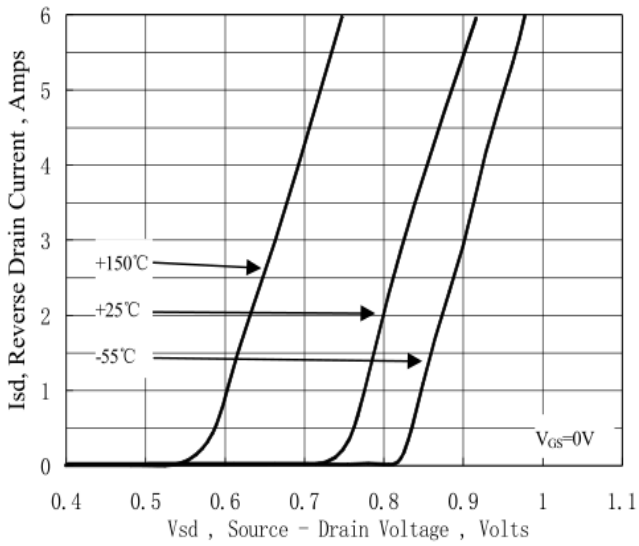

Figure 15 Typical Body Diode Transfer Characteristics

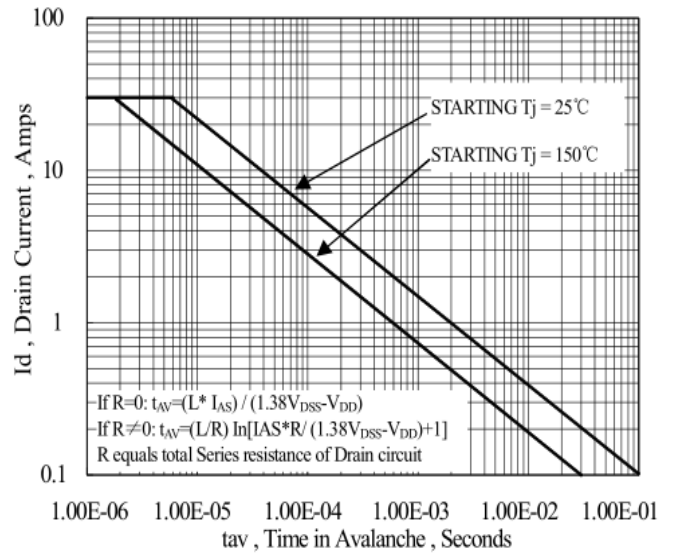
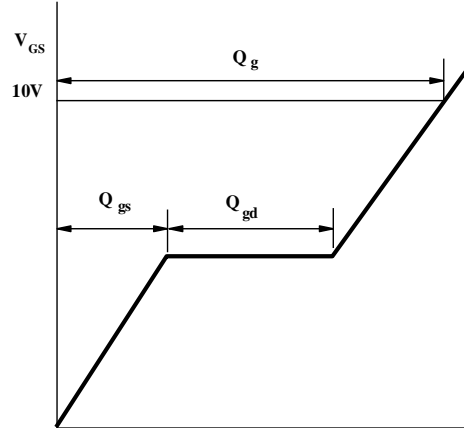
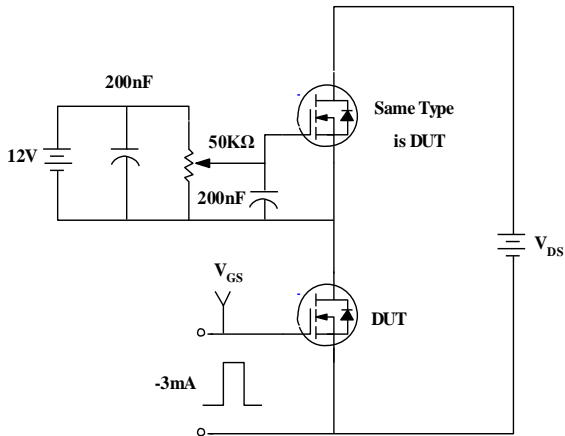
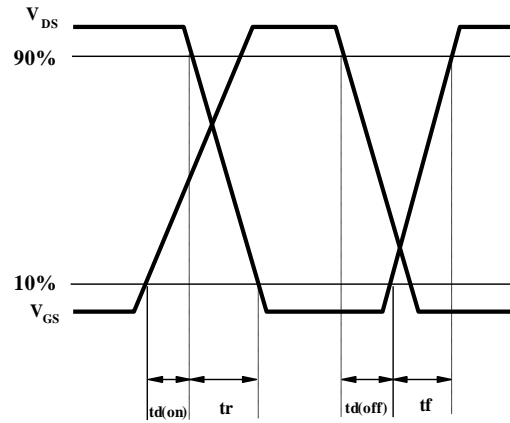
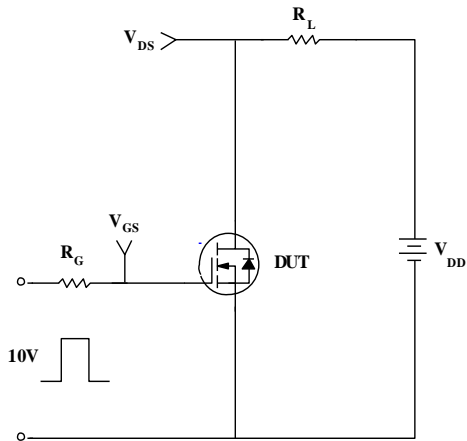

Figure 16 Unclamped Inductive Switching Capability

**6 Typical Test Circuit and Waveform**



**1) Gate Charge Test Circuit & Waveform**



**2) Switching Test Circuit & Waveforms**

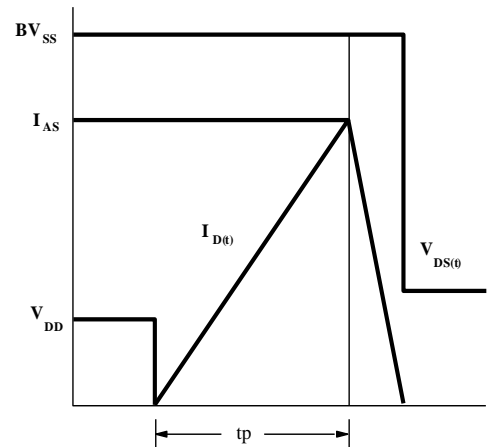
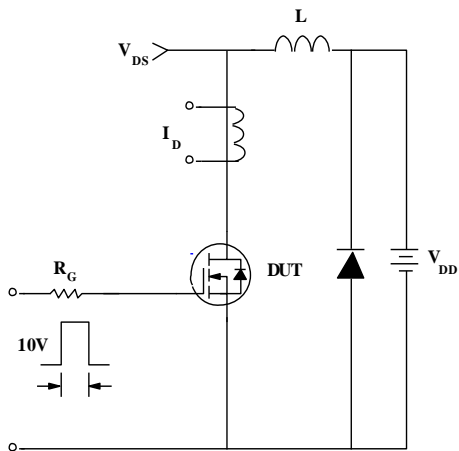

**3) Unclamped Inductive Test Circuit & Waveforms**

**7 Product Names Rules**

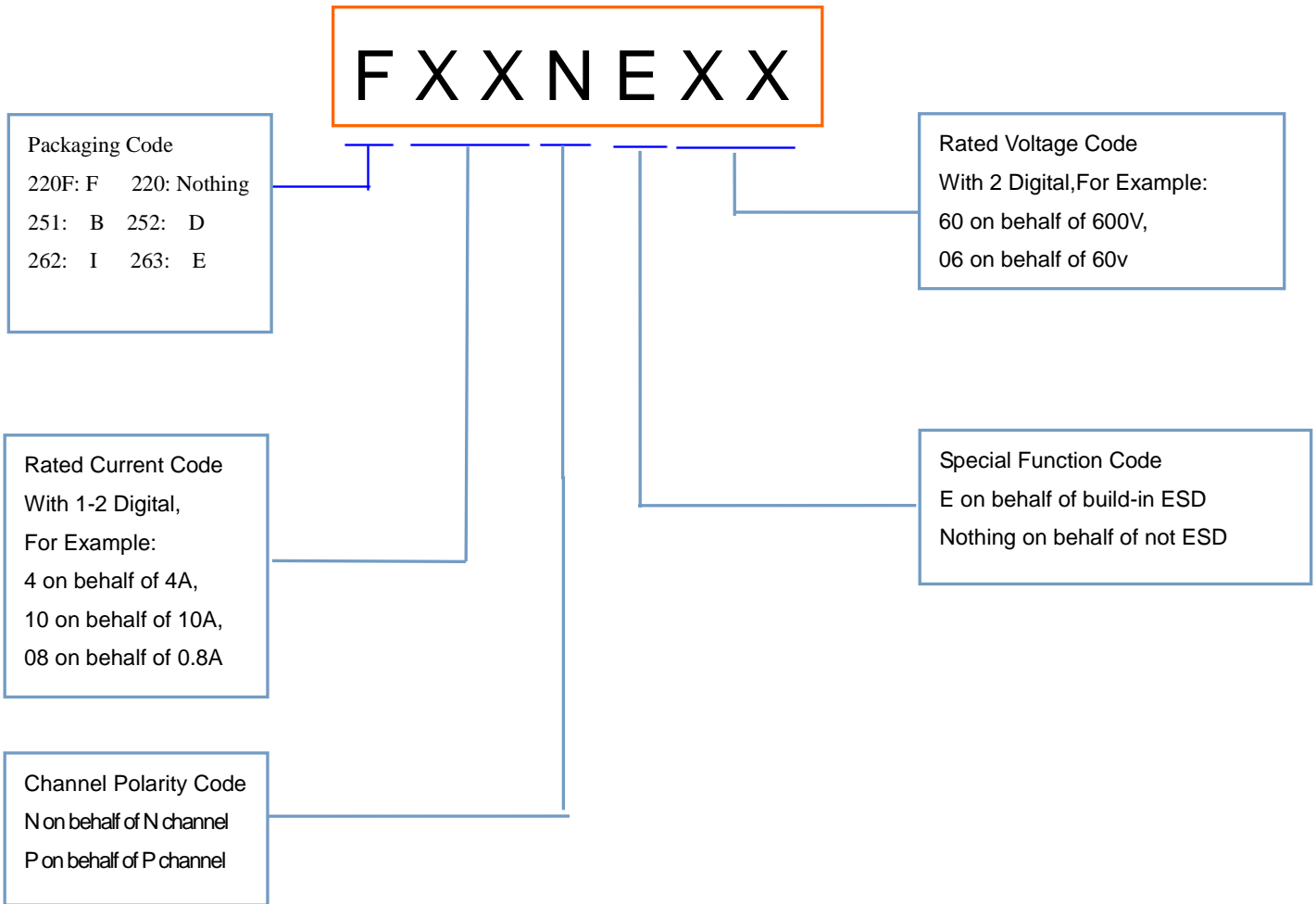

**8 Product Specifications and Packaging Models**

Product Model	Package Type	Mark Name	RoHS	Package	Quantity
7N80	TO-220C	7N80	Pb-free	Tube	1000/box
F7N80	TO-220F	F7N80	Pb-free	Tube	1000/box
I7N80	TO-262	I7N80	Pb-free	Tube	1000/box
E7N80	TO-263	E7N80	Pb-free	Tape & Reel	800/box



**9 Dimensions**

TO-220F PACKAGE OUTLINE DIMENSIONS

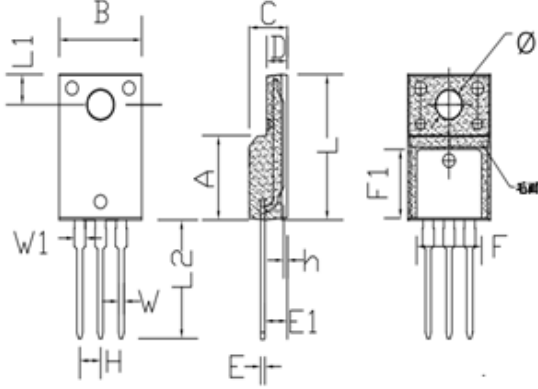

Symbol	Dimensions In Millimeters		Dimensions In Inches	
	min.	max.	min.	max.
A	8.80	9.30	0.346	0.366
B	10.00	10.50	0.394	0.413
C	4.30	4.90	0.169	0.193
D	2.30	2.70	0.091	0.106
L	15.55	16.15	0.612	0.636
h	0.40	0.60	0.016	0.024
L1	3.15	3.55	0.124	0.140
L2	12.65	13.35	0.498	0.526
W	0.70	0.90	0.028	0.035
W1	1.15	1.55	0.045	0.061
H	2.54 TYP		0.100 TYP	
E	0.48	0.53	0.019	0.021
φ	2.90	3.40	0.114	0.134
E1	2.40	2.90	0.094	0.114
F	7.75	8.25	0.305	0.325
F1	7.35	7.85	0.289	0.309

TO-220C PACKAGE OUTLINE DIMENSIONS

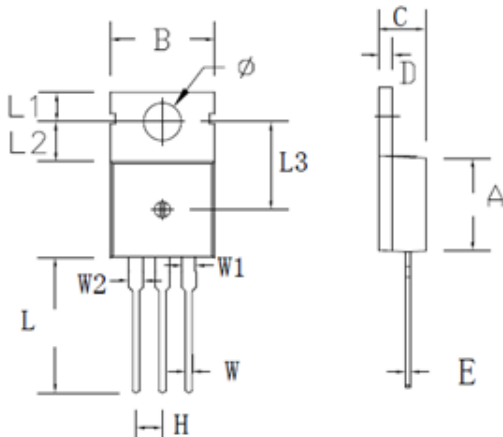

Symbol	Dimensions In Millimeters		Dimensions In Inches	
	min.	max.	min.	max.
A	8.80	9.30	0.346	0.366
B	9.70	10.30	0.382	0.406
C	4.25	4.75	0.167	0.187
D	1.20	1.45	0.047	0.057
E	0.40	0.60	0.016	0.024
H	2.54 TYP		0.100 TYP	
W	0.60	0.95	0.024	0.037
W1	1.05	1.45	0.041	0.057
W2	1.20	1.60	0.047	0.063
L	12.60	13.40	0.496	0.528
L1	2.45	2.95	0.096	0.116
L2	3.45	3.95	0.136	0.156
L3	8.15	8.65	0.321	0.341
φ	3.50	3.90	0.138	0.154

**9 Dimensions(continues)**

TO-262 PACKAGE OUTLINE DIMENSIONS

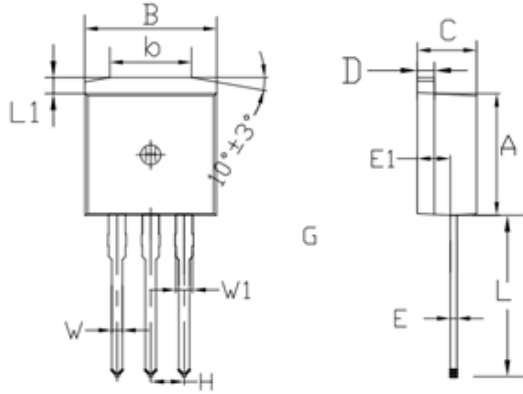

Symbol	Dimensions In Millimeters		Dimensions In Inches	
	min.	max.	min.	max.
A	8.80	9.30	0.346	0.366
B	9.70	10.30	0.382	0.406
C	4.25	4.75	0.167	0.187
D	1.20	1.45	0.047	0.057
E	0.40	0.60	0.016	0.024
L	12.25	13.75	0.482	0.541
L1	1.15	1.45	0.045	0.057
E1	2.4	2.6	0.0945	0.1024
W	0.80	0.82	0.0315	0.034
W1	1.20	1.30	0.047	0.051
H	2.54 TYP		0.200 TYP	
b	5.50	6.50	0.216	0.256

TO-263 PACKAGE OUTLINE DIMENSIONS

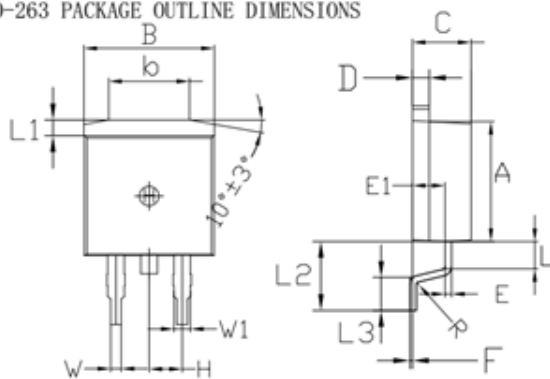

Symbol	Dimensions In Millimeters		Dimensions In Inches	
	min.	max.	min.	max.
A	8.80	9.30	0.346	0.366
B	9.70	10.30	0.382	0.406
C	4.25	4.75	0.167	0.187
D	1.20	1.45	0.047	0.057
E	0.40	0.60	0.016	0.024
L	1.90	2.30	0.075	0.091
L1	1.15	1.45	0.045	0.057
R	0.24	0.26	0.0095	0.0102
W	0.80	0.82	0.0315	0.0323
W1	1.20	1.30	0.047	0.051
H	2.54 TYP		0.200 TYP	
b	5.50	6.50	0.216	0.256
E1	2.4	2.6	0.0946	0.1024
L2	5.20	5.80	0.205	0.228
L3	2.20	3.20	0.087	0.126
F	0.03	0.23	0.0012	0.0091

## 10 Attentions

- ROUM Semiconductor Technology CO.,LTD. reserves the right to change the specification without prior notice! The customer should obtain the latest version of the information before making the order and verify that the information is complete and up to date.
- It is the responsibility of the purchaser for any failure or failure of any semiconductor product under certain conditions. It is the responsibility of the purchaser to comply with safety standards and to take safety measures in the system design and machine manufacturing of Roma products in order to avoid potential risk of failure. Injury or property damage.
- Product promotion is endless, our company will be dedicated to provide customers with better products.

## 11 Appendix

Revision history:

Date	REV.	Description	Page
2017.03.30	1.0	Original	