

## 12A 600V N-channel Enhancement Mode Power MOSFET

### 1 Description

These silicon N-channel Enhanced VDMOSFETs, is obtained by the self-aligned planar technology which reduce the conduction loss, improve switching performance and enhance the avalanche energy. Which accords with the RoHS standard.

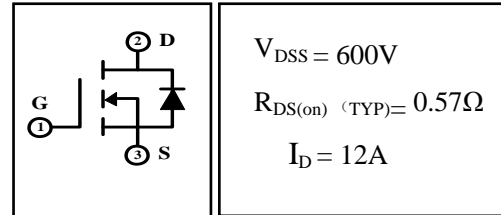

### 2 Features

- Fast Switching
- Low ON Resistance( $R_{dson} \leq 0.75\Omega$ )
- Low Gate Charge(Typical Data:40nC)
- Low Reverse Transfer Capacitances(Typical:10pF)
- 100% Single Pulse Avalanche Energy Test
- 100%  $\Delta V_{DS}$  Test

### 3 Applications

- Used in Various Power Switching Circuit for System Miniaturization and Higher Efficiency.
- Power Switch Circuit of Adaptor and Charger.

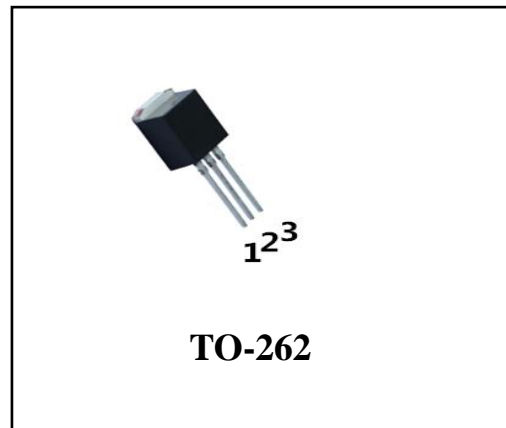

### 4 Electrical Characteristics

#### 4.1 Absolute Maximum Rating ( $T_c=25^\circ C$ , unless otherwise noted)

Parameter	Symbol	Value	Units	
Maximum Drain-Source DC Voltage	$V_{DS}$	600	V	
Maximum Gate-Drain Voltage	$V_{GS}$	$\pm 30$	V	
Drain Current(continuous)	$I_D (T=25^\circ C)$ $(T=100^\circ C)$	12	A	
		7.5	A	
Drain Current(Pulsed) <sup>(Note 3)</sup>	$I_{DM}$	48	A	
Single Pulse Avalanche Energy <sup>(Note 1)</sup>	$E_{AS}$	670	mJ	
Peak Diode Recovery $dv/dt$ <sup>(Note 2)</sup>	$dv/dt$	5	V/ns	
Total Dissipation	$T_a=25^\circ C$	$P_{tot}$	2	W
	$T_C=25^\circ C$	$P_{tot}$	150	W
Junction Temperature	$T_j$	150	$^\circ C$	
Storage Temperature	$T_{stg}$	-55~150	$^\circ C$	
Maximum Temperature for soldering	$T_L$	300	$^\circ C$	

**4.2 Thermal Characteristics**

Parameter	Symbol	Value	Unit
Thermal Resistance Junction to Case-sink	$R_{thJC}$	0.83	°C/W
Thermal Resistance Junction to Ambient	$R_{thJA}$	62.5	°C/W

**4.3 Electrical Characteristics**( $T_C=25^\circ\text{C}$ , unless otherwise noted)

Parameter	Symbol	Test Condition	Value			Units
			Min	Typ	Max	
<b>Off Characteristics</b>						
Drain-source Breakdown Voltage	$BV_{DSS}$	$I_D=250\mu\text{A}, V_{GS}=0\text{V}$	600	--	--	V
Drain-to-Source Leakage Current	$I_{DSS}$	$V_{DS}=600\text{V}, V_{GS}=0\text{V}, T_C=25^\circ\text{C}$	--	--	1	$\mu\text{A}$
		$V_{DS}=480\text{V}, V_{GS}=0\text{V}, T_C=125^\circ\text{C}$	--	--	100	$\mu\text{A}$
Gate-to-Source Forward Leakage	$I_{GSSF}$	$V_{GS}=+30\text{V}$	--	--	100	nA
Gate-to-Source Reverse Leakage	$I_{GSSR}$	$V_{GS}=-30\text{V}$	--	--	-100	nA
<b>On Characteristics</b> <sup>(Note 5)</sup>						
Gate Threshold Voltage	$V_{GS(th)}$	$V_{DS}=V_{GS}, I_D=250\mu\text{A}$	2	--	4	V
Drain-source on Resistance	$R_{DS(on)}$	$V_{GS}=10\text{V}, I_D=6\text{A}$	--	0.57	0.75	$\Omega$
<b>Dynamic Characteristics</b> <sup>(Note 6)</sup>						
Forward Transfer conductance	$g_{fs}$	$V_{DS}=15\text{V}, I_D=6\text{A}$	--	12	--	S
Input Capacitance	$C_{iss}$	$V_{GS}=0\text{V}, V_{DS}=25\text{V}, f=1.0\text{MHz}$	--	1980	--	pF
Output Capacitance	$C_{oss}$		--	170	--	
Reverse Transfer Capacitance	$C_{rss}$		--	10	--	
<b>Switching Characteristics</b> <sup>(note6)</sup>						
Turn-on Delay Time	$t_{d(on)}$	$I_D=12\text{A}, V_{DD}=300\text{V}, R_G=10\Omega$	--	27	--	nS
Turn-on Rise Time	$t_r$		--	25	--	nS
Turn-off Delay Time	$t_{d(off)}$		--	63	--	nS
Turn-off Fall Time	$t_f$		--	39	--	nS
Total Gate Charge	$Q_g$	$I_D=12\text{A}, V_{DD}=480\text{V}, V_{GS}=10\text{V}$	--	40	--	nC
Gate-to-Source Charge	$Q_{gs}$		--	9.8	--	
Gate-to-Drain("Miller") Charge	$Q_{gd}$		--	14.5	--	
<b>Drain-Source Diode Characteristics</b>						
Diode Forward Voltage <sup>(Note 3)</sup>	$V_{FSD}$	$V_{GS}=0\text{V}, I_S=12\text{A}$	--	--	1.5	V
Diode Forward Current <sup>(Note 2)</sup>	$I_S$		--	--	12	A

Reverse Recovery Time	$t_{rr}$	$T_j=25^{\circ}\text{C}, I_S=12\text{A},$ $dI_F/dt=100\text{A}/\mu\text{S}, V_{GS}=0\text{V}$	--	581	--	nS
Reverse Recovery Charge	$Q_{rr}$		--	4009	--	nC
Reverse Recovery Current	$I_{RRM}$		--	13.8	--	A

**Notes:**

1.  $L=10\text{mH}, I_D=11.6\text{A}$ , Start  $T_j=25^{\circ}\text{C}$ .
2.  $I_{SD}=12\text{A}, di/dt \leq 100\text{A}/\mu\text{s}, V_{DD} \leq BV_{DSS}$ , Start  $T_j=25^{\circ}\text{C}$ .
- 3: Repetitive rating, pulse width limited by maximum junction temperature.
- 4: Surface mounted on FR4 Board,  $t \leq 10\text{sec}$ .
- 5: Pulse width  $\leq 300\mu\text{s}$ , duty cycle  $\leq 2\%$ .
- 6: Guaranteed by design, not subject to production.

**5 Typical characteristics diagrams**

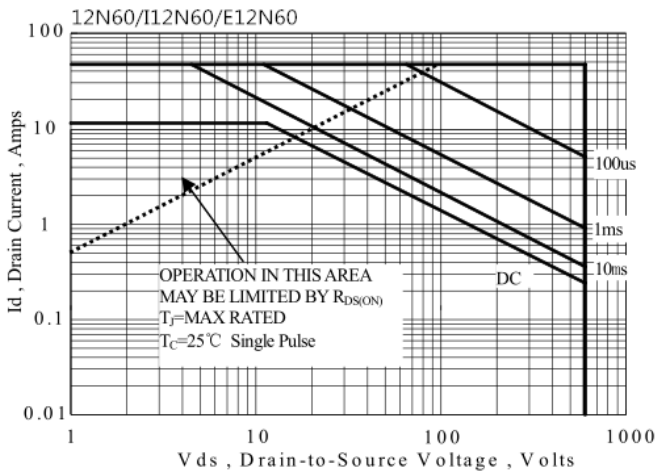

Figure 1 Maximum Forward Bias Safe Operating Area

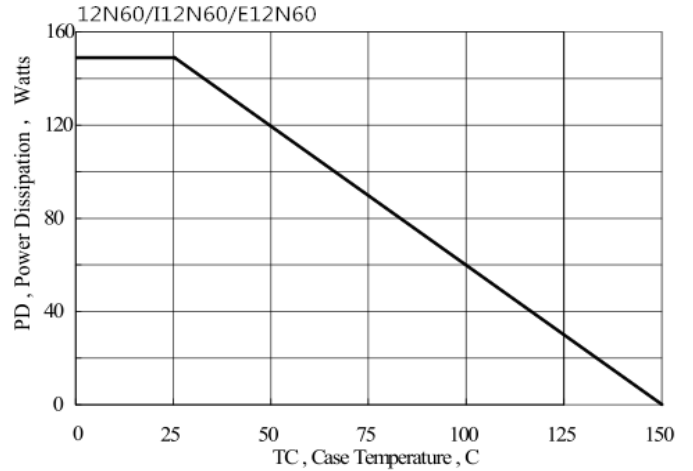

Figure 2 Maximum Power Dissipation vs Case Temperature

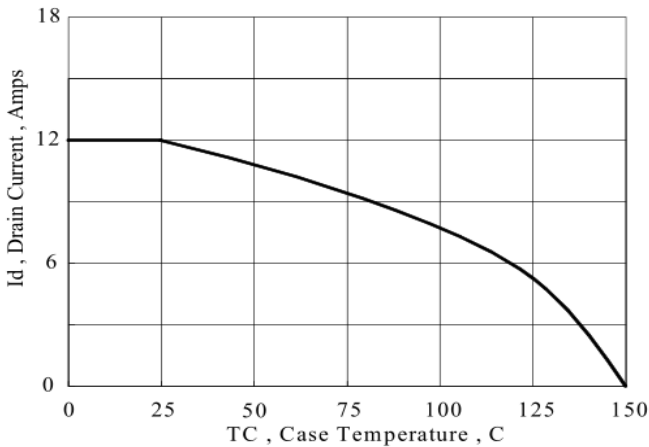

Figure 3 Maximum Continuous Drain Current vs Case Temperature

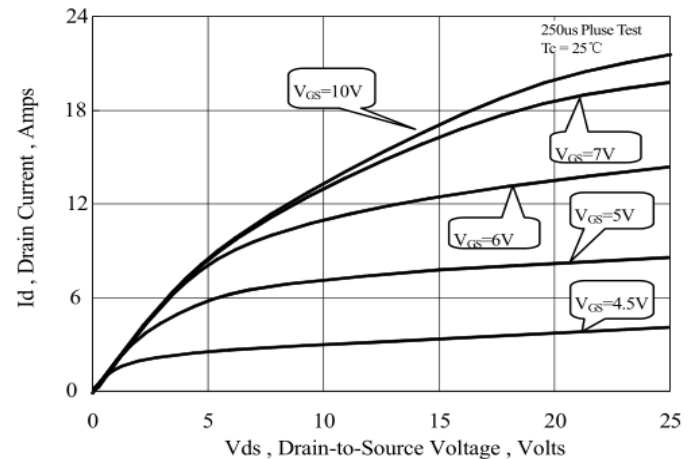

Figure 4 Typical Output Characteristics

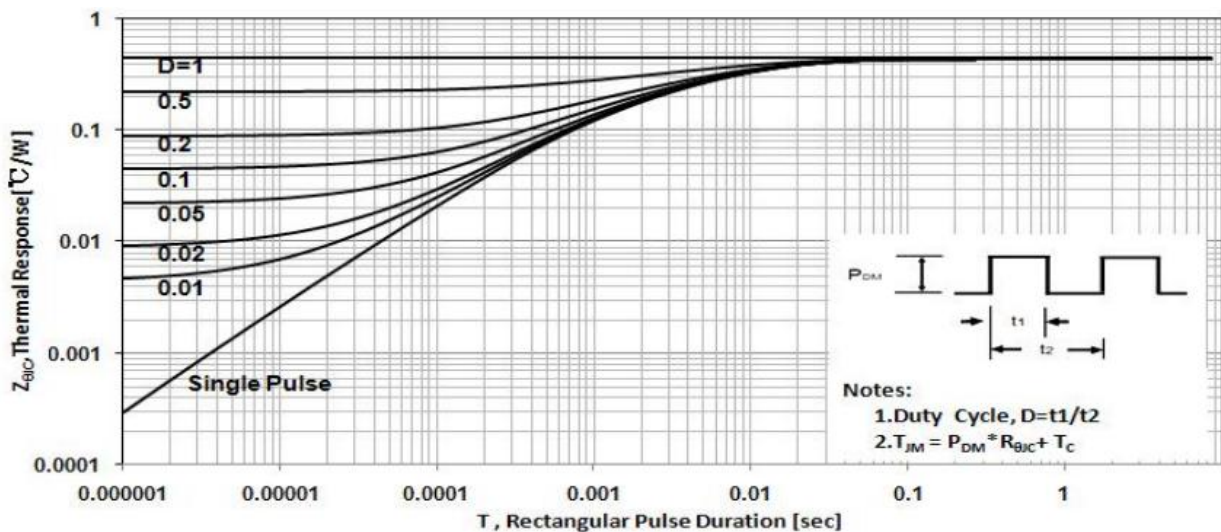

Figure 5 Maximum Effective Thermal Impedance, Junction to Case

**5 Typical characteristics diagrams(continues)**

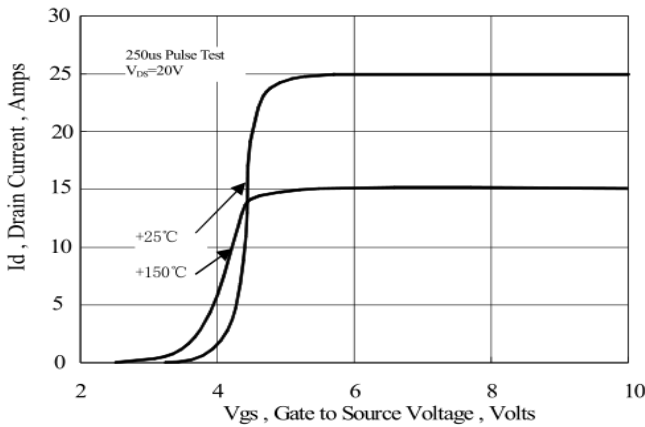

Figure 6 Typical Transfer Characteristics

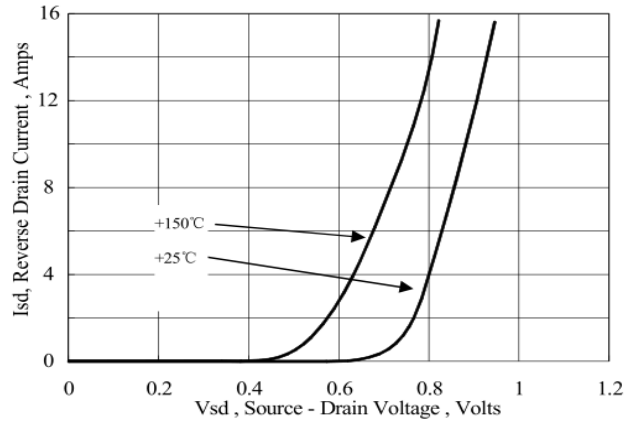

Figure 7 Typical Body Diode Transfer Characteristics

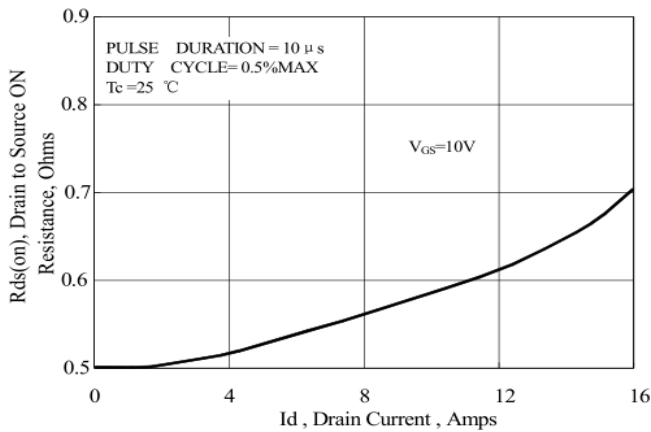

Figure 8 Typical Drain to Source ON Resistance vs Drain Current

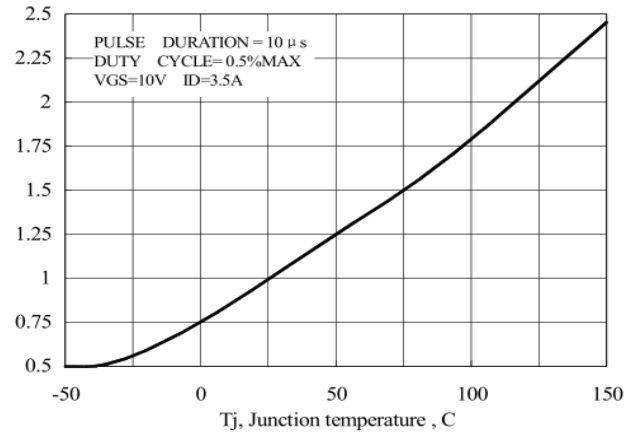

Figure 9 Typical Drain to Source on Resistance vs Junction Temperature

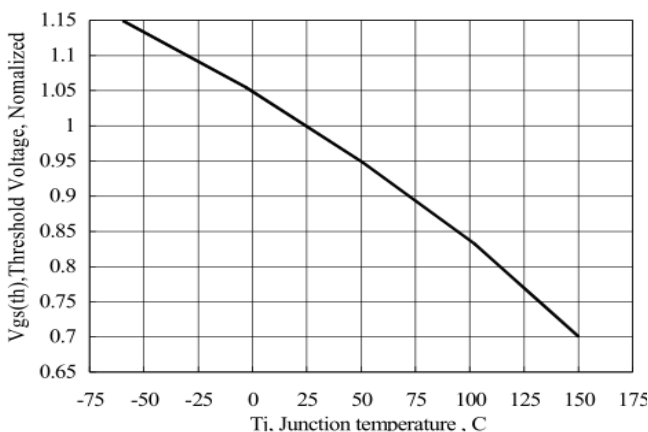

Figure 10 Typical Threshold Voltage vs Junction Temperature

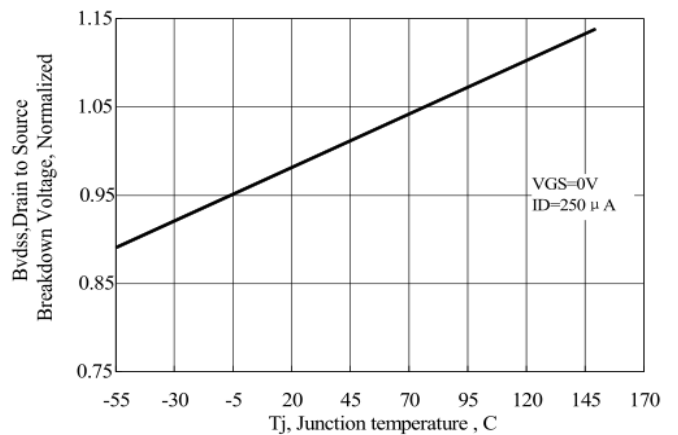

Figure 11 Typical Breakdown Voltage vs Junction Temperature

**5 Typical characteristics diagrams(continues)**

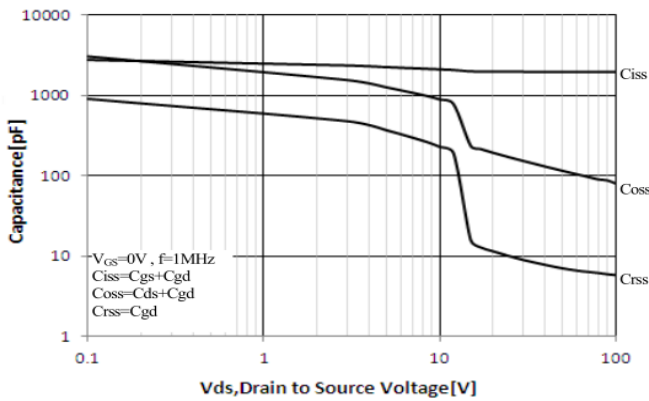

Figure 12 Typical Capacitance vs Drain to Source Voltage

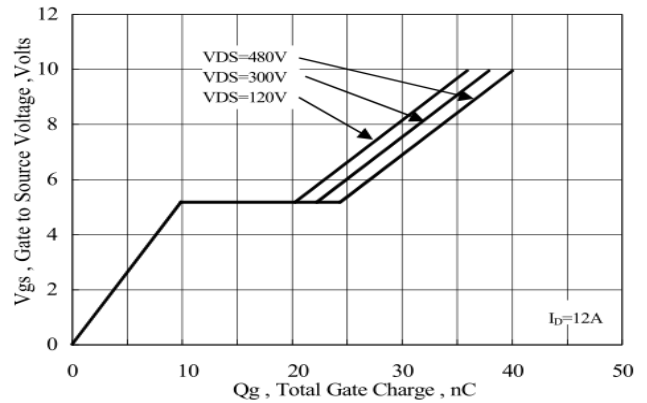

Figure 13 Typical Gate Charge vs Gate to Source Voltage

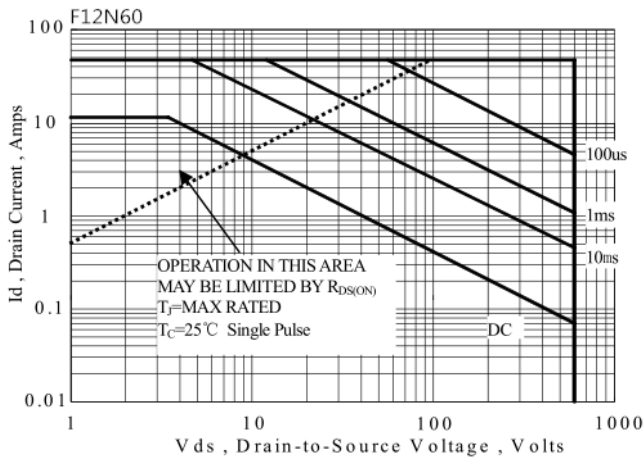

Figure 14 Maximum Forward Bias Safe Operating Area

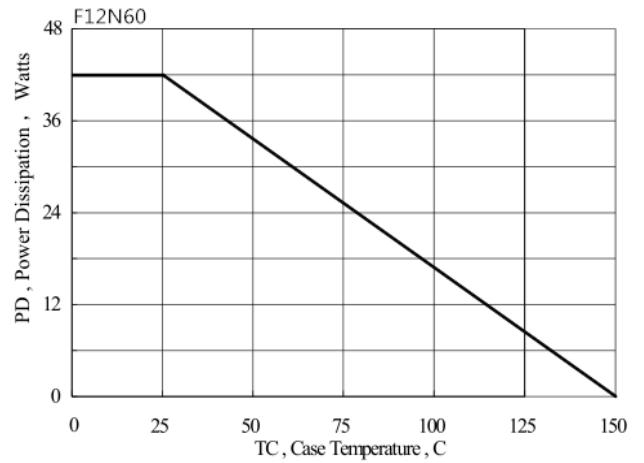
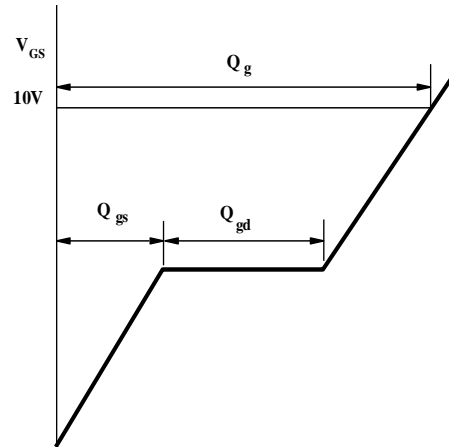
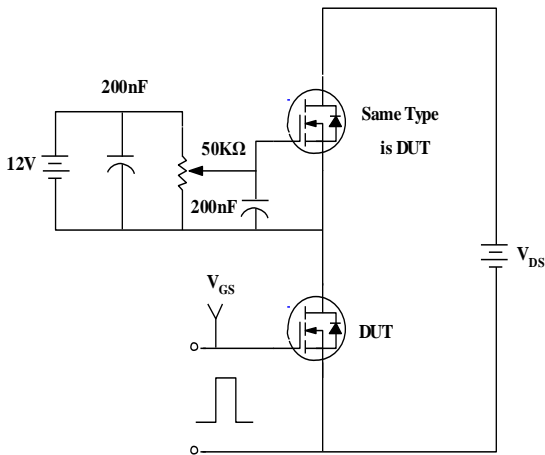
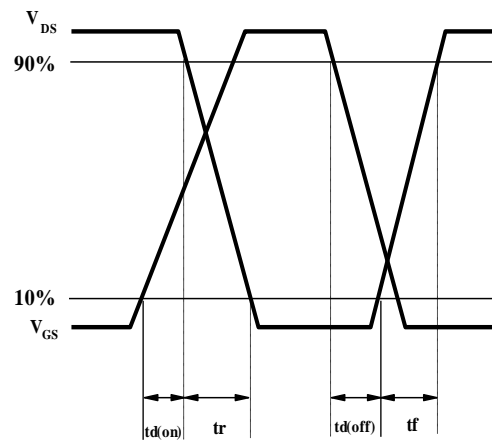
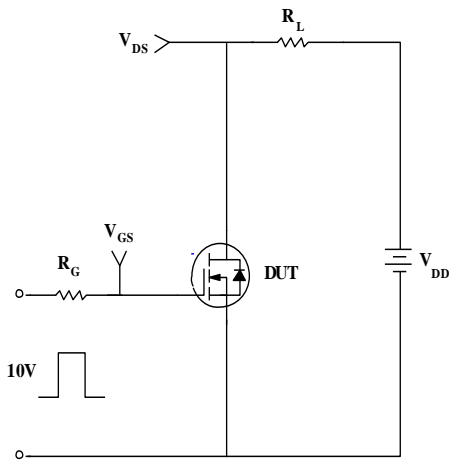

Figure 15 Maximum Power Dissipation vs Case Temperature

**6 Typical Test Circuit and Waveform**



**1) Gate Charge Test Circuit & Waveform**



**2) Resistive Switching Test Circuit & Waveforms**

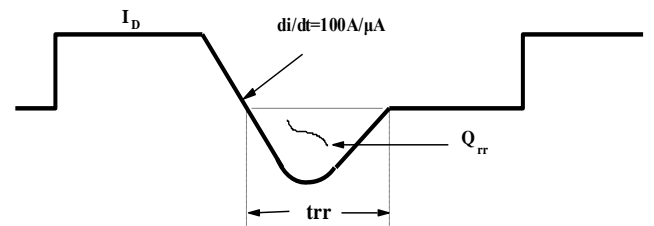
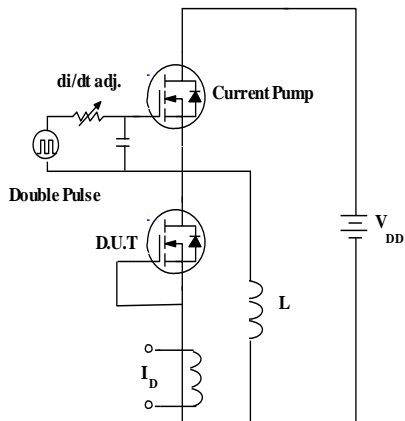

**3) Diode Reverse Recovery Test Circuit & Waveform**

**6 Typical Test Circuit and Waveform(continues)**

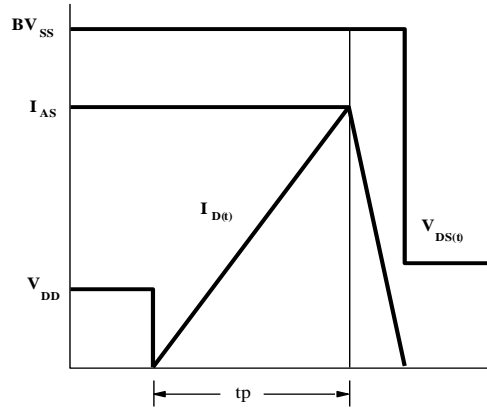
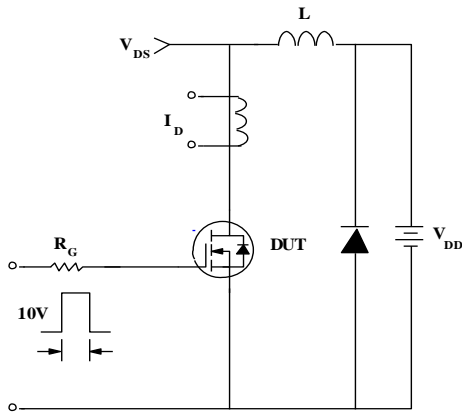

**4) Unclamped Inductive Switching Test Circuit & Waveforms**

**7 Product Names Rules**

**F X X N E X X**

**Packaging Code**  
 220F: F    220: Nothing  
 251: B    252: D  
 262: I    263: E

**Rated Voltage Code**  
 With 2 Digital, For Example:  
 60 on behalf of 600V,  
 06 on behalf of 60v

**Rated Current Code**  
 With 1-2 Digital,  
 For Example:  
 4 on behalf of 4A,  
 10 on behalf of 10A,  
 08 on behalf of 0.8A

**Special Function Code**  
 E on behalf of build-in ESD  
 Nothing on behalf of not ESD

**Channel Polarity Code**  
 N on behalf of N channel  
 P on behalf of P channel



## 8 Product Specifications and Packaging Models

Product Model	Package Type	Mark Name	RoHS	Package	Quantity
12N60	TO-220C	12N60	Pb-free	Tube	1000/box
F12N60	TO-220F	F12N60	Pb-free	Tube	1000/box
I12N60	TO-262	I12N60	Pb-free	Tube	1000/box
E12N60	TO-263	E12N60	Pb-free	Tape & Reel	800/box

## 9 Dimensions

TO-262 PACKAGE OUTLINE DIMENSIONS

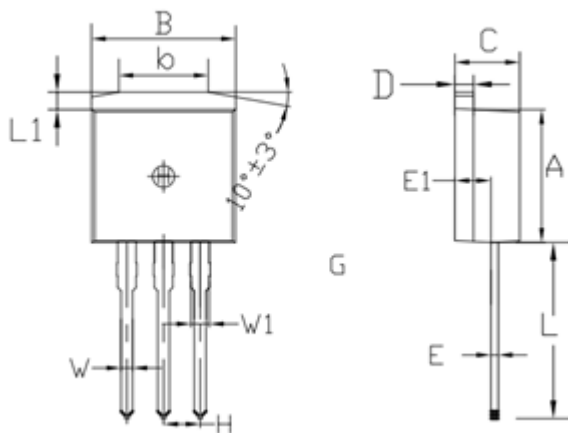

Symbol	Dimensions In Millimeters		Dimensions In Inches	
	min.	max.	min.	max.
A	8.80	9.30	0.346	0.366
B	9.70	10.30	0.382	0.406
C	4.25	4.75	0.167	0.187
D	1.20	1.45	0.047	0.057
E	0.40	0.60	0.016	0.024
L	12.25	13.75	0.482	0.541
L1	1.15	1.45	0.045	0.057
E1	2.4	2.6	0.0945	0.1024
W	0.80	0.82	0.0315	0.034
W1	1.20	1.30	0.047	0.051
H	2.54 TYP		0.200 TYP	
b	5.50	6.50	0.216	0.256

TO-263 PACKAGE OUTLINE DIMENSIONS

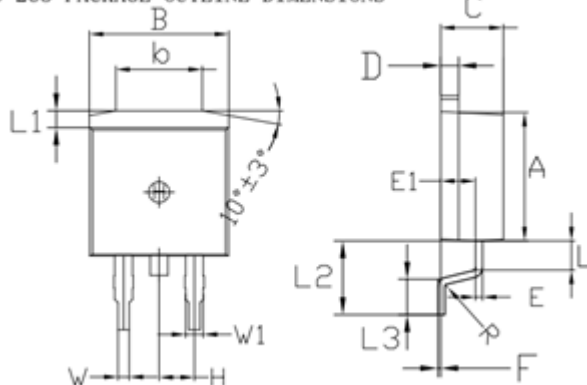

Symbol	Dimensions In Millimeters		Dimensions In Inches	
	min.	max.	min.	max.
A	8.80	9.30	0.346	0.366
B	9.70	10.30	0.382	0.406
C	4.25	4.75	0.167	0.187
D	1.20	1.45	0.047	0.057
E	0.40	0.60	0.016	0.024
L	1.90	2.30	0.075	0.091
L1	1.15	1.45	0.045	0.057
R	0.24	0.26	0.0095	0.0102
W	0.80	0.82	0.0315	0.0323
W1	1.20	1.30	0.047	0.051
H	2.54 TYP		0.200 TYP	
b	5.50	6.50	0.216	0.256
E1	2.4	2.6	0.0946	0.1024
L2	5.20	5.80	0.205	0.228
L3	2.20	3.20	0.087	0.126
F	0.03	0.23	0.0012	0.0091

9 Dimensions(continues)

TO-220F PACKAGE OUTLINE DIMENSIONS

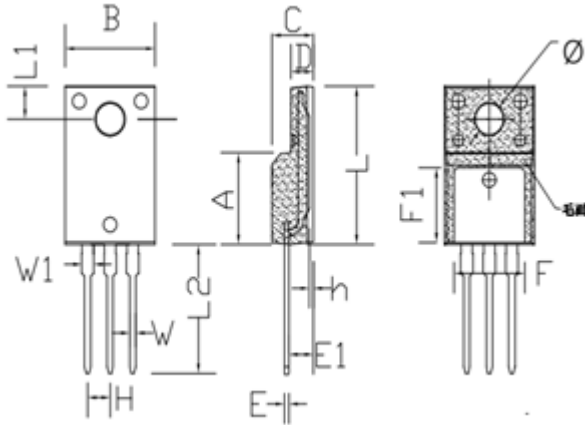

Symbol	Dimensions In Millimeters		Dimensions In Inches	
	min.	max.	min.	max.
A	8.80	9.30	0.346	0.366
B	10.00	10.50	0.394	0.413
C	4.30	4.90	0.169	0.193
D	2.30	2.70	0.091	0.106
L	15.55	16.15	0.612	0.636
h	0.40	0.60	0.016	0.024
L1	3.15	3.55	0.124	0.140
L2	12.65	13.35	0.498	0.526
W	0.70	0.90	0.028	0.035
W1	1.15	1.55	0.045	0.061
H	2.54 TYP		0.100 TYP	
E	0.48	0.53	0.019	0.021
$\phi$	2.90	3.40	0.114	0.134
E1	2.40	2.90	0.094	0.114
F	7.75	8.25	0.305	0.325
F1	7.35	7.85	0.289	0.309

TO-220C PACKAGE OUTLINE DIMENSIONS

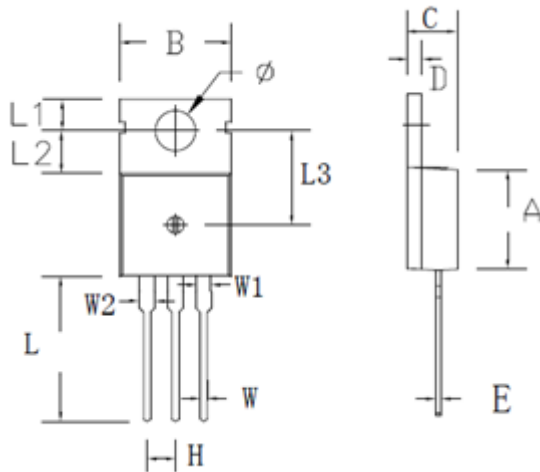

Symbol	Dimensions In Millimeters		Dimensions In Inches	
	min.	max.	min.	max.
A	8.80	9.30	0.346	0.366
B	9.70	10.30	0.382	0.406
C	4.25	4.75	0.167	0.187
D	1.20	1.45	0.047	0.057
E	0.40	0.60	0.016	0.024
H	2.54 TYP		0.100 TYP	
W	0.60	0.95	0.024	0.037
W1	1.05	1.45	0.041	0.057
W2	1.20	1.60	0.047	0.063
L	12.60	13.40	0.496	0.528
L1	2.45	2.95	0.096	0.116
L2	3.45	3.95	0.136	0.156
L3	8.15	8.65	0.321	0.341
$\phi$	3.50	3.90	0.138	0.154

## 10 Attentions

- ROUM Semiconductor Technology CO.,LTD. reserves the right to change the specification without prior notice! The customer should obtain the latest version of the information before making the order and verify that the information is complete and up to date.
- It is the responsibility of the purchaser for any failure or failure of any semiconductor product under certain conditions. It is the responsibility of the purchaser to comply with safety standards and to take safety measures in the system design and machine manufacturing of Roma products in order to avoid potential risk of failure. Injury or property damage.
- Product promotion is endless, our company will be dedicated to provide customers with better products.

## 11 Appendix

Revision history:

Date	REV.	Description	Page
2017.04.10	1.0	Original	