

Features

- 300KHz Constant Switching Frequency
- VBAT Rang= 4.5V~13.2V
- Support 0.6V Internal Reference Voltage
- 0-80% Duty Cycle
- Soft-Start Circuit Built-In
- Short Circuit Protection
- Under Voltage Protection and Over Voltage Protection
- Flexible Over Current Protection Setting
- Thermal Fault Protection
- Integrated Bootstrap Diode
- PSOP-8 package
- Green Product (RoHS, Lead-Free, Halogen-Free Compliant)

General Description

The GS72V3 is a single buck controller working in a voltage mode with fixed 300 kHz frequency. It allows wide input voltage which is either a single 5~12V or two supply voltages for various applications, and the output voltage can be precisely regulated to as low as 0.6V with a maximum tolerance of $\pm 1.0\%$.

The GS72V3 is equipped with accurate current-limit, under-voltage output and over-voltage output protections. Otherwise, It includes internal soft-start and built-in bootstrap diode to simplify the circuit design.

The GS72V3 is available in a simple PSOP-8 Package.

Applications

- Mother Board
- Graphic cards
- Cable Modems, Set Top Boxes, and Xdsl Supplies
- Low cost PC

Typical Application

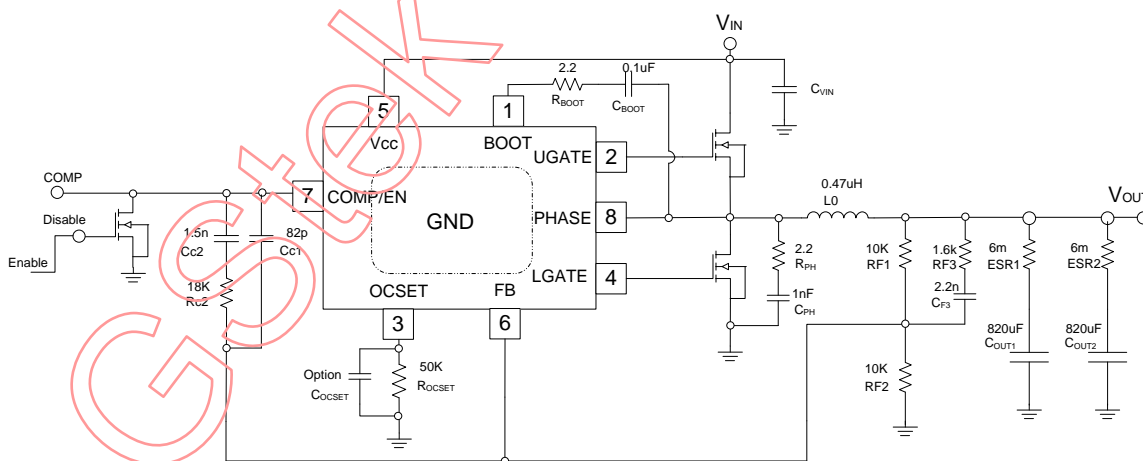

Figure 1 Typical Application of GS72V3

This document is GStek's confidential information. Anyone having confidential obligation to GStek shall keep this document confidential. Any unauthorized disclosure or use beyond authorized purpose will be considered as violation of confidentiality and criminal and civil liability will be asserted.