

**PRODUCT SUMMARY**

$V_{(BR)DSS}$	$R_{DS(ON)}$	$I_D$
-30V	4.1mΩ	-83A

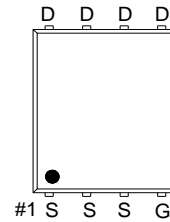
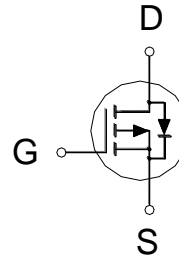

G. GATE  
D. DRAIN  
S. SOURCE

100% UIS Tested  
100% Rg Tested

**Features**

- Pb-Free, Halogen Free and RoHS compliant.
- Low  $R_{DS(on)}$  to Minimize Conduction Losses.
- Ohmic Region Good  $R_{DS(on)}$  Ratio.
- Optimized Gate Charge to Minimize Switching Losses.

**Applications**

- Protection Circuits Applications.
- Logic/Load Switch Circuits Applications.

**ABSOLUTE MAXIMUM RATINGS ( $T_A = 25\text{ °C}$  Unless Otherwise Noted)**

PARAMETERS/TEST CONDITIONS		SYMBOL	LIMITS	UNITS
Drain-Source Voltage		$V_{DS}$	-30	V
Gate-Source Voltage		$V_{GS}$	±25	V
Continuous Drain Current <sup>4</sup>	$T_C = 25\text{ °C}$	$I_D$	-83	A
	$T_C = 100\text{ °C}$		-52	
	$T_A = 25\text{ °C}$		-23	
	$T_A = 70\text{ °C}$		-18	
Pulsed Drain Current <sup>1</sup>		$I_{DM}$	-160	
Avalanche Current		$I_{AS}$	-60.5	
Avalanche Energy	$L = 0.1\text{mH}$	$E_{AS}$	183	mJ
Power Dissipation <sup>3</sup>	$T_C = 25\text{ °C}$	$P_D$	54	W
	$T_C = 100\text{ °C}$		21	
	$T_A = 25\text{ °C}$		4.1	
	$T_A = 70\text{ °C}$		2.6	
Operating Junction & Storage Temperature Range		$T_j, T_{stg}$	-55 to 150	°C

**THERMAL RESISTANCE RATINGS**

THERMAL RESISTANCE		SYMBOL	TYPICAL	MAXIMUM	UNITS
Junction-to-Ambient <sup>2</sup>	$t \leq 10s$	$R_{\theta JA}$		30	°C / W
Junction-to-Ambient <sup>2</sup>	Steady-State	$R_{\theta JA}$		51	
Junction-to-Case	Steady-State	$R_{\theta JC}$		2.3	

<sup>1</sup>Pulse width limited by maximum junction temperature.

<sup>2</sup>The value of  $R_{\theta JA}$  is measured with the device mounted on 1in<sup>2</sup> FR-4 board with 2oz. Copper, in a still air environment with  $T_A = 25^\circ C$ . The value in any given application depends on the user's specific board design.

<sup>3</sup>The Power dissipation is based on  $R_{\theta JA} t \leq 10s$  value.

<sup>4</sup>Package limitation current is -51A.

**ELECTRICAL CHARACTERISTICS ( $T_J = 25^\circ C$ , Unless Otherwise Noted)**

PARAMETER	SYMBOL	TEST CONDITIONS	LIMITS			UNIT
			MIN	TYP	MAX	
<b>STATIC</b>						
Drain-Source Breakdown Voltage	$V_{(BR)DSS}$	$V_{GS} = 0V, I_D = -250\mu A$	-30			V
Gate Threshold Voltage	$V_{GS(th)}$	$V_{DS} = V_{GS}, I_D = -250\mu A$	-1.3	-1.8	-2.3	
Gate-Body Leakage	$I_{GSS}$	$V_{DS} = 0V, V_{GS} = \pm 25V$			$\pm 100$	nA
Zero Gate Voltage Drain Current	$I_{DSS}$	$V_{DS} = -24V, V_{GS} = 0V$			-1	uA
		$V_{DS} = -20V, V_{GS} = 0V, T_J = 125^\circ C$			-10	
Drain-Source On-State Resistance <sup>1</sup>	$R_{DS(ON)}$	$V_{GS} = -10V, I_D = -12A$		2.8	4.1	mΩ
		$V_{GS} = -4.5V, I_D = -12A$		4.1	6.2	
Forward Transconductance <sup>1</sup>	$g_{fs}$	$V_{DS} = -5V, I_D = -12A$		60		S
<b>DYNAMIC</b>						
Input Capacitance	$C_{iss}$	$V_{GS} = 0V, V_{DS} = -15V, f = 1MHz$		6550		pF
Output Capacitance	$C_{oss}$			1053		
Reverse Transfer Capacitance	$C_{rss}$			863		
Gate Resistance	$R_g$	$V_{GS} = 0V, V_{DS} = 0V, f = 1MHz$		3.9		Ω
Total Gate Charge <sup>2</sup>	$Q_g$	$V_{DS} = -15V,$ $V_{GS} = -10V, I_D = -12A$		143		nC
Gate-Source Charge <sup>2</sup>	$Q_{gs}$			17		
Gate-Drain Charge <sup>2</sup>	$Q_{gd}$			33		
Turn-On Delay Time <sup>2</sup>	$t_{d(on)}$	$I_D \cong -12A, V_{GS} = -10V, R_{GS} = 6\Omega$		21		nS
Rise Time <sup>2</sup>	$t_r$			37		
Turn-Off Delay Time <sup>2</sup>	$t_{d(off)}$			290		
Fall Time <sup>2</sup>	$t_f$			145		

**SOURCE-DRAIN DIODE RATINGS AND CHARACTERISTICS (T<sub>J</sub> = 25 °C)**

Continuous Current <sup>3</sup>	I <sub>S</sub>				-41	A
Forward Voltage <sup>1</sup>	V <sub>SD</sub>	I <sub>F</sub> = -12A, V <sub>GS</sub> = 0V			-1.3	V
Reverse Recovery Time	t <sub>rr</sub>	I <sub>F</sub> = -12A , di <sub>F</sub> /dt = 100 A / μS		45		nS
Reverse Recovery Charge	Q <sub>rr</sub>			31		nC

<sup>1</sup>Pulse test : Pulse Width ≤ 300 μsec, Duty Cycle ≤ 2%.

<sup>2</sup>Independent of operating temperature.

<sup>3</sup>Package limitation current is -51A.

**Output Characteristics**

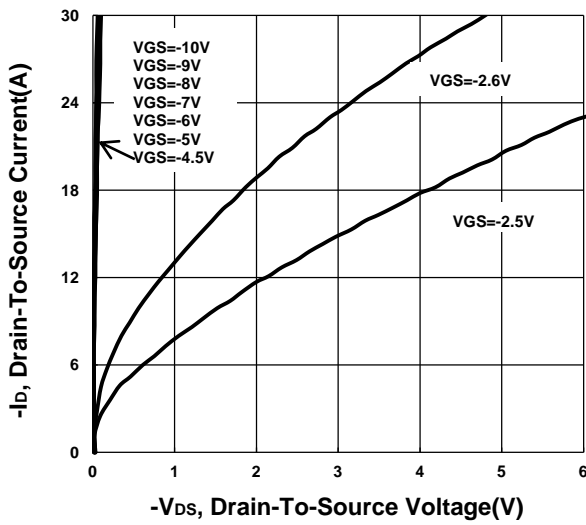

**Transfer Characteristics**

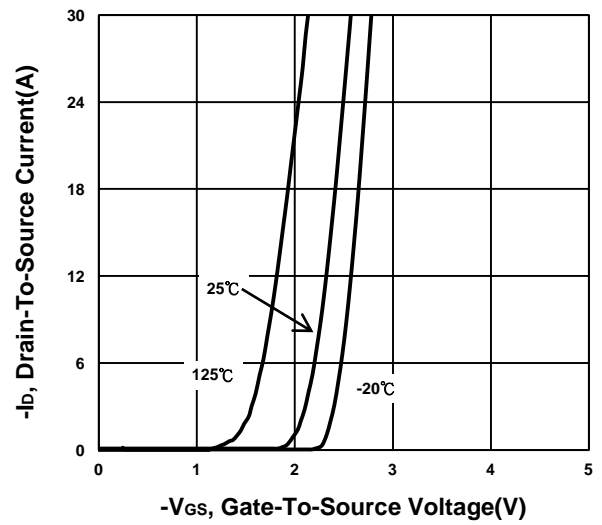

**Gate charge Characteristics**

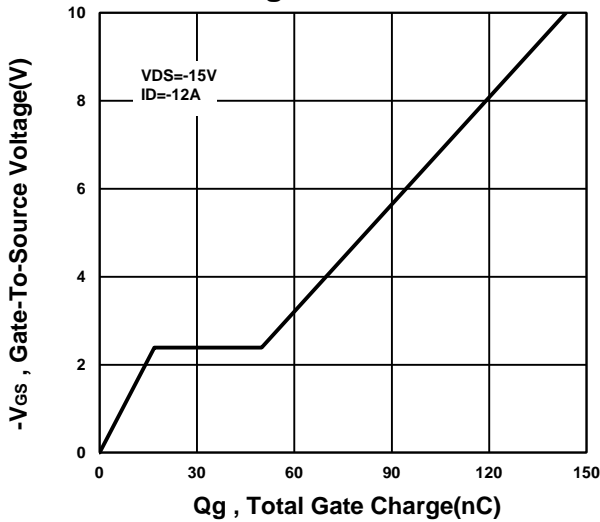

**Capacitance Characteristic**

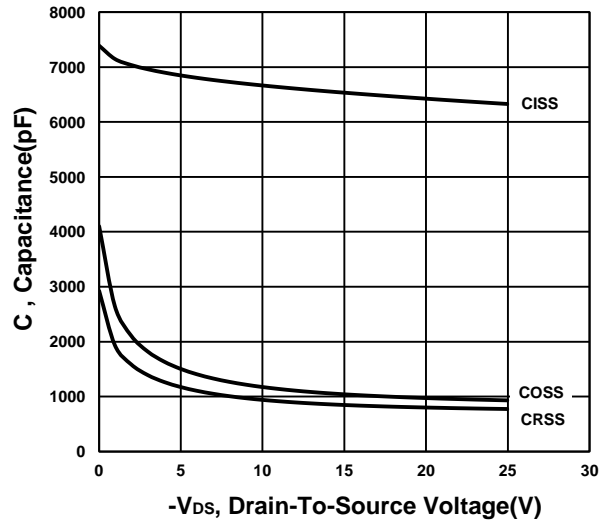

**On-Resistance VS Gate-To-Source**

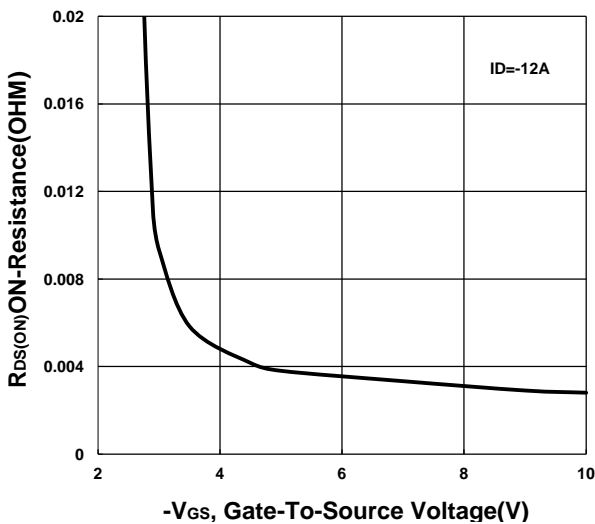

**On-Resistance VS Drain Current**

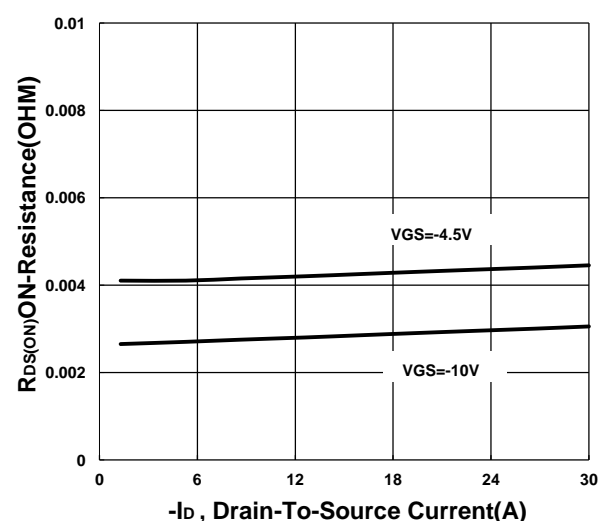

**On-Resistance VS Temperature**

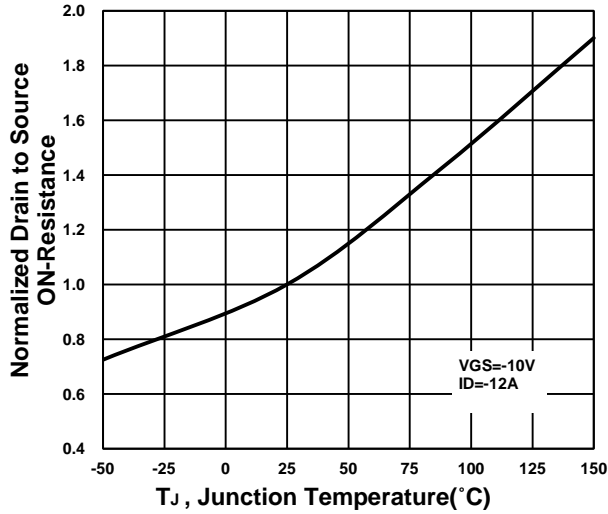

**Source-Drain Diode Forward Voltage**

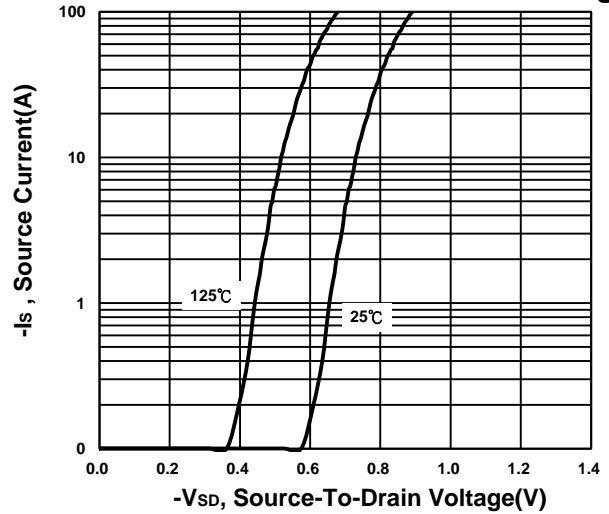

**Safe Operating Area**

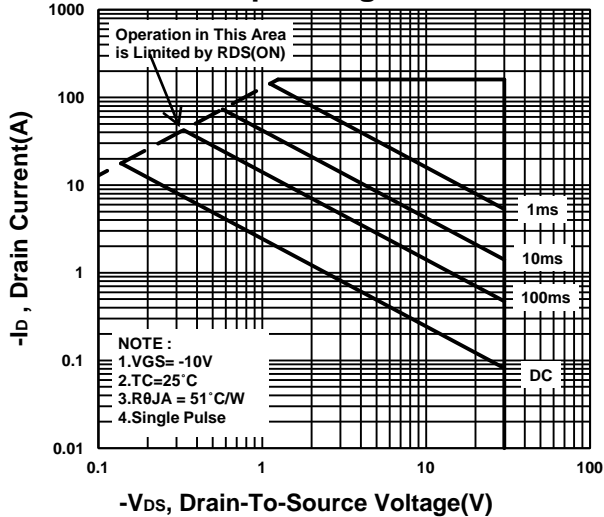

**Single Pulse Maximum Power Dissipation**

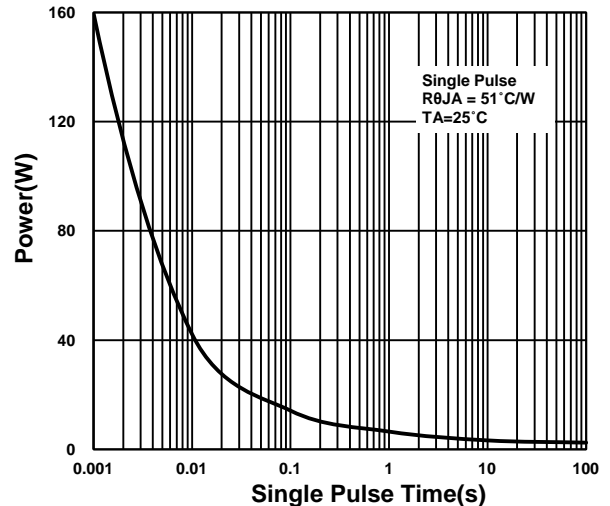

**Transient Thermal Response Curve**

