

600mA Low Dropout Linear Regulator

Description

The FP6130 is a low dropout and positive linear regulator with very low quiescent current. The FP6130 can supply 600mA output current with a low dropout voltage at about 600mV.

The FP6130 regulator is able to operate with output capacitors as small as 1 μ F for stability. The FP6130 also offers on chip thermal shutdown feature to provide protection against overload or any condition when the ambient temperature exceeds the junction temperature.

The FP6130 is available in space-saving SOT-223 package.

Features

- Low Dropout Voltage of 600mV at 600mA
- Guaranteed 600mA Output Current
- Very Low Quiescent Current at about 30 μ A
- Max. \pm 2% Output Accuracy
- Needs Only 1 μ F Capacitor for Stability
- Thermal Shutdown Protection
- Current Limit Protection
- Low-ESR Ceramic Capacitor for Output Stability
- RoHS Compliant

Applications

- DVD/CD-ROM, CD/RW
- Wireless Device
- LCD Module
- Battery Power System
- Card Reader
- XDSL Router

Pin Assignments

IR3 Package (SOT-223)

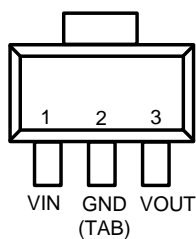

GR3 Package (SOT-223)

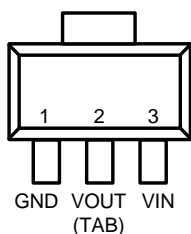
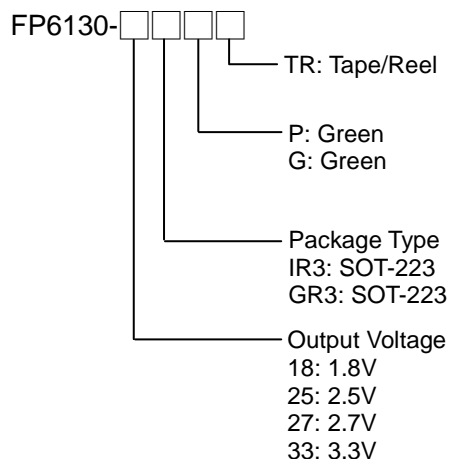

Figure 1. Pin Assignment of FP6130

Ordering Information



Note 1 : Please consult Fitipower sales office or authorized distributor for availability of special output voltages.

Typical Application Circuit

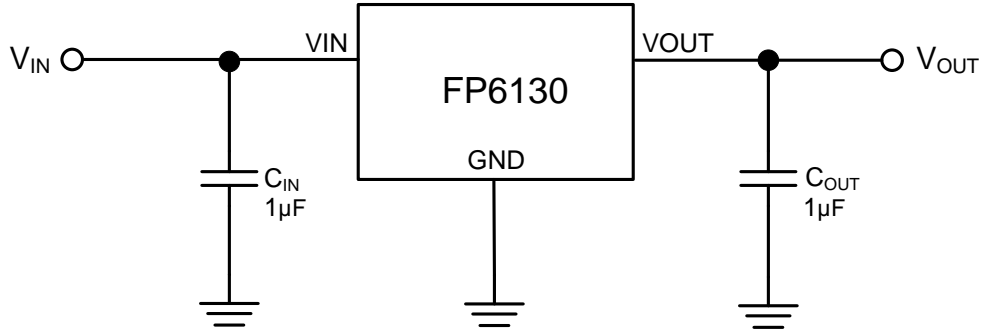

Figure 2. Typical Application Circuit of FP6130

Note 2 : To prevent oscillation, it is recommended to use minimum 1μF X7R or X5R dielectric capacitors if ceramics are used as input/output capacitors.

Functional Pin Description

Pin Name	Pin Function
VIN	Power is supplied to this device from this pin which requires an input filter capacitor. In general, the input capacitor in the range of 1μF to 10μF is sufficient.
VOUT	The output supplies power to loads. The output capacitor is required to prevent output voltage unstable. The FP6130 is stable with an output capacitor 1μF or greater. The larger output capacitor will be required for application with large transit load to limit peak voltage transits. Besides, it could reduce output noise, improve stability and PSRR.
GND	Common ground pin

Block Diagram

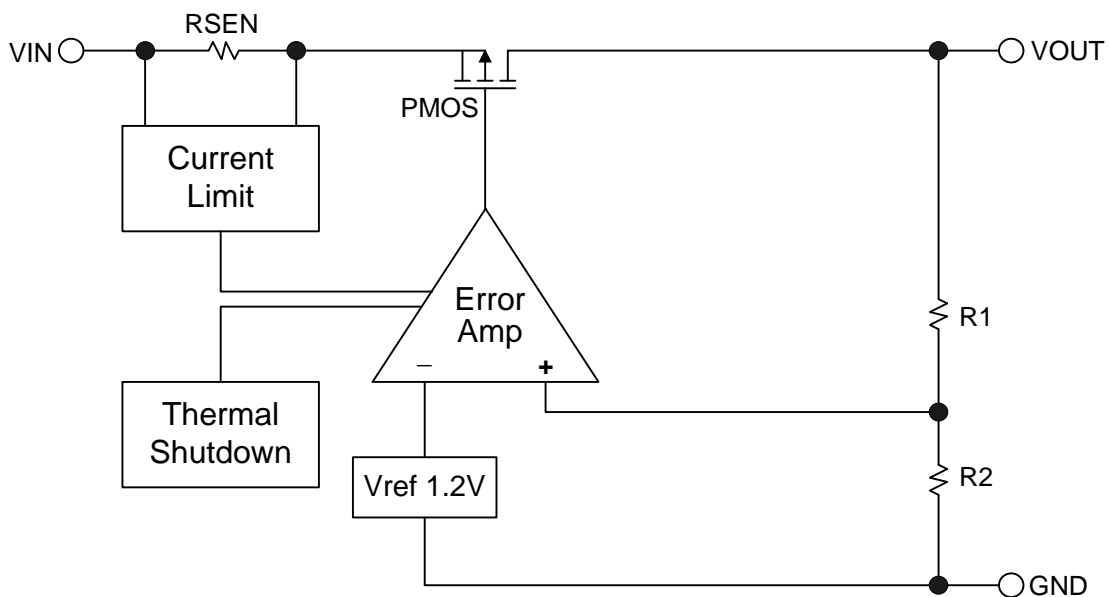

Figure 3. Block Diagram of FP6130

Absolute Maximum Ratings

- Supply Input Voltage (V_{IN}) ----- +6V
- Power Dissipation @25°C, SOT-223 (P_D) ----- +0.74W
- Package Thermal Resistance, SOT-223 (θ_{JA}) ----- +135°C/W
- Maximum Junction Temperature (T_J) ----- +150°C
- Storage Temperature Range (T_S) ----- -65°C to +150°C
- Lead Temperature (Soldering, 10 sec.) (T_{LEAD}) ----- +260°C

Note 3 : Stresses beyond those listed under "Absolute Maximum Ratings" may cause permanent damage to the device.

Recommended Operating Conditions

- Input Voltage (V_{IN}) ----- +2.8V to +5.5V
- Operating Temperature Range (T_{OPR}) ----- -40°C to +85°C

Electrical Characteristics

($V_{IN}=V_{OUT}+1V$ or $V_{IN}=2.8V$ whichever is greater, $C_{IN}=1\mu F$, $C_{OUT}=1\mu F$, $T_A=25^\circ C$, unless otherwise specified)

Parameter	Symbol	Conditions	Min	Typ	Max	Unit	
Output Voltage Accuracy	ΔV_{OUT}	$I_O = 1mA$	-2		+2	%	
Current Limit	I_{LIMIT}	$R_{Load}=1\Omega$	600			mA	
Quiescent Current	I_Q	$I_O = 0mA$		30	50	μA	
Dropout Voltage (Note4)	V_{DROP}	$I_O=600mA$	$V_{OUT}=1.5V$		1550	1690	mV
			$V_{OUT}=1.8V$		1300	1420	
			$V_{OUT}=2.5V$		800	900	
			$V_{OUT}=3.0V$		650	730	
			$V_{OUT}=3.3V$		600	670	
Line Regulation	ΔV_{LINE}	$I_O=1mA, V_{IN}=V_{OUT} +1V$ to 5V		1	5	mV	
Load Regulation (Note5)	ΔV_{LOAD}	$I_O=0mA$ to 600mA		13	50	mV	
Ripple Rejection (Note6)	PSRR	$V_{IN}=V_{OUT}+1V$ $f_{RIPPLE} = 120Hz, C_{OUT} = 1\mu F$		60		dB	
Temperature Coefficient (Note6)	T.C.	$I_{OUT} = 1mA, V_{IN} = 5V$		50		ppm/°C	
Thermal Shutdown Temperature (Note6)	T_{SD}			160		°C	
	ΔT_{SD}	Hysteresis		25		°C	

Note 4 : The dropout voltage is defined as $V_{IN}-V_{OUT}$, which is measured when V_{OUT} drops 2% of its normal value with the specified output current.

Note 5 : Load regulation and dropout voltage are measured at a constant junction temperature by using a 40ms low duty cycle current pulse.

Note 6 : Guarantee by design.

Typical Performance Curves

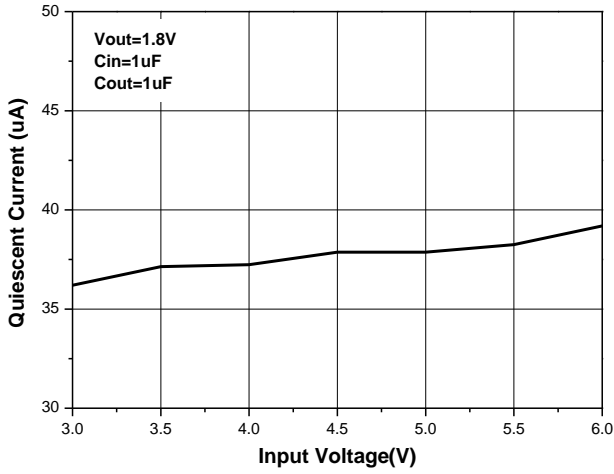

Figure 4. Quiescent Current vs. Input Voltage

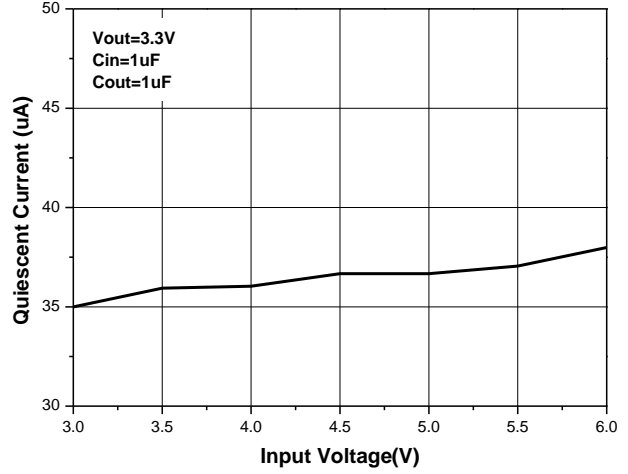

Figure 5. Quiescent Current vs. Input Voltage

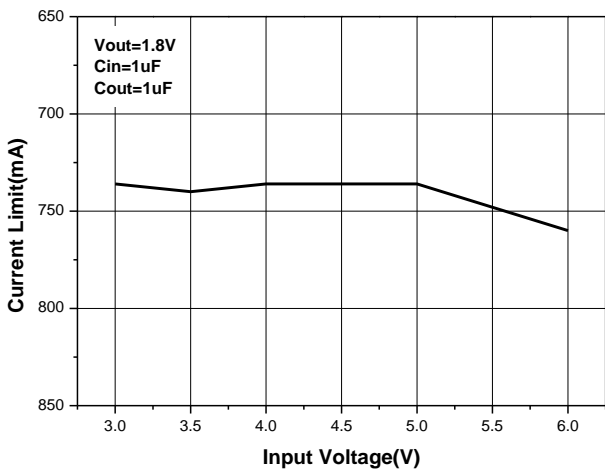

Figure 6. Current limit vs. Input Voltage

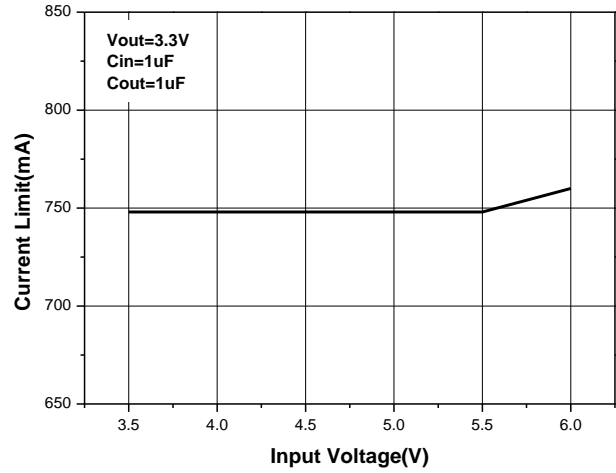

Figure 7. Current Limit vs. Input Voltage

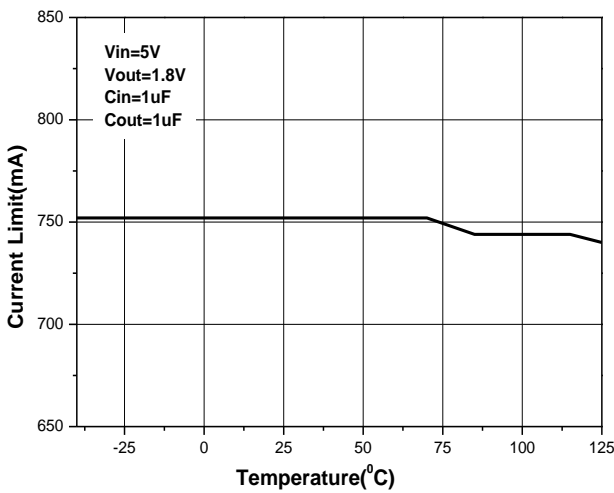

Figure 8. Current limit vs. Temperature

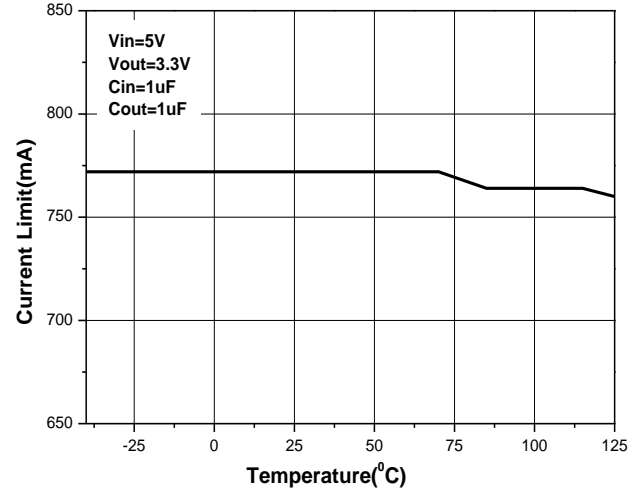

Figure 9. Current limit vs. Temperature

Typical Performance Curves (Continued)

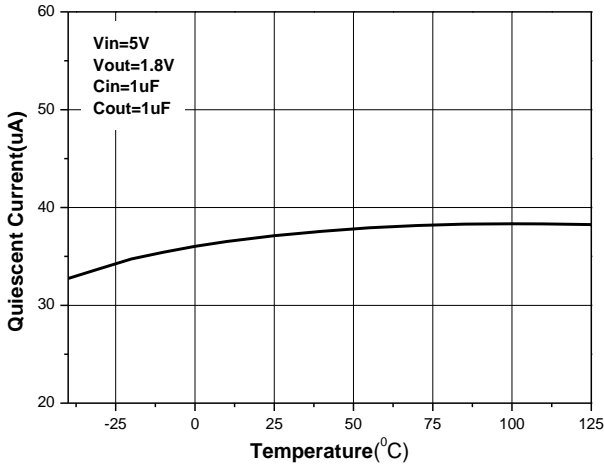

Figure 10. Quiescent Current vs. Temperature

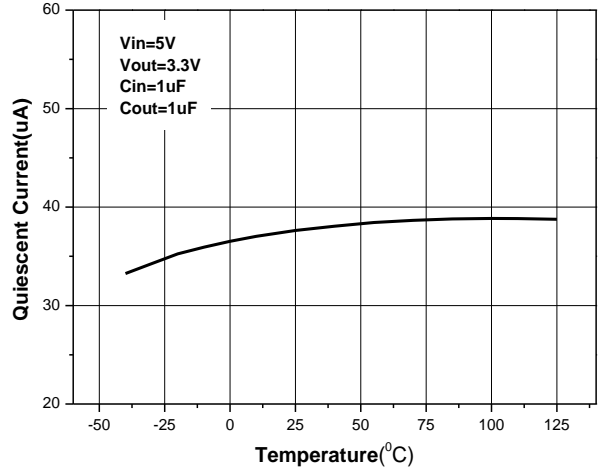

Figure 11. Quiescent Current vs. Temperature

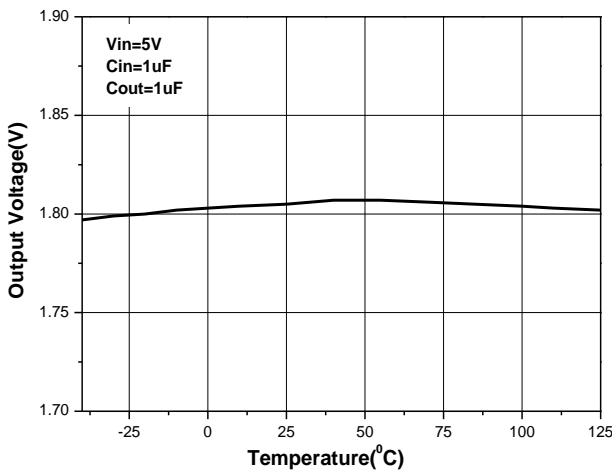

Figure 12. Temperature Stability

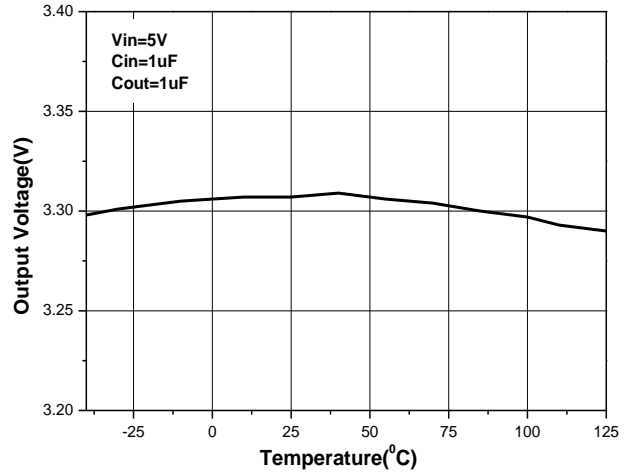

Figure 13. Temperature Stability

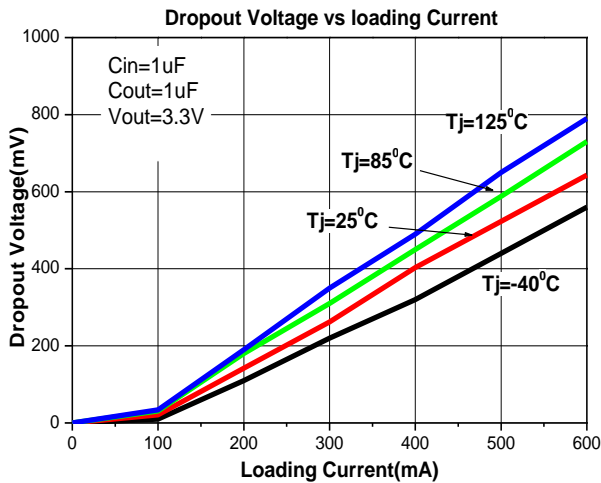

Figure 14. Dropout Voltage vs. Loading Current

Typical Performance Curves (Continued)

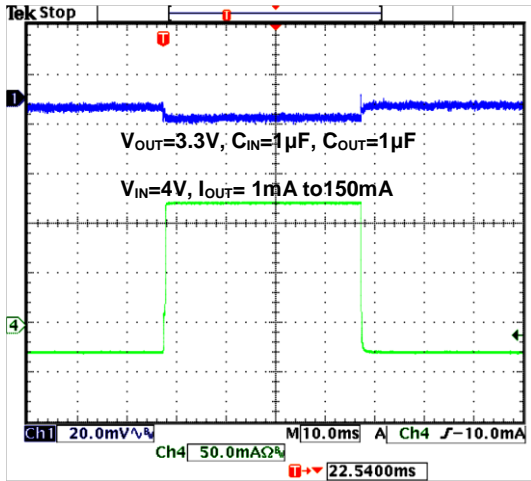

Figure 15. Load Transition Response

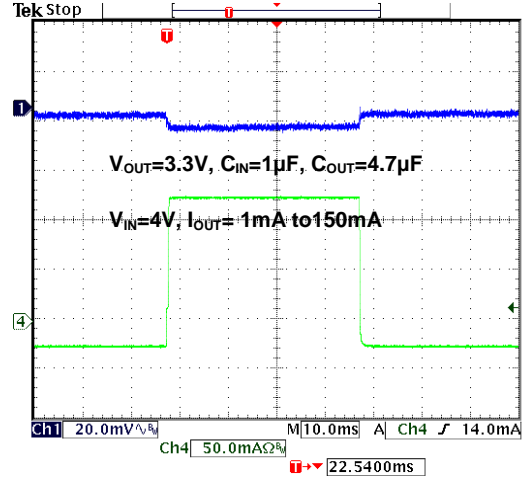

Figure 16. Load Transition Response

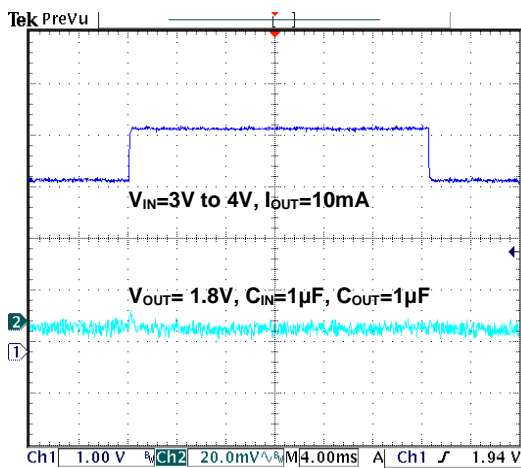

Figure 17. Line Transition Response

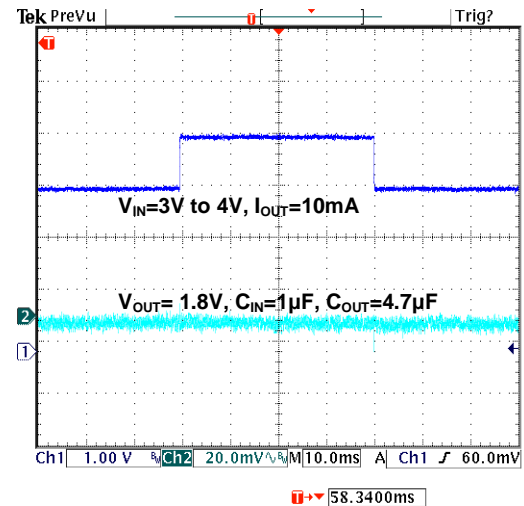

Figure 18. Line Transition Response

Application Information

The FP6130 series are low dropout linear regulators which could provide 600mA output current at dropout voltage about 600mV. Besides, current limit and on chip thermal shutdown features provide protection against overload or any condition when the ambient temperature exceeds the junction temperature.

Output and Input Capacitor

The FP6130 regulator is designed to be stable with wide range of output capacitors. The ESR of the output capacitor affects stability. Larger value of the output capacitor decreases the peak deviations and improves transition response for larger current changes.

The capacitor types (aluminum, ceramic, and tantalum) have different characterizations such as temperature and voltage coefficients. All ceramic capacitors are manufactured with a variety of dielectrics, each with different behavior across temperature and applications. Common dielectrics used are X5R, X7R and Y5V. It is recommended to use 1 μ F to 10 μ F X5R or X7R dielectric ceramic capacitors with 30m Ω to 50m Ω ESR range between device outputs to ground for transient stability. The FP6130 is designed to be stable with low ESR ceramic capacitors and higher values of capacitors, and ESR could improve output stability.

So the ESR of output capacitor is very important because it generates a zero to provide phase lead for loop stability.

There are no requirements for the ESR on the input capacitor, but its voltage and temperature coefficient have to be considered for device application environment.

Protection Feature

In order to prevent overloading or thermal condition from damaging device, FP6130 regulator has internal thermal and current limit functions designed to protect the device. It will rapidly shut off PMOS pass element during over temperature condition.

Thermal Consideration

The power handling capability of the device will be limited by allowable operation junction temperature (125°C). The power dissipated by the device will be estimated by $P_D = I_{OUT} \times (V_{IN} - V_{OUT})$. The power dissipation should be lower than the maximum power dissipation listed in "Absolute Maximum Ratings" section.

Outline Information

SOT-223 Package (Unit: mm)

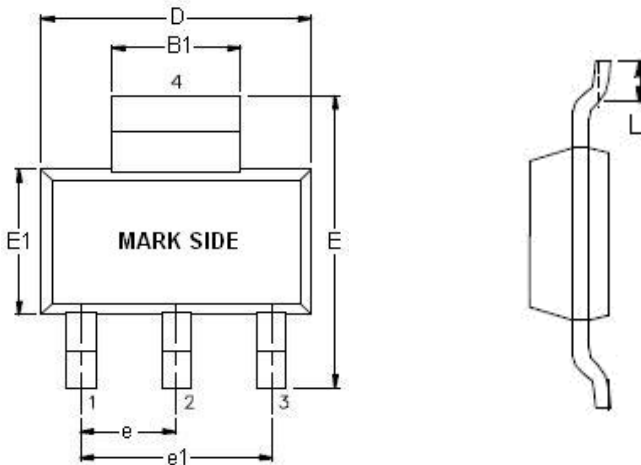

SYMBOLS UNIT	DIMENSION IN MILLIMETER	
	MIN	MAX
A	1.55	1.80
A1	0.05	0.10
A2	1.50	1.70
B	0.60	0.84
B1	2.85	3.10
D	6.30	6.70
E1	3.30	3.70
E	6.70	7.30
e	2.20	2.40
e1	4.50	4.70
L	0.75	0.85

Note : Followed From JEDEC TO-261-C.

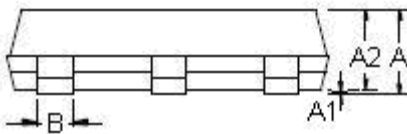

Carrier Dimensions

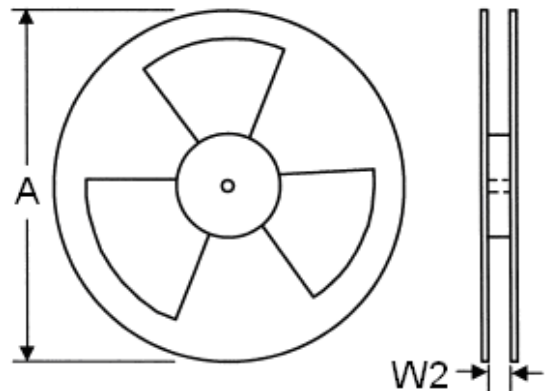
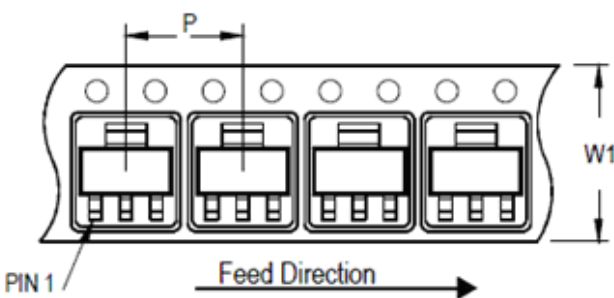

Tape Size (W1) mm	Pocket Pitch (P) mm	Reel Size (A)		Reel Width (W2) mm	Empty Cavity Length mm	Units per Reel
		in	mm			
12	8	13	330	12.4	300~1000	3,000

Life Support Policy

Fitipower's products are not authorized for use as critical components in life support devices or other medical systems.