

23V, 2A, 600KHz Asynchronous Synchronous Step-Down DC/DC Converter

Description

The FR9701 is a monolithic step-down switch mode converter with a built-in power MOSFET. It achieves 2A output current over a wide input supply range with excellent load and line regulation. Current mode operation provides fast transient response and eases loop stabilization. Fault condition protection includes cycle-by-cycle current limit and over temperature protection.

The FR9701 requires a minimum number of available standard external components. The FR9701 is available in TSOT-23-6 and SOT-23-6 packages.

Features

- 2A Output Current
- 180mΩ Internal Power MOSFET Switch
- Stable with Low ESR Output Ceramic Capacitors
- Up to 92% Efficiency
- Fixed 600KHz Frequency
- Current Mode Operation
- Over-Temperature Protection with Hiccup-Mode
- Cycle-by-Cycle Over Current Protection
- Wide 4.5V to 23V Operating Input Range
- Output Adjustable from 0.805V to 15V
- 10μA Shutdown Current
- Available in TSOT-23-6 and SOT-23-6 Packages

Applications

- Battery Charger
- Pre-Regulator for Linear Regulator
- OLPC, Netbook
- Distributed Power System
- WLED Driver

Pin Assignments

S6 Package (SOT-23-6)

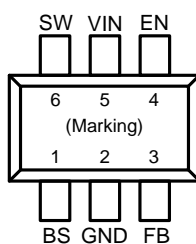

S9 Package (TSOT-23-6)

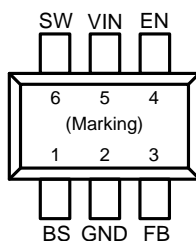

Ordering Information

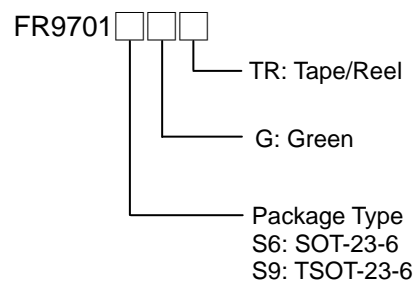

SOT-23-6 Marking

Part Number	Product Code
FR9701S6G	t7G

TSOT-23-6 Marking

Part Number	Product Code
FR9701S9G	t8G

Figure 1. Pin Assignment of FR9701

Typical Application Circuit

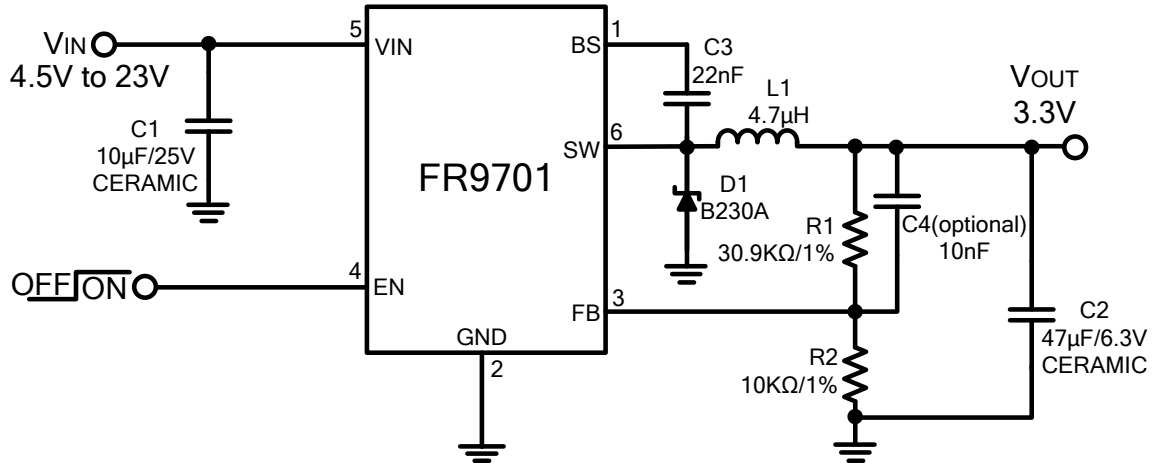

Figure 2. Output 3.3V Application Circuit

Functional Pin Description

Pin Name	Pin Function
BS	Bootstrap. A 22nF capacitor is connected between SW and BS pins to drive the power switch's gate above the supply voltage.
GND	Ground Pin.
FB	Feedback. An external resistor divider from the output to GND, tapped to the FB pin sets the output voltage.
EN	On/Off Control Input. Pull EN above 1.2V and below 5V to turn the device on.
VIN	Power Supply Input. Drive 4.5V to 23V voltage to this pin to power on this chip. Connect a 10μF ceramic bypass capacitor between VIN and GND to eliminate noise.
SW	Switch Output. Connect this pin to the switch end of the inductor.

Block Diagram

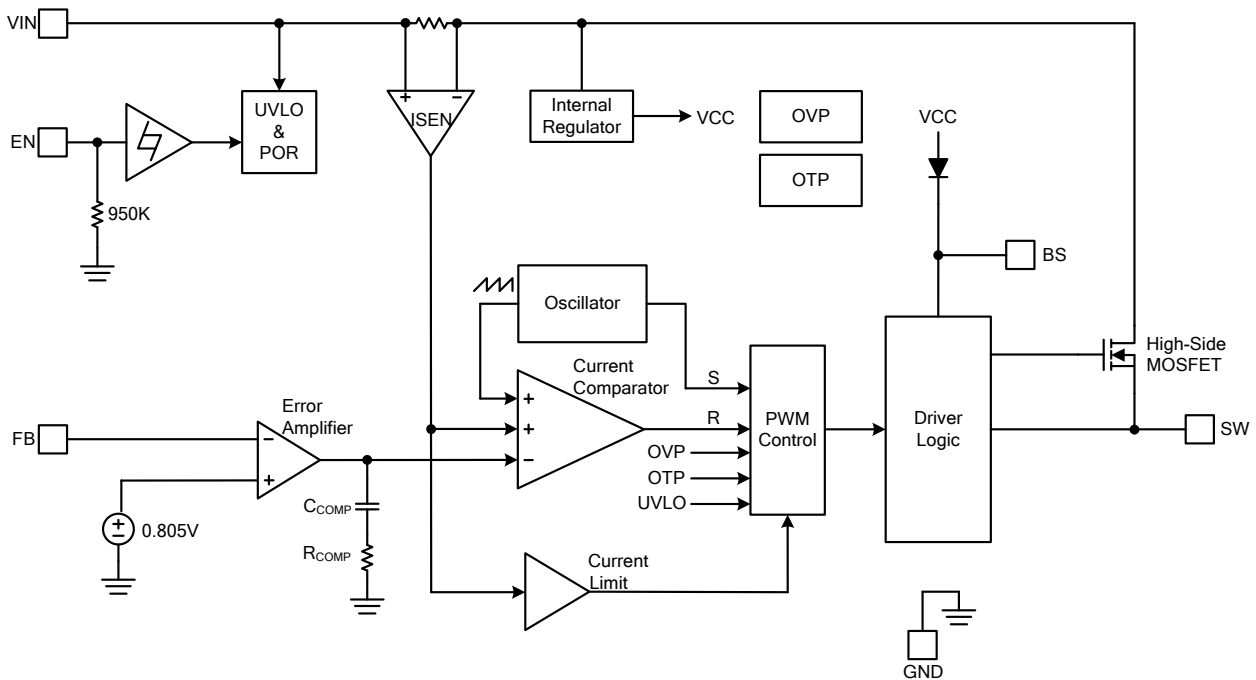

Figure 3. Block Diagram of FR9701

Absolute Maximum Ratings

- Input Supply Voltage (V_{IN}) ----- +25V
- V_{SW} ----- -0.3V to $V_{IN} + 0.3V$
- V_{BS} ----- $V_{sw} + 6V$
- All Other Pins Voltage ----- -0.3V to +6V
- Maximum Junction Temperature (T_J) ----- +150°C
- Storage Temperature (T_S) ----- -65°C to +150°C
- Lead Temperature (Soldering, 10sec.) ----- +260°C
- Power Dissipation @ $T_A=25^\circ C$, (P_D)
 - SOT-23-6 ----- +0.4W
 - TSOT-23-6 ----- +0.4W
- Package Thermal Resistance, (θ_{JA})
 - SOT-23-6 ----- +250°C/W
 - TSOT-23-6 ----- +250°C/W
- ESD Susceptibility
 - HBM (Human Body Mode) ----- 2KV

Note 1 : Stresses exceed those ratings may damage the device.

Recommended Operating Conditions

- Input Supply Voltage (V_{IN}) ----- +4.5V to +23V
- Output Voltage (V_{OUT}) ----- +0.805V to +15V
- Operation Temperature Range ----- -40°C to +85°C

Note 2 : If out of its operation conditions, the device is not guaranteed to function.

Electrical Characteristics

($V_{IN}=12V$, $T_A=25^{\circ}C$, unless otherwise specified.)

Parameter	Test Conditions	Min	Typ	Max	Unit
Feedback Voltage	$4.5V \leq V_{IN} \leq 23V$	0.785	0.805	0.825	V
Switch-On Resistance (*)			180		m Ω
Switch Leakage	$V_{EN} = 0V$, $V_{SW} = 0V$			10	μA
Current Limit (*)			3		A
Oscillator Frequency		480	600	720	KHz
Fold-back Frequency	$V_{FB} = 0V$		120		KHz
Maximum Duty Cycle			85		%
Minimum On-Time (*)			100		ns
Under Voltage Lockout Threshold Rising		4.1	4.4	4.7	V
Under Voltage Lockout Threshold Hysteresis			250		mV
EN Input Low Voltage				0.4	V
EN Input High Voltage		1.2			V
EN Input Current	$V_{EN} = 2V$		2.0		μA
	$V_{EN} = 0V$		0.1		μA
Supply Current (Shutdown)	$V_{EN} = 0V$		10		μA
Supply Current (Quiescent)	$V_{EN} = 2V$, $V_{FB} = 1V$		1.8		mA
Over-Temperature Protection Threshold (*)			150		$^{\circ}C$

* Guaranteed by design

Note 3 : $V_{IN} = 5V$, $V_{OUT} = 3.3V$, maximum load current is about 1.4A.

Typical Performance Curves

$V_{IN} = 12V$, $V_{OUT} = 3.3V$, $C1 = 10\mu F$, $C2 = 47\mu F$, $L1 = 4.7\mu H$, $T_A = +25^\circ C$, unless otherwise noted.

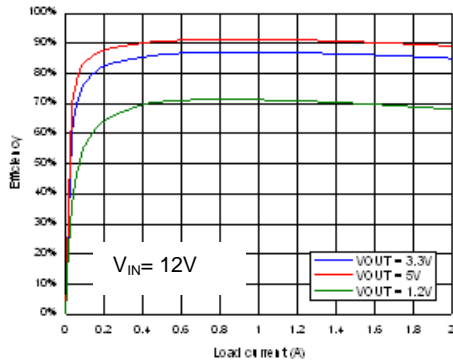

Figure 4. Efficiency vs. Loading

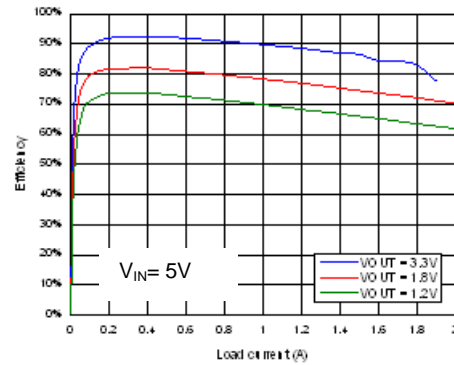

Figure 5. Efficiency vs. Loading

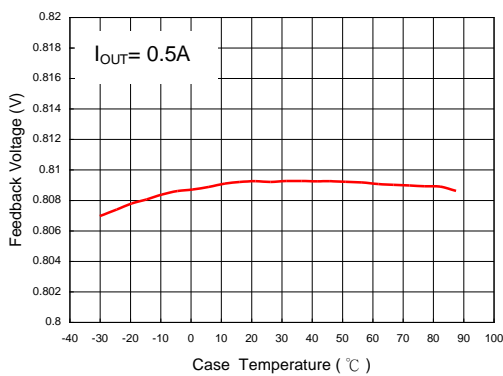

Figure 6. Feedback Voltage vs. Case Temperature

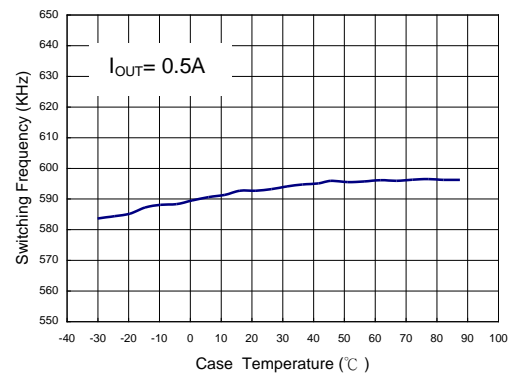

Figure 7. Switching Frequency vs. Case Temperature

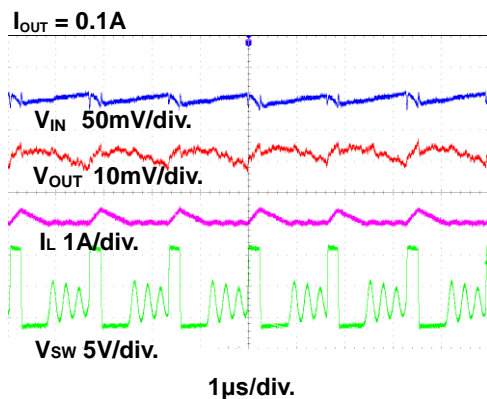

Figure 8. DC Ripple Waveform

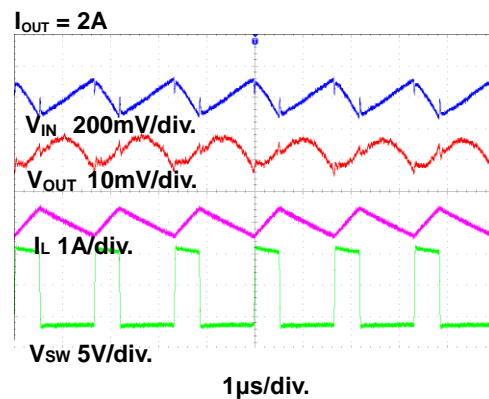

Figure 9. DC Ripple Waveform

Typical Performance Curves (Continued)

$V_{IN} = 12V$, $V_{OUT} = 3.3V$, $C1 = 10\mu F$, $C2 = 47\mu F$, $L1 = 4.7\mu H$, $T_A = +25^\circ C$, unless otherwise noted.

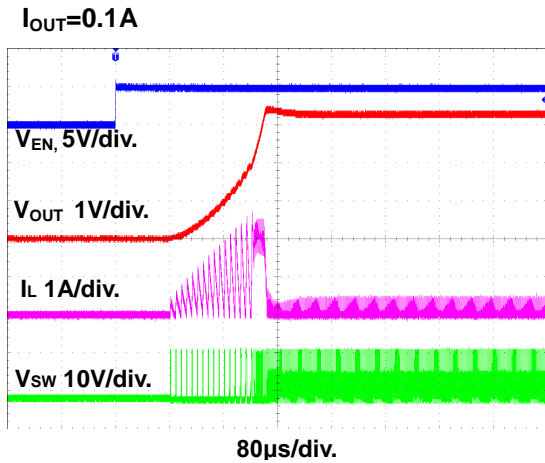

Figure 10. Startup Through Enable Waveform

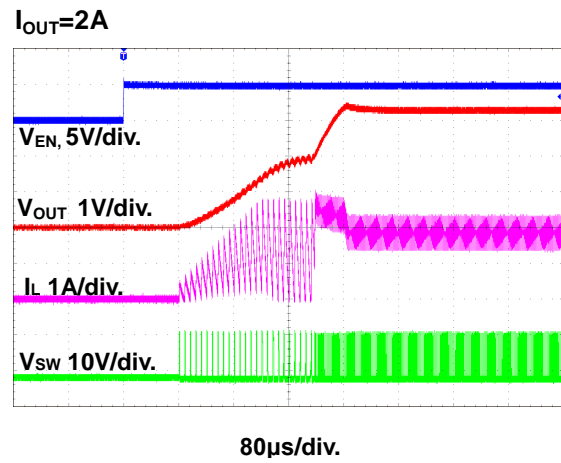

Figure 11. Startup Through Enable Waveform

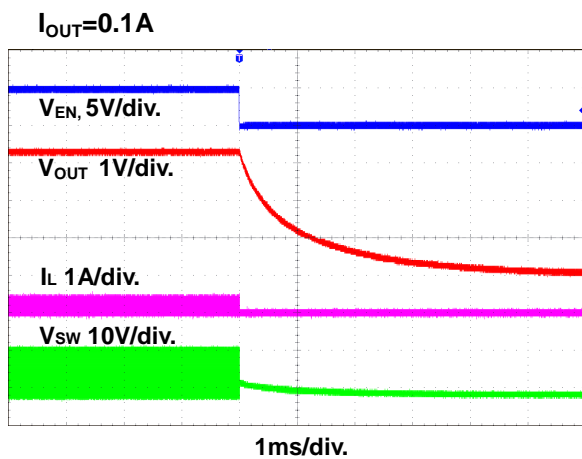

Figure 12. Shutdown Through Enable Waveform

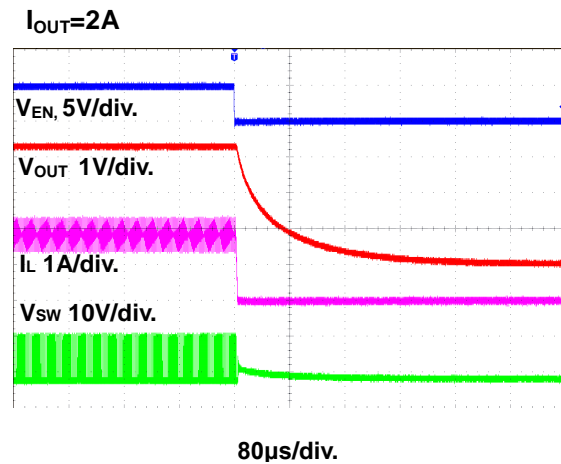

Figure 13. Shutdown Through Enable Waveform

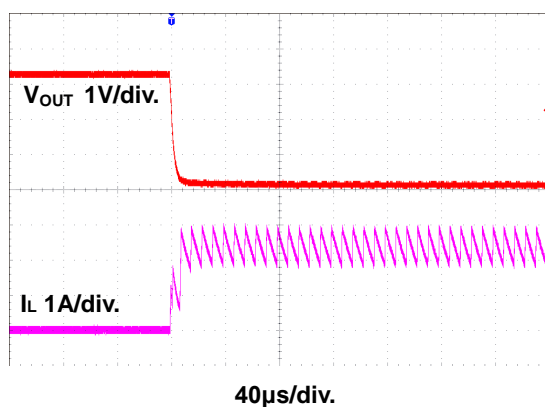

Figure 14. Short Circuit Test Waveform

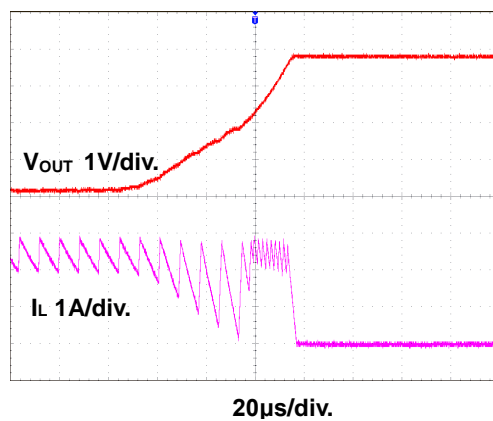

Figure 15. Short Circuit Recovery Waveform

Typical Performance Curves (Continued)

$V_{IN} = 12V$, $V_{OUT} = 3.3V$, $C1 = 10\mu F$, $C2 = 47\mu F$, $L1 = 4.7\mu H$, $T_A = +25^\circ C$, unless otherwise noted.

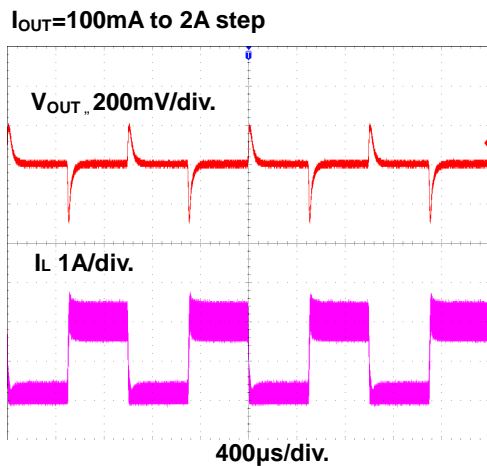
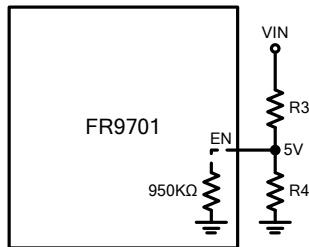

Figure 16. Load Transient Waveform

Application Information

Setting EN Automatic Startup Voltage



The external resistor divider is used to set the EN automatic startup voltage:

$$R4 = \frac{V_{EN}}{\left(\frac{V_{IN} - V_{EN}}{R3}\right)}$$

For example, $V_{IN} = 12V$, $R3 = 100k\Omega$, thus $R4$ resistor value is:

$$R4 = \frac{5V}{\left(\frac{12V - 5V}{100k\Omega}\right)} \approx 71.5k\Omega$$

Table 1 shows a list of resistor selection for common input voltages:

Table 1 -- Resistor Selection for Common Input Voltages

V_{IN}	R3	R4
5V	100k Ω	NC
12V	100k Ω	71.5k Ω
16V	100k Ω	45.3k Ω

Setting Output Voltage

The external resistor divider is used to set the output voltage. FR9701 feedback resistors are unconcerned of compensation and provide an easy way to program output voltage. Table 2 shows a list of resistor selection for common output voltages:

$$V_{OUT} = 0.805 \times \left(1 + \frac{R1}{R2}\right) V$$

Table 2 -- Resistor Selection for Common Output Voltages

V_{OUT}	R1	R2
5V	43k Ω	8.2k Ω
3.3V	30.9k Ω	10k Ω
2.5V	21k Ω	10k Ω
1.8V	12.4k Ω	10k Ω
1.2V	4.99k Ω	10k Ω

Selecting the Inductor

A 4.7 μ H inductor with a DC current rating of at least 25% percent higher than the maximum load current is recommended for most applications. For highest efficiency, the inductor's DC resistance should be less than 200m Ω . For most designs, the required inductance value can be derived from the following equation.

$$\Delta I = 0.3 \times I_{L(MAX)}$$

$$L \geq (V_{IN} - V_{OUT}) \times \left(\frac{V_{OUT}}{F_{SW} \times \Delta I \times V_{IN}}\right)$$

Where ΔI is the inductor ripple current.

Choose the inductor ripple current to be 30% of the maximum load current. The maximum inductor peak current is calculated from:

$$I_{L(MAX)} = I_{LOAD} + \frac{\Delta I_L}{2}$$

Under light load conditions below 100mA, a larger inductance is recommended for improving efficiency.

Application Information (Continued)

Selecting the Input Capacitor

The input capacitor reduces the surge current drawn from the input supply and the switching noise from the device. The input capacitor impedance at the switching frequency should be less than the input source impedance to prevent high frequency switching current from passing through the input. Ceramic capacitors with X5R or X7R dielectrics are highly recommended because of their low ESR and small temperature coefficients. For most applications, a 10 μ F capacitor is sufficient.

Selecting the Output Capacitor

The output capacitor keeps the output voltage ripple small, and a 47 μ F ceramic capacitor with X5R or X7R dielectrics is recommended for its low ESR characteristics.

External Bootstrap Diode

An external bootstrap diode is recommended if the input voltage is less than 5V or if there is a 5V system rail available. This diode helps improving the efficiency. Low cost diodes, such as 1N4148, are suitable for this application.

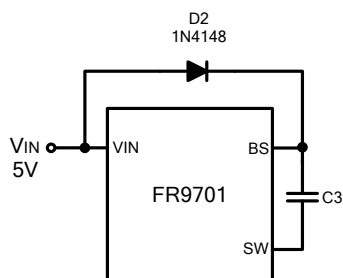

Rectifier Diode

Use a Schottky diode as the rectifier to conduct current when the high-side power MOSFET is off. The Schottky diode must have current rating higher than the maximum output current and the reverse voltage rating higher than the maximum input voltage.

PCB Layout Recommendation

The device's performance and stability are dramatically affected by PCB layout. It is recommended to follow these general guidelines shown as below:

1. Place the input capacitors and output capacitors as close to the device as possible. The traces which connect to these capacitors should be as short and wide as possible to minimize parasitic inductance and resistance.
2. Place V_{IN} capacitors close to the V_{IN} pin.
3. Place feedback resistors close to the FB pin.
4. Keep the sensitive signal (FB) away from the switching signal (SW).

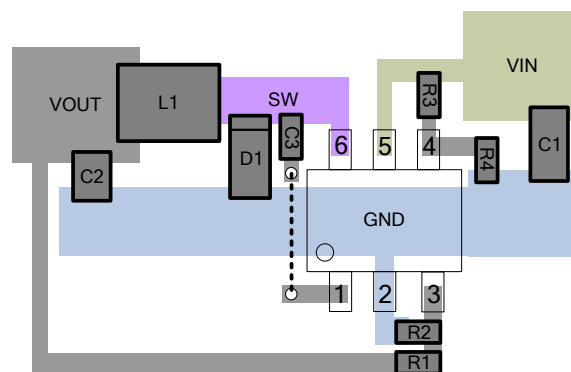
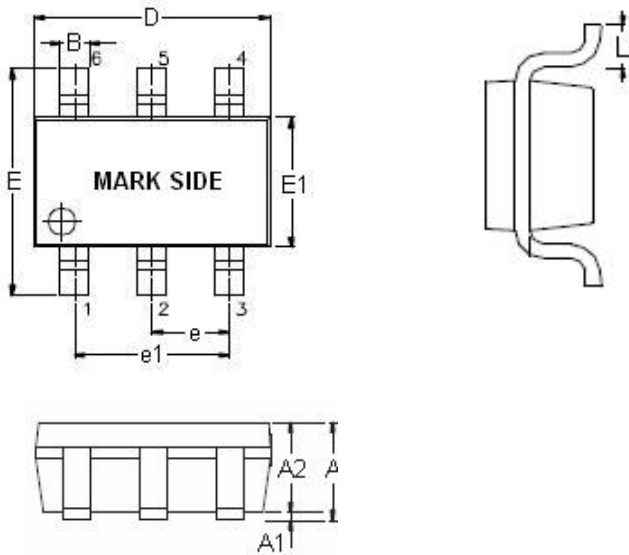

Figure 17. FR9701 Recommended Layout Diagram

Outline Information

SOT-23-6 Package (Unit: mm)



SYMBOLS UNIT	DIMENSION IN MILLIMETER	
	MIN	MAX
A	0.90	1.45
A1	0.00	0.15
A2	0.90	1.30
B	0.30	0.50
D	2.80	3.00
E	2.60	3.00
E1	1.50	1.70
e	0.90	1.00
e1	1.80	2.00
L	0.30	0.60

Note : Followed From JEDEC MO-178-C.

Carrier dimensions

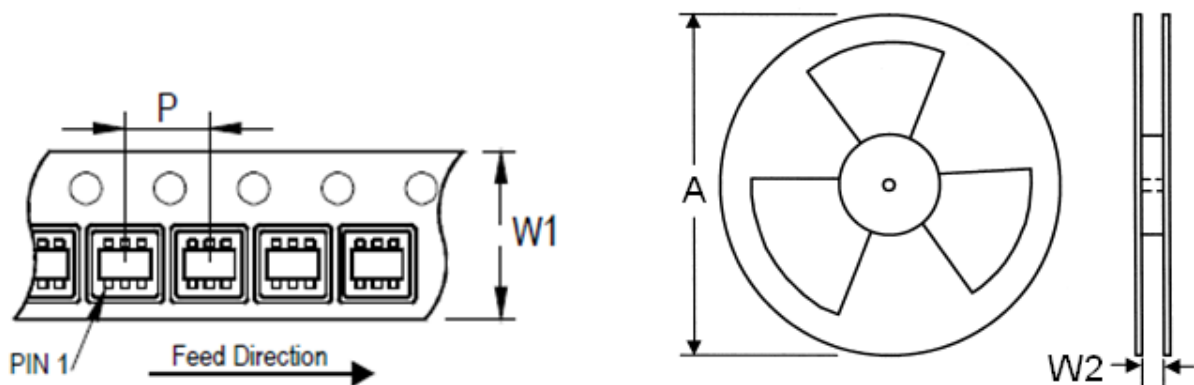

Tape Size (W1) mm	Pocket Pitch (P) mm	Reel Size (A)		Reel Width (W2) mm	Empty Cavity Length mm	Units per Reel
		in	mm			
8	4	7	180	8.4	300~1000	3,000

Outline Information

TSOT-23-6 Package (Unit: mm)

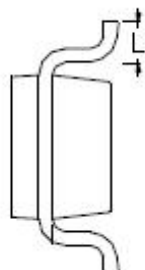
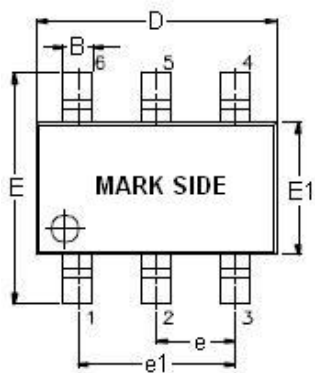

SYMBOLS UNIT	DIMENSION IN MILLIMETER	
	MIN	MAX
A	0.70	1.10
A1	0.00	0.10
A2	0.70	1.00
B	0.30	0.50
D	2.80	3.00
E	2.60	3.00
E1	1.50	1.70
e	0.90	1.00
e1	1.80	2.00
L	0.30	0.60

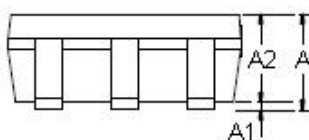

Carrier dimensions

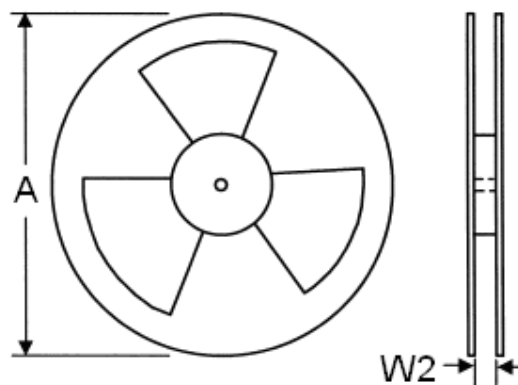
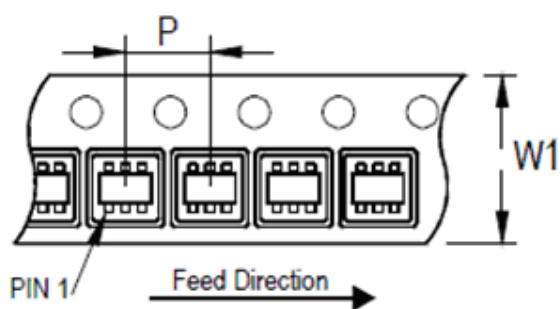

Tape Size (W1) mm	Pocket Pitch (P) mm	Reel Size (A)		Reel Width (W2) mm	Empty Cavity Length mm	Units per Reel
		in	mm			
8	4	7	180	8.4	300~1000	3,000

Life Support Policy

Fitipower's products are not authorized for use as critical components in life support devices or other medical systems.