



### Typical Features

- ◆ Wide input voltage range 85-305VAC/120-430VDC
- ◆ No load power consumption ≤ 0.45W
- ◆ Transfer efficiency 86%(typical)
- ◆ Switching frequency 65KHz
- ◆ Protections: short circuit, over current
- ◆ Isolation Voltage 4000Vac
- ◆ Conform to IEC60950/UL60950/EN60950 test standard
- ◆ Plastic case, meet flammability UL94 V-0
- ◆ PCB Mounting, chassis mounting, din-rail mounting



### Application Field

**FA30-220SXXH2D4 Series**-----a compact size, high efficient, power converter offered by Aipu.

It features universal input voltage range, taking both DC and AC input, low ripple, low temperature rise, low power consumption, high efficiency, high reliability, safer isolation, with good EMC performance. EMC and Safety specification meet international EN55032, IEC/EN61000 standard. It is widely used in power, industrial, instrument, smart home applications. Please refer to this datasheet when module being used in a bad EMC environment.

### Typical Product List

Certificate	Part No.	Output Specification					Max. Capacitive Load	Ripple & Noise 20MHz (Max)	Efficiency @full load 220Vac (TYP)
		Power	Voltage 1	Current 1	Voltage 2	Current 2			
		(W)	Vo1(V)	Io1(mA)	Vo2(V)	Io2(mA)			
/	FA30-220S05H2D4	25	5	5000	-	-	2000	120	78
	FA30-220S09H2D4	30	9	3333	-	-	2000	100	80
	FA30-220S12H2D4	30	12	2500	-	-	1000	100	82
	FA30-220S15H2D4	30	15	2000	-	-	1000	100	83
	FA30-220S18H2D4	30	18	1667	-	-	600	120	85
	FA30-220S24H2D4	30	24	1250	-	-	500	150	85

Note 1: Due to space limitations, above is only a part of our product list, please contact our sales team for more items.

Note 2: "\*" are models under developing.

Note 3: The typical value of output efficiency is based on product is full loaded and burned-in after half an hour.

Note 4: Fluctuation range of full load efficiency (% ,TYP) is ±2%. Full load efficiency=Total output power / module's Input power.

Note 5: Ripple& Noise is tested by Twisted Pair Method, details please see Ripple& Noise Test at back.

### Input Specifications

Items	Operating Conditions	Min.	Typ.	Max.	Unit
Input Voltage Range	AC input	85	220	305	VAC
	DC input	120	310	430	VDC



Input Frequency Range	-	47	50	63	Hz
Input Current	115VAC	/	/	0.65	A
	220VAC	/	/	0.37	
Surge Current	115VAC	/	/	10	
	220VAC	/	/	20	
Leakage Current	-	0.5mA TYP/230VAC/50Hz			
Recommended External Input Fuse	-	1A-3A/250VAC, slow-fusing			
Hot Plug	-	Unavailable			
Remote Control Terminal	-	Unavailable			

**Output Specifications**

Items	Operating Conditions		Min.	Typ.	Max.	Unit
Voltage Accuracy	Full input voltage range, any load	Vo1	-	±2.0	±3.0	%
		Vo2	-	-	-	%
Line Regulation	Nominal load	Vo1	-	-	±0.5	%
		Vo2	-	-	-	%
Load Regulation	Nominal input voltage, 20%~100% load	Vo1	-	-	±2.0	%
		Vo2	-	-	-	%
No Load Power Consumption	Input 115VAC		-	-	0.45	W
	Input 220VAC		-	-		
Minimum Load	Single Output		10	-	-	%
	Dual Output Common Ground		-	-	-	%
	Dual Output but Isolated		-	-	-	
Start-up Delay Time	Nominal input voltage (full load)		-	2000	-	mS
Power-off Holding Time	Input 115VAC(full load)		-	200	-	mS
	Input 220VAC(full load)		--	100	-	
Dynamic Response	25%~50%~25%		Overshoot range(%):≤±5.0			%
	50%~75%~50%		Recovery time(mS):≤5.0			mS
Output Overshoot	Full input voltage range		≤10%Vo			%
Short-Circuit Protection	Full input voltage range		Continuous, Self-recovery			Hiccup
Drift Coefficient	-	-	-	±0.03%	-	%/°C
Over-current Protection	Full input voltage range		≥120% Io self-recovery			Hiccup

/



**General Specifications**

Items	Operating Conditions	Min.	Typ.	Max.	Unit
Switching Frequency	-	-	65	-	KHz
Operating Temperature	-	-40	-	+75	°C
Storage Temperature	-	-40	-	+85	
Soldering Temperature	Wave soldering	260±4°C, timing 5-10S			
	Manual soldering	360±8°C, timing 4-7S			
Relative Humidity	-	10	-	90	%RH
Isolation Voltage	Input-Output, test 1min, leakage current≤5mA	4000	-	-	VAC
Insulation Resistance	Input-Output@DC500V	100	-	-	MΩ
Safety Standard	-	EN60950, IEC60950			
Vibration	-	10-55Hz, 10G, 30Min, along X, Y, Z			
Safety Class	-	CLASS II			
MTBF	-	MIL-HDBK-217F@25°C > 300,000H			

**Physical Characteristics**

Case Material	Black flame-retardant heat-resistant plastic (UL94 V-0)	
Packing Dimension	Horizontal package	70.0X48.0X23.5 mm
Product Weight		130g(TYP)
Cooling Method	Free air convection	

**Electromagnetic Compatibility(EMC) Characteristics**

Total Items	Sub Items	Standard	Class	
EMC	EMI	CE	CISPR22/EN55032 CLASS B (see recommended circuit Photo 2)	
		RE	CISPR22/EN55032 CLASS B (see recommended circuit Photo 2)	
	EMS	RS	IEC/EN61000-4-3	10V/m Perf.Criteria B (see recommended circuit Photo 1)
		CS	IEC/EN61000-4-6	3Vr.m.s Perf.Criteria B (see recommended circuit Photo 1)
		ESD	IEC/EN61000-4-2	Contact ±6KV / Air ±8KV Perf.Criteria B
		Surge	IEC/EN61000-4-5	±1KV Perf.Criteria B
		EFT	IEC/EN61000-4-4	±2KV Perf.Criteria B
		Voltage dips, short interruptions and voltage variations immunity	IEC/EN61000-4-11	0%~70% Perf.Criteria B



**H2 Dimension**

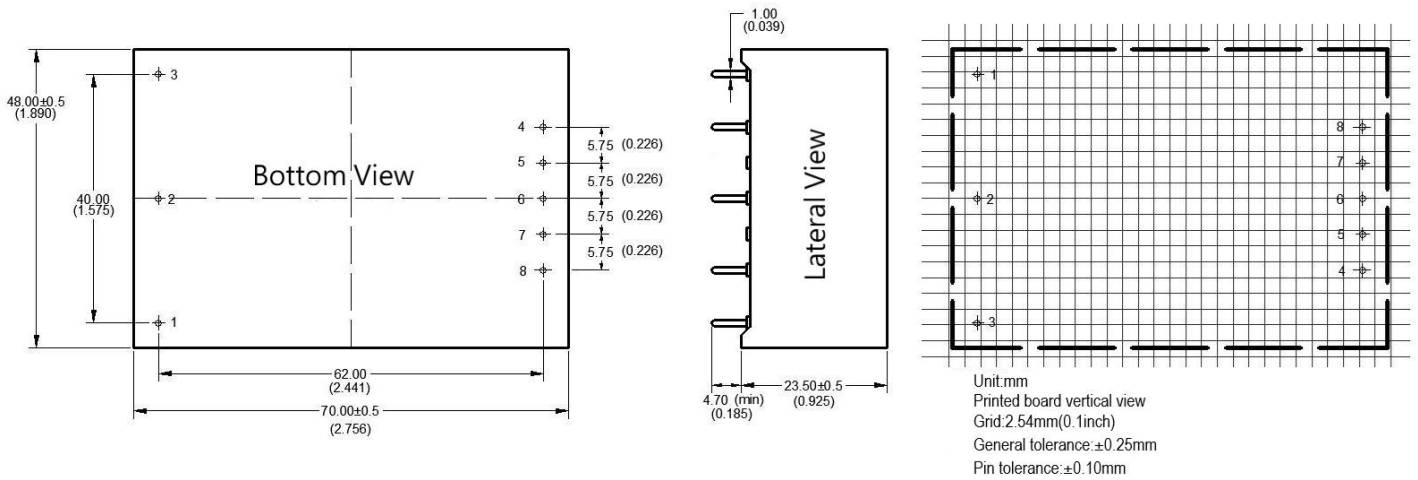

**H2-T Dimension**

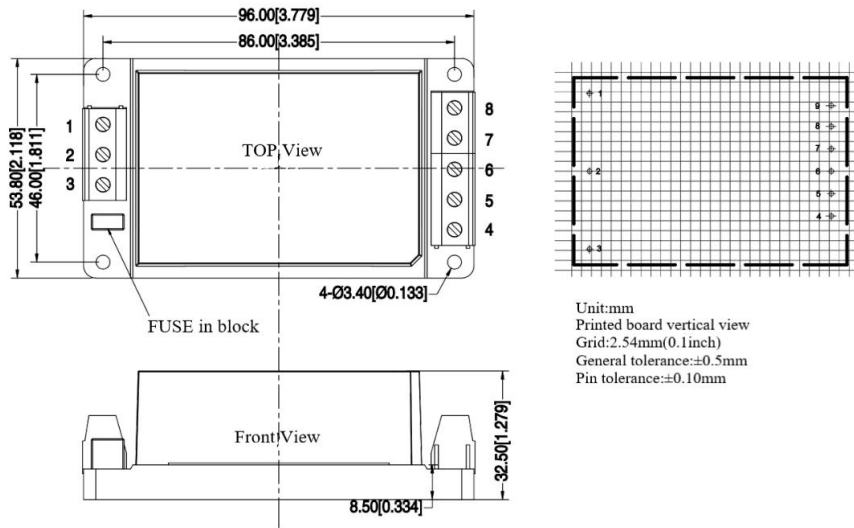

**H2-TS Dimension**

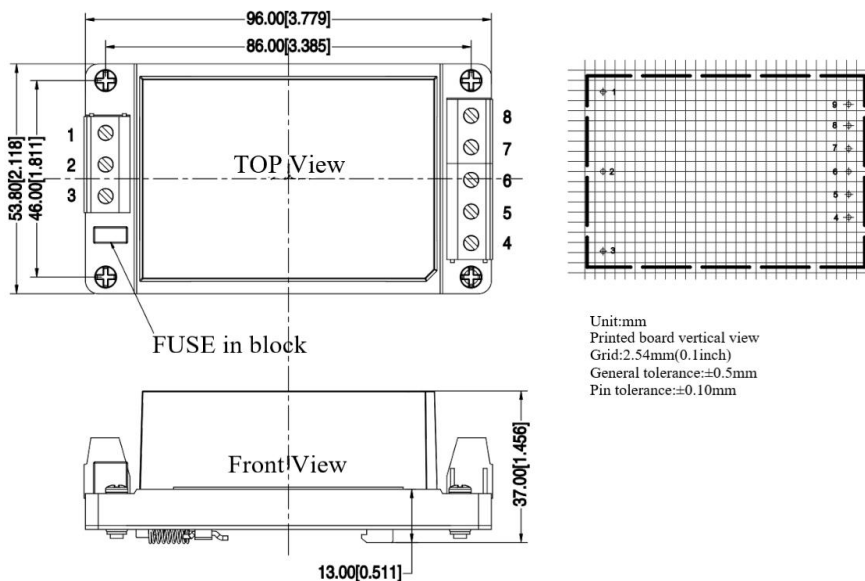

Packing Code	L x W x H	
H2	70.0 x 48.0 x 23.5 mm	2.756 × 1.890 × 0.925inch
H2-T	96.0X53.8X32.5 mm	3.779X2.118X1.279inch
H2-TS	96.0X53.8X37.0 mm	3.779X2.118X1.456inch

**Pin Definition**

Pin-out	1	2	3	4	8
Single(S)	FG	AC(N)	AC(L)	+Vo	-Vo

Note: If the definition of pin is not in accordance with the model selection manual, please refer to the label on actual item.

**Ripple & Noise Test: (Twisted Pair Method 20MHZ bandwidth)**

Test Method:

(1) 12# twisted pair to connect, Oscilloscope bandwidth set as 20MHz, 100M bandwidth probe, terminated with 0.1uF polypropylene capacitor and 10uF high frequency low resistance electrolytic capacitor in parallel, oscilloscope set as Sample pattern.

(2) Input terminal connect to power supply, output terminal connect to electronic load through jig plate, Use 30cm±2 cm sampling line, Power line selected from corresponding diameter wire with insulation according to the flow of output current.

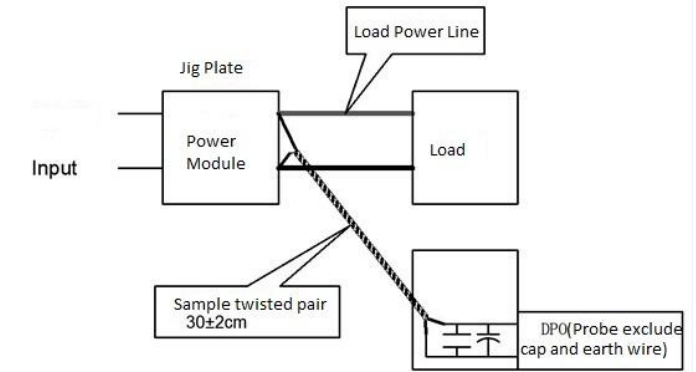

**Product Characteristic Curve**

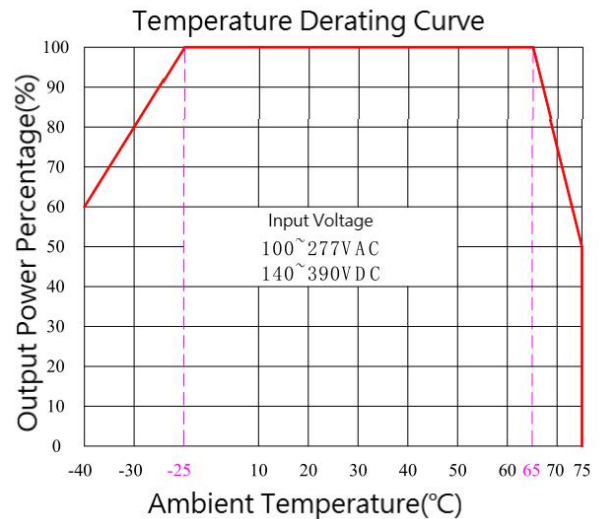
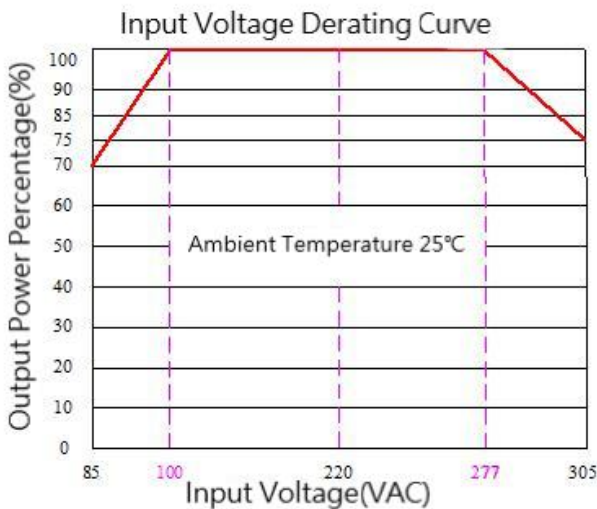

**Note**

- 1: Input Voltage should be derated base on Input Voltage Derating Curve when it is 85~100VAC/277~305VAC/120~140VDC/ 390~430VDC.
- 2: Our product is suitable to use under natural air cooling environment, if use it under closed condition, please contact with us.

**Typical EMC Application and Recommend Circuit**

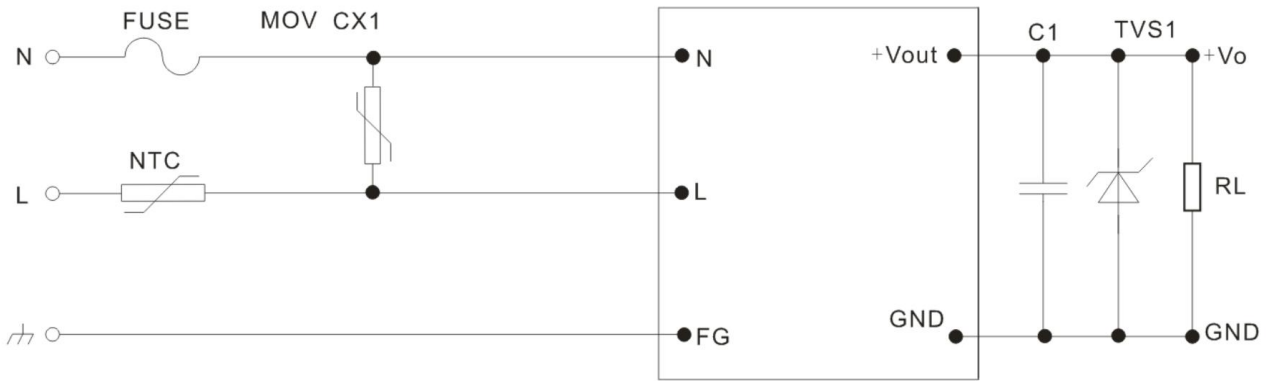

Photo 1

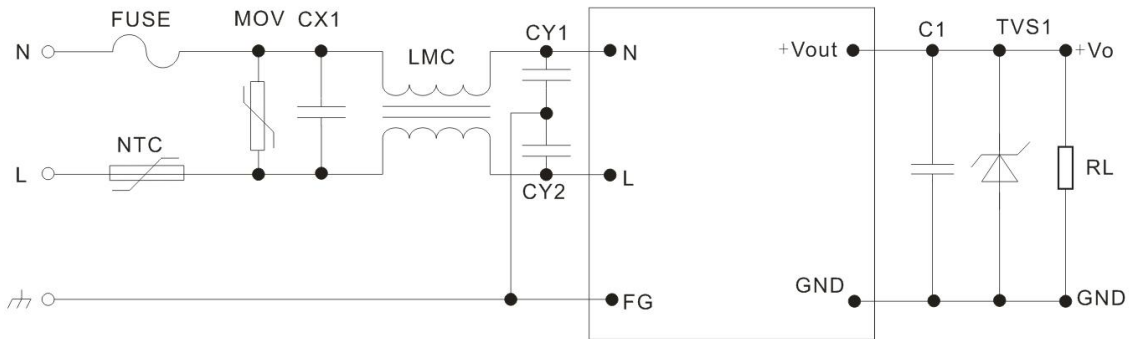

Photo 2

**Note:**

- Output filter capacitors C1 filters high frequency noise, recommend to use 1μF ceramic capacitor, capacitance withstand voltage derating should be 80% or above.
- TVS is a recommended component to protect post-circuits if converter fails, recommend to use 600W model.  
 5V output recommend: SMBJ7.0A, 9V output recommend: SMBJ12.0A, 12V output recommend: SMBJ20A, 15V output recommend: SMBJ20.0A, 24V output recommend: SMBJ30.0A, 48V output recommend: SMBJ64A.
- MOV is voltage depend resistor, recommend model: 10D561K, to protect converter from damage when lightning surge
- For customer's normal application request, use Photo 1 recommended circuit, if has higher EMC request, use Photo 2 recommended circuit. The spec for Photo 2 as below:
  - MOV: voltage dependent resistor, recommend model: 10D-561K, to protect converter from damage when lightning surge.
  - NTC: Thermistors, 10D-9;
  - CY1,CY2: safety capacitor,1000pF/400VAC;
  - CX: safety capacitor,0.1μF/275VAC;
  - LCM: common mode inductor,15mH-30mH;
  - FUSE: necessary, recommend model 3.15A/250V, slow fusing.

**Note:**

- 1.The product should be used under the specification range, otherwise it will cause permanent damage to it.
- 2.Product's input terminal should connect to fuse;
- 3.If the product operated below the minimum load request, we cannot ensure that the performance of product is in accordance with all the indexes in this manual;
- 4.If the product worked beyond the load range, we cannot ensure that the performance of product is in accordance with all the indexes in this manual;
- 5.Unless otherwise specified, data in this datasheet are tested under conditions of **Ta=25°C**, **humidity<75%** when inputting nominal voltage and outputting rated load(pure resistance load);
- 6.All index testing methods in this datasheet are based on our Company's corporate standards.
- 7.The performance indexes of the product models listed in this manual are as above, but some indexes of non-standard model products will exceed the above-mentioned requirements, please directly contact our technician for specific information;
- 8.We can provide customized product service;
- 9.The product specification may be changed at any time without prior notice.